

# Panasonic<sup>®</sup>

## User Guide

### Smartphone dL1

---

Model No. **EB-3901**

S M A R T P H O N E



**Thank you for purchasing a Panasonic smartphone.**

To ensure safe and proper operation of this product, please read the included Important Information before using this product.

# Table of Contents

|   |           |
|---|-----------|
| <b>Introduction</b> .....                                     | <b>5</b>  |
| <b>Getting started</b> .....                                  | <b>6</b>  |
| Inserting the SIM card .....                                  | 6         |
| Charging the battery .....                                    | 6         |
| Turning the phone on .....                                    | 7         |
| Configuring the phone for the first time .....                | 8         |
| <b>Getting to know your phone</b> .....                       | <b>9</b>  |
| Phone overview .....  | 9         |
| Indicator .....   | 9         |
| Navigation buttons (☰ ⬆ ⬅) .....                              | 10        |
| Using the touch panel screen .....                            | 10        |
| Switching between vertical and horizontal viewing modes ..... | 12        |
| Home screen .....   | 12        |
| Using apps .....  | 13        |
| Status and notifications .....                                | 14        |
| Typing on your phone .....                                    | 15        |
| Account settings .....  | 17        |
| Customising your phone .....                                  | 18        |
| eco mode .....  | 21        |
| Storage .....   | 22        |
| Stereo headset .....  | 22        |
| <b>Connecting to networks</b> .....                           | <b>24</b> |
| Connecting to mobile networks .....                           | 24        |
| Connecting to Wi-Fi networks .....                            | 25        |
| Using Wi-Fi Direct .....                                      | 27        |
| Creating a Wi-Fi hotspot .....                                | 27        |
| Connecting to VPNs .....                                      | 28        |
| <b>Phone</b> .....  | <b>29</b> |
| Making calls .....  | 29        |
| Using other features during a call .....                      | 30        |
| Answering calls .....   | 30        |
| Call log .....  | 31        |
| Voicemail .....   | 31        |
| Call forwarding .....   | 32        |
| Call waiting .....  | 32        |
| Conference calls .....  | 32        |
| Sending your caller information (Caller ID) .....             | 33        |
| Fixed dialling .....  | 33        |
| <b>People</b> .....   | <b>34</b> |
| Adding contacts to your phone .....                           | 34        |
| Managing your contacts .....                                  | 35        |
| Sharing and backing up contacts .....                         | 36        |
| <b>Email</b> .....  | <b>37</b> |
| Using email .....   | 37        |
| Managing email messages .....                                 | 38        |

|  |           |
|--|-----------|
| Using email accounts .....   | 39        |
| Gmail .....  | 39        |
| <b>Messaging .....</b>   | <b>40</b> |
| Using text and multimedia messaging .....  | 40        |
| Talk .....   | 42        |
| <b>Browser .....</b>   | <b>43</b> |
| Browsing the web .....   | 43        |
| Navigating web pages .....   | 43        |
| Bookmarking your favourite web pages .....                                       | 44        |
| Downloading from web pages .....   | 45        |
| Using the web browser's options menu .....                                       | 45        |
| Changing web browser settings .....  | 45        |
| <b>Play Music .....</b>  | <b>47</b> |
| Copying audio files to your phone .....  | 47        |
| Listening to your music .....  | 47        |
| Using playlists .....  | 48        |
| <b>Camera .....</b>  | <b>49</b> |
| Taking pictures and recording videos .....                                       | 49        |
| Viewing your pictures and videos .....   | 53        |
| Editing pictures .....   | 54        |
| <b>Location services .....</b>   | <b>56</b> |
| Maps .....   | 56        |
| Navigation .....   | 57        |
| Local .....  | 58        |
| <b>Other apps .....</b>  | <b>59</b> |
| NFC Starter .....  | 59        |
| Calendar .....   | 59        |
| Clock .....  | 61        |
| Notepad .....  | 61        |
| YouTube .....  | 62        |
| <b>Play Store .....</b>  | <b>64</b> |
| Finding and downloading apps .....   | 64        |
| App management .....   | 64        |
| <b>Connecting to other devices .....</b>   | <b>66</b> |
| Bluetooth wireless technology .....  | 66        |
| Android Beam .....   | 68        |
| USB connection features .....  | 68        |
| DLNA (content streaming) .....   | 69        |
| <b>Synchronise, backup, and restore .....</b>                                    | <b>71</b> |
| Synchronising with your Google or Microsoft Exchange ActiveSync<br>account ..... | 71        |
| Backing up to the USB storage .....  | 72        |
| Backing up to a computer via Wi-Fi .....   | 73        |
| Backing up to a computer via USB .....   | 73        |
| <b>Phone security .....</b>  | <b>74</b> |

|  |           |
|--|-----------|
| Locking the screen .....                                 | 74        |
| Hiding your data .....                                   | 74        |
| Protecting phone settings with a terminal password ..... | 76        |
| Protecting your SIM card .....                           | 76        |
| <b>Updating the phone .....</b>                          | <b>77</b> |
| Downloading updates wirelessly .....                     | 77        |
| Downloading updates with a computer .....                | 78        |
| <b>Phone settings overview .....</b>                     | <b>79</b> |
| <b>List of icons .....</b>                               | <b>80</b> |
| <b>Troubleshooting .....</b>                             | <b>84</b> |
| <b>Need help? .....</b>                                  | <b>88</b> |
| <b>Index.....</b>  | <b>89</b> |

# Introduction

## Product documentation

The following documentation is available for your phone.

### Important Information

Provides information about how to use your phone safely.

### Quick Start Guide

Briefly introduces you to the phone and explains how to use it for the first time.

### User Guide (this document)

Introduces you to your phone, explains how to configure and customise it, and provides information and instructions on how to use many of your phone's features.

## Trademarks

- Android™, Android Market™, Gmail™, Google™, Google Calendar™, Google Maps™, Google Play™, Google Talk™, Google Wallet™, and YouTube™ are trademarks of Google Inc.
- The *Bluetooth*® word mark and logos are registered trademarks owned by Bluetooth SIG, Inc. and any use of such marks by Panasonic Mobile Communications Co., Ltd. is under licence.
- DLNA® is a trademark, a service mark, or a certification mark of the Digital Living Network Alliance.
- Microsoft®, Windows®, Windows Vista®, and ActiveSync® are either registered trademarks or trademarks of Microsoft Corporation in the United States and/or other countries.
- Wi-Fi® is a registered mark of the Wi-Fi Alliance.
- Wi-Fi Direct™ is a mark of the Wi-Fi Alliance.
- All other trademarks identified herein are the property of their respective owners.

## Notice

- The term “apps” is used in this document to refer to programs that are installed on the phone.
- The illustrations and screenshots shown in this document are for reference only and may differ from the appearance of the actual product.
- Information in this document is subject to change without notice.

# Getting started

## Inserting the SIM card

---

Your phone's SIM card contains your phone number and service details.

### Inserting the SIM card

1. Open the SIM card slot cover on the top of the phone, and then insert the SIM card into the slot as shown.
  - Insert only a micro SIM card. Do not attempt to insert a full-size SIM card. Do not cut a full-size SIM card to convert it to a micro SIM card and attempt to insert it in the phone.
  - Note the position of the notched corner of the SIM card in the illustration below and insert the correct end of the card.

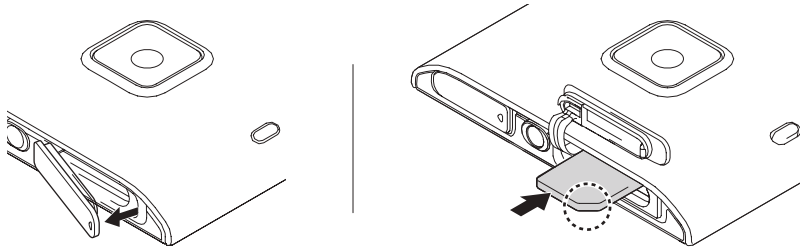

2. Close the SIM card slot cover.

### Removing the SIM card

1. Open the SIM card slot cover on the top of the phone.
2. Gently push the SIM card slightly into the phone.
3. Remove the SIM card.
4. Close the SIM card slot cover.

## Charging the battery

---

You can charge your phone by connecting it to a power outlet using the included USB cable and AC adaptor, and also by connecting it to your computer's USB port. The phone's indicator will light in red while the battery is charging, and it will turn off when charging stops or is complete.

### Note

- If your phone has never been turned on, the indicator may flash in red while it is connected to a power source. This is not a malfunction.
- If the indicator does not light within a few seconds, make sure the USB cable is connected properly to the power source (i.e., the AC adaptor or computer). If the indicator does not light after a prolonged time, contact your regional Panasonic representative. (Contact information can be found on the included Warranty Card.)

### Charging the battery using the AC adaptor

Connect your phone to a power outlet using the included USB cable and AC adaptor.

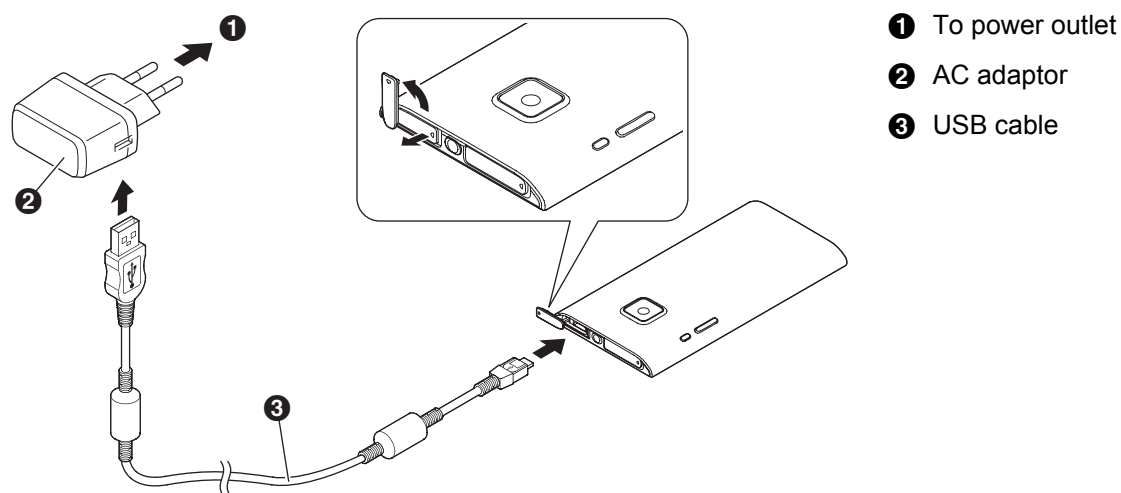

- ❶ To power outlet
- ❷ AC adaptor
- ❸ USB cable

### Charging the battery using a computer or other device

Connect your phone to the USB port of the computer or other device using the included USB cable. Make sure the computer or other device is turned on and is sending power through the USB cable.

### Saving battery power

The amount of time you can use your phone before the battery needs to be charged varies depending on how you are using the phone. Each of the following can help you save battery power.

- Use eco mode to adjust settings and limit features automatically depending on the amount of battery power remaining (“eco mode” (page 21)).
- Turn off the screen when you are not using the phone.
- Reduce the screen brightness (“Adjusting the screen brightness manually” (page 19)).
- Reduce the amount of time that passes before the screen turns off automatically (“Setting the screen timeout” (page 19)).
- Turn off the phone’s Wi-Fi, GPS, and *Bluetooth* features.
- Lower the volume when playing videos, listening to music, etc.
- Quit any apps that are running but are not in use (“Quitting an app” (page 14)).

### Checking the percentage of battery power remaining

From the Home screen, tap  → **[Settings]** → **[Battery]**.

## Turning the phone on

To turn the phone on, press and hold  (power button) on the side of the phone. When the lock screen appears, unlock the screen (see “Unlocking the screen” (page 8)).

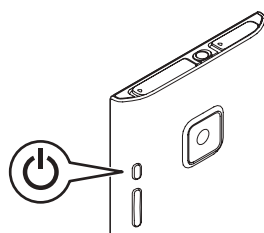

### Turning the phone on for the first time

The first time you turn on your phone, you will be prompted to configure various settings. See “Configuring the phone for the first time” (page 8) for more information.

### Turning the phone off

Press and hold  on the side of the phone and select the power off option.

### Turning the screen on and off

You can turn the screen off to save battery power and prevent accidental operation. While the screen is turned off, you can still receive calls, messages, etc. Any apps that were in use when the screen was turned off continue to run.

To turn the screen on and off, press  on the side of the phone.

### Unlocking the screen

When you turn the screen on, the lock screen may be displayed. This screen prevents you from accidentally tapping your phone and operating it unintentionally, and can also prevent unauthorised use of your phone. Several different unlock methods are available.

By default, when the lock screen is displayed you can unlock the screen by dragging the lock icon toward the unlock icon or toward the icon of the desired action. You can also configure the phone to use a more secure unlock method, such as a PIN or password (“Locking the screen” (page 74)).

## Configuring the phone for the first time

---

The first time you turn on your phone, you will be prompted to configure various settings. Follow the on-screen instructions and configure each item as needed.

### **Note**

- If you cannot read the language displayed on the screen, tap the language name displayed on the screen and then select the desired language.



# Getting to know your phone

## Phone overview

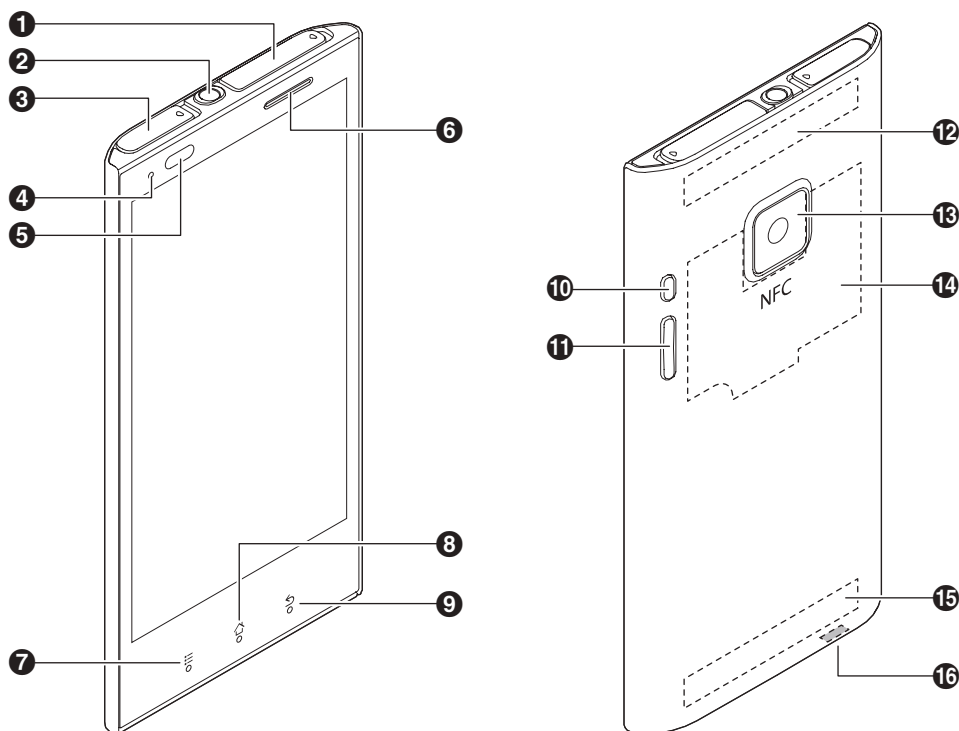

- ❶ SIM card slot cover
- ❷ Headset jack
- ❸ microUSB jack cover
- ❹ Indicator
- ❺ Light sensor, proximity sensor
- ❻ Earpiece and speaker
- ❼ ≡ (menu) button
- ❽ ⬆ (home) button
- ❾ ⬅ (back) button
- ❿ ⏻ (power) button
- ⓫ ⬇ and ⬆ (volume) buttons
- ⓬ Wi-Fi, Bluetooth, and GPS antenna
- ⓭ Camera
- ⓮ NFC antenna
- ⓯ Main antenna
- ⓰ Microphone

## Indicator

The indicator lights in red while the battery is charging and turns off when charging stops or is complete. The indicator flashes in green when a call is received, a new message is received, etc.

## Navigation buttons (☰ ☑ ⏪)

- |          |   |
|----------|---|
| ☰ (menu) | Displays a list of options available in the current screen.   |
| ☑ (home) | Displays the Home screen; tap and hold to display a list of recently used apps. Once the list is displayed, tap an app to launch it, or flick left or right to remove an app from the list. |
| ⏪ (back) | Returns to the previous screen or closes the current dialogue box, menu, on-screen keyboard, etc.   |

## Using the touch panel screen

Your phone features a touch panel screen, which you can operate by touching directly with your fingers. The gestures you can use to operate the touch panel screen are described below.

### Note

- App behaviours vary. Some of the gestures described here are not available in some apps.

### Tapping

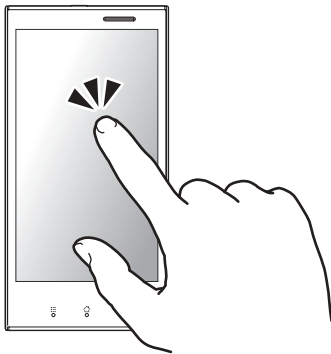

Tap an item or icon to select it.

### Double-tapping

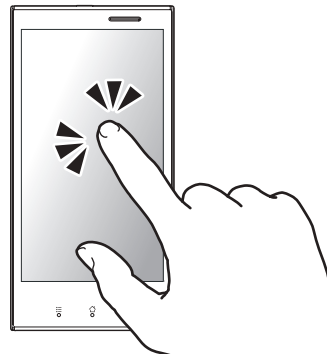

Tap the touch panel screen quickly two times to zoom in and out.

### Tapping and holding

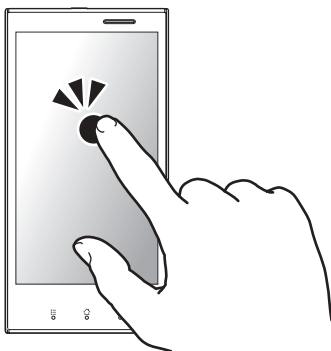

Tap an item or icon without releasing your finger from the touch panel screen to display a context menu, if available.

### Flicking

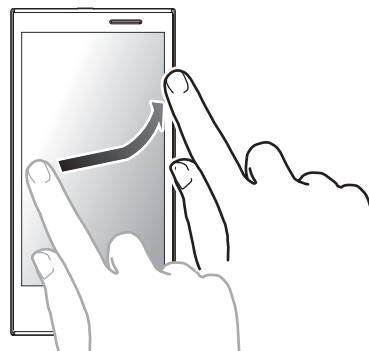

Move your finger across the touch panel screen quickly to browse through pages, pictures, etc.

### Dragging

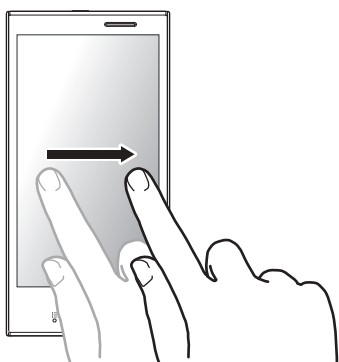

Tap an item or icon without releasing your finger from the touch panel screen and slide your finger on the touch panel screen to move the item to another place.

### Scrolling

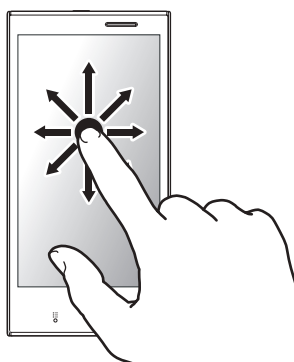

Slide your finger on the touch panel screen to scroll to a different area of the page, picture, etc.

### Pinching

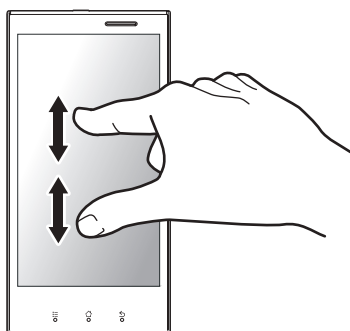

Using two fingers, “pinch” together two points on the touch panel screen to zoom out, and push apart two points on the touch panel screen to zoom in.

## Switching between vertical and horizontal viewing modes

Your phone's motion sensor can detect when you have turned the phone on its side, allowing you to switch to horizontal (also called "landscape") viewing mode, and when you have turned the phone upright again, allowing you to switch back to vertical (also called "portrait") viewing mode.

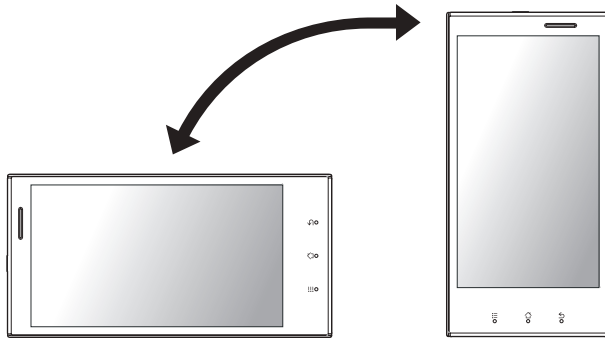

### Note

- Certain apps may not support both of these modes.
- You can turn this feature off if desired (see "Turning automatic screen rotation on and off" (page 20)).
- The phone may not be able to detect its orientation if it is lying flat or nearly flat on a surface.

## Home screen

The Home screen is your phone's main screen from which you can launch apps, such as the phone, camera, and web browser. You can customise the Home screen to suit your needs, and add, move, and remove items as desired.

You can also add widgets to the Home screen. Widgets are small programs that allow you to perform specific tasks quickly and easily, such as checking news or weather information, viewing new email messages, and configuring certain phone features, without leaving the Home screen. To add a widget to the Home screen, see "Adding an item in the app list to the Home screen" (page 13).

### Going to the Home screen

Tap  at any time.

### Browsing the Home screen

The Home screen can contain multiple pages of app icons and widgets. Flick left and right to view other pages.

You can also view a preview of all pages by tapping  → **[Home screens]**. From this preview screen, you can tap the desired page to display that page, tap and hold a page and drag it to change the order of the pages, add and delete pages, etc.



### Launching an app in the Home screen

Tap the app's icon.

### Moving an item in the Home screen

1. Tap and hold an item until the phone vibrates and the item is highlighted.
2. Drag the item to the new location.
  - You can move items to other pages by dragging them to the left or right edge of the screen.

### Using the app list

The app list gives you access to all the apps and widgets stored on your phone. To view the app list, tap  in the Home screen. While the app list is displayed, you can customise the order and layout of icons in the app list by tapping  and selecting an option.

### Adding an item in the app list to the Home screen

You can add apps and widgets found in the app list to the Home screen so that you can access them quickly.

1. Browse to the page of the Home screen where you want to add an app or widget.
2. Tap .
3. Browse to the page of the app list that contains the desired item.
4. Tap and hold the desired item.
  - The screen switches to the Home screen.
5. Drag the item and drop it in the Home screen.

### Using the Favourites tray

The Favourites tray is located in the bottom of the Home screen, regardless of which Home screen page you are viewing. It contains the app list icon  and other app icons. You can add, rearrange, and remove items in the Favourites tray by tapping and holding the desired item, and then dragging the item as necessary.

### Deleting an item from the Home screen

1. Tap and hold the item until the phone vibrates and the item is highlighted.
2. Drag the item and drop it on .

### Grouping apps into folders

Tap and hold an item, and then drop it on top of another item. A folder is created automatically and the two items are added to it.

### Renaming a folder

Tap the desired folder, tap the folder's name, and then edit the name.

### Changing the wallpaper on the Home screen

Tap  → **[Wallpaper]** and then browse to and select the desired item.

## Using apps

Apps expand the capabilities of your phone and allow you to customise it to suit your needs. Your phone comes preinstalled with a variety of apps, and you can download other apps from a variety of sources.

### Launching an app

Find the app in the Home screen or app list and then tap it.

### Closing an app

While using the app, tap .

#### **Note**

- App behaviours vary. When you tap , the current app may pause or continue to run in the background without quitting.

### Quitting an app

Normally there is no need to quit an app manually, but you can quit any running apps using the following procedure.

1. Tap **[Task viewer]** in the Home screen or app list.
2. Tap **×** in the upper-right corner of the app's icon.
  - To quit all apps, tap **[Terminate all apps]**.

### Opening an app's options menu

While using the app, tap the **☰** navigation button.

#### Note

- App behaviours vary. Some apps may not have an options menu, or the method for opening the options menu may be different.

### Switching between apps

Tap and hold **⇧** to display the list of recently used apps and then tap the desired app.

### Taking a screenshot

You can save what you see on the screen as an image file. Simply press and hold the **⏏** (volume down) and **⏻** (power) buttons at the same time. The screenshot is added to your picture album ("Viewing your pictures and videos" (page 53)).

## Status and notifications

### Status bar

The status bar is displayed at the top of your phone's screen when using most apps. It displays the time and provides icons and other indicators that let you know the status of your phone's battery, network signal strength, and certain features of your phone.



See "Status icons" (page 81) for a list of commonly used status icons and their meanings.

### Notifications panel

The notifications panel provides detailed information about incoming email messages, missed calls, calendar events, etc. You can open the notifications panel by tapping and holding the status bar and then sliding your finger down. To close the notifications panel, tap and hold the bottom of the screen and then slide your finger up. While the notifications panel is open, you can tap a notification and open the corresponding app, or flick a notification left or right to delete it from the panel.

See "Notification icons" (page 80) for a list of commonly used notification icons and their meanings.

### Control panel

The control panel is displayed in the notifications panel and allows you to change settings for certain features quickly without switching to another screen. Simply tap the feature icons that are displayed in the control panel to toggle through the available settings.

| 1 | 2 | 3 | 4 | 5 | 6 | 7 | 8 |
|---|---|---|---|---|---|---|---|
|   |   |   |   |   |   |   |   |

- ❶ eco mode (auto, on, off)
- ❷ Ringer mode (ringer on, silent, vibrate)
- ❸ Screen brightness (auto, dim, half, full)
- ❹ Wi-Fi (on, off)
- ❺ *Bluetooth* (on, off)
- ❻ GPS (on, off)
- ❼ Auto-sync for email, contacts, etc. (on, off)
- ❽ Auto screen rotate (on, off)

## Typing on your phone

Your phone's keyboard is displayed automatically when you tap a text entry field or when you are prompted to enter information.

### FlexT9 keyboard overview

When the FlexT9 keyboard is displayed, you can select a different keyboard and change keyboard settings by tapping and holding the lower-left key (❷ in the illustration).

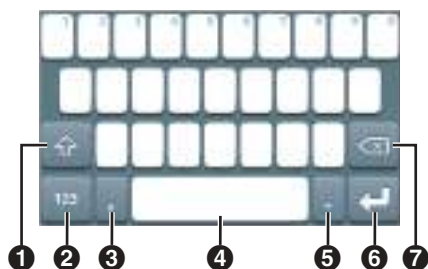

- ❶ The shift key. Tap to change the character case; double-tap to turn on the caps lock.
- ❷ Tap to switch between letters, numbers, and symbols. Tap and hold to select a different keyboard or change keyboard settings.
- ❸ Tap to enter a comma.
- ❹ The space bar. Tap to enter a space; tap and hold to select a different input language.
- ❺ Tap to enter a period.
- ❻ Tap to enter a line break or confirm the text you have input.
- ❼ Tap to delete the character before the cursor; tap and hold to delete characters quickly.

### Note

- You can tap and hold certain keys to display a list of other characters available.
- You can also enter text by sliding your finger from one key to another.
- Turn the phone on its side to display the keyboard in horizontal viewing mode.
- Certain keys and features explained here may not be available depending on the app, the input language, input settings, or the type of information being entered (e.g., email addresses, passwords, etc.).

### Android keyboard overview

When the Android keyboard is displayed, you can select a different keyboard by tapping and holding the space bar (4 in the illustration).

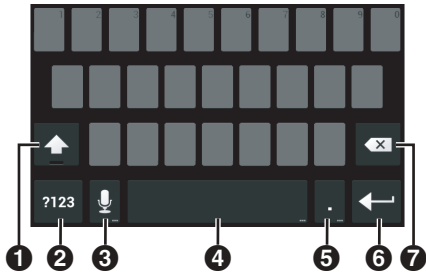

- 1 The shift key. Tap to change the character case; double-tap to turn on the caps lock.
- 2 Tap to switch between letters, numbers, and symbols.
- 3 Tap to enable voice input (when the microphone is enabled); tap and hold to change keyboard settings.
- 4 The space bar. Tap to enter a space; tap and hold to select a different keyboard.
- 5 Tap to enter a period.
- 6 Tap to enter a line break or confirm the text you have input.
- 7 Tap to delete the character before the cursor; tap and hold to delete characters quickly.

#### Note

- When ... is displayed on a key, you can tap and hold the key to display a list of other available characters or options.
- Turn the phone on its side to display the keyboard in horizontal viewing mode.
- Certain keys and features explained here may not be available depending on the app, the input language, input settings, or the type of information being entered (e.g., email addresses, passwords, etc.).

### Editing text

**To move the cursor:** Tap the area of text where you want to insert or edit text. The cursor will appear. Drag the cursor to the desired area.

**To insert or edit text:** Place the cursor at the desired point, and then insert or edit text as desired.

**To select text:** Tap and hold or double-tap the area of text you want to select. The text selection tabs will appear. Drag the tabs to select the desired start and end point. You can also select all text by tapping





**To cut or copy text:** Select the desired text and then tap  (to cut) or  (to copy).

**To paste text:** Place the cursor at the desired point, and then tap the cursor. Tap the **[PASTE]** option when it is displayed. You can also select an area of text to be replaced by the pasted text; select the text to be replaced and then tap .

### Selecting the input languages when using the Android keyboard

You can select the input languages available when entering text. If more than one input language is selected, you can change the current input language when typing by tapping and holding the space bar.

1. From the Home screen, tap  → **[Settings]**.
2. Tap **[Language & input]**.
3. Tap  next to **[Android keyboard]**.
4. Tap **[Input languages]**.
5. Select the desired languages.
  - The Android keyboard uses the system language by default. To select specific languages, first turn off the **[Use system language]** checkbox.





### Using voice recognition when using the Android keyboard

When voice recognition is enabled, you can enter words by speaking to your phone. This feature requires an active Internet connection.

1. Tap .
2. Speak the words or a sentence.
  - Your phone automatically recognises the words and enters the text you spoke.

### Enabling voice recognition when using the Android keyboard

1. From the Home screen, tap  → **[Settings]**.
2. Tap **[Language & input]**.
3. Turn on the **[Google voice typing]** checkbox.
4. Tap  next to **[Android keyboard]**.
5. Tap **[Voice input key]** and then select an option that displays the voice input option on the keyboard.

## Account settings

You can enter your account information for services such as Google, Microsoft Exchange ActiveSync, Facebook, and Twitter, so that you can use your phone to access these services. For some services, you will need to access the service's web site and create an account before you can register the account information in your phone.

You can register multiple accounts to your phone if necessary.

### Registering your Google account

You can register your Google account information in your phone and access Gmail, your Google contacts, calendar, and other Google account services.

1. From the Home screen, tap  → **[Settings]**.
2. Tap **[Accounts & sync]** → **[ADD ACCOUNT]** → **[Google]**.
3. Follow the on-screen instructions.

#### **Note**

- If you forget your Google account user name or password, you can get help at the Google web site by using the "can't access account" link on the Google account login screen.

### Registering your email account

You can register your email account information and use the **[Email]** app to send and receive email messages. The **[Email]** app supports POP3, IMAP, and Microsoft Exchange ActiveSync accounts.

#### **Note**

- If you have a Gmail account, we recommend registering your Google account to the phone (as opposed to using the following procedure). If you use the following procedure to register your Gmail account, you will not be able to take advantage of certain Gmail features when using the **[Email]** app.
- If you have a corporate email account that is provided by your institution's Microsoft Exchange ActiveSync server, we recommend registering your Microsoft Exchange ActiveSync account to the phone (as opposed to using the following procedure). If you use the following procedure to register your corporate email account, you will not be able to take advantage of certain Microsoft Exchange ActiveSync features, such as contacts and calendar synchronisation.

1. From the Home screen, tap  → **[Settings]**.
2. Tap **[Accounts & sync]** → **[ADD ACCOUNT]** → **[Email]**.

3. Follow the on-screen instructions.
  - If the account cannot be set up using this procedure, you may need to set up the account manually. In this case consult your email service provider for details about settings.

### Registering your Microsoft Exchange ActiveSync account

If your institution supports Microsoft Exchange ActiveSync, you can register your account to the phone and access your corporate email, contacts, calendar, etc.

1. From the Home screen, tap  → **[Settings]**.
2. Tap **[Accounts & sync]** → **[ADD ACCOUNT]** → **[Corporate]**.
3. Follow the on-screen instructions.
  - If the account cannot be set up using this procedure, you may need to configure the account manually. Contact your corporate network administrator for more information.



### Setting account synchronisation settings

You can select which account services are synchronised with your phone.

1. From the Home screen, tap  → **[Settings]**.
2. Tap **[Accounts & sync]**.
3. Turn on the **[Accounts & sync]** switch.
  - Turn off the switch to disable synchronisation for all accounts.
4. Select the desired account.
5. Turn on the checkbox for each item you would like to synchronise.

### Removing an account

If you remove an account, corresponding data will be deleted from the phone. Online data will not be affected.

1. From the Home screen, tap  → **[Settings]**.
2. Tap **[Accounts & sync]**.
3. Select the desired account.
4. Tap  → **[Remove account]** → **[Remove account]**.

## Customising your phone

---

You can customise your phone by changing the date and time, ringtone, vibrating mode, screen settings, display language, etc. Some commonly used settings are explained below.

### General settings

#### Setting the date and time

Your phone can set its date and time setting automatically using network-provided information, or you can set the date and time manually if you prefer.

1. From the Home screen, tap  → **[Settings]**.
2. Tap **[Date & time]**.
3. To set the date and time automatically:
  - Turn on the **[Automatic date & time]** checkbox. No other settings are required.
  - To set the date and time manually:
    - Turn off the **[Automatic date & time]** checkbox and then continue to the next step.
4. Tap **[Set date]**.
5. Set the date and then tap **[Set]**.
6. Tap **[Set time]**.
7. Set the time and then tap **[Set]**.

### Setting the time zone

You can set the time zone automatically using network-provided information, or you can select a specific time zone if you prefer.



1. From the Home screen, tap  → **[Settings]**.
2. Tap **[Date & time]**.
3. To set the time zone automatically:  
→ Turn on the **[Automatic time zone]** checkbox. No other settings are required.  
To set the time zone manually:  
→ Turn off the **[Automatic time zone]** checkbox and then continue to the next step.
4. Tap **[Select time zone]**.
5. Select a city in your time zone.

### Switching between 12-hour and 24-hour format time

1. From the Home screen, tap  → **[Settings]**.
2. Tap **[Date & time]**.
3. Turn the **[Use 24-hour format]** checkbox on or off.

### Turning aeroplane mode on and off

Aeroplane mode turns off all wireless features to prevent interference with aircraft equipment, and conserves battery power. You cannot make or receive calls while aeroplane mode is enable, but you can listen to music, play games, read downloaded email messages, compose email messages, and use other features of your phone as long as those features do not require a network connection.

1. Press and hold  on the side of the phone.
2. Tap **[Aeroplane mode]** to turn aeroplane mode on or off.
  -  is displayed in the status bar when aeroplane mode is turned on.

## Screen settings

### Changing the language of the phone

1. From the Home screen, tap  → **[Settings]**.
2. Tap **[Language & input]** → **[Language]**.
3. Select the desired language and then tap **[Yes]**.

### Adjusting the screen brightness manually

1. From the Home screen, tap  → **[Settings]**.
2. Tap **[Display]** → **[Brightness]**.
3. Turn off the **[Automatic brightness]** checkbox and then adjust brightness.
4. Tap **[OK]**.

#### **Note**

- Increasing the brightness setting decreases your phone's battery performance.

### Setting the screen timeout

The screen timeout setting determines how much time passes before the screen automatically turns off to save power.

1. From the Home screen, tap  → **[Settings]**.
2. Tap **[Display]** → **[Sleep]**.
3. Select the desired setting.

### Note

- You can turn off the screen at any time by pressing .

### Turning automatic screen rotation on and off

1. From the Home screen, tap  → **[Settings]**.
2. Tap **[Display]**.
3. Turn the **[Auto-rotate screen]** checkbox on or off.

### Setting the screen to stay on while the phone is charging

1. From the Home screen, tap  → **[Settings]**.
2. Tap **[Developer options]**.
3. Read the message and then tap **[OK]**.
4. Turn on the **[Stay awake]** checkbox.

## Sound settings

### Changing the ringtone for phone calls

1. From the Home screen, tap  → **[Settings]**.
2. Tap **[Sound]** → **[Phone ringtone]**.
3. Select the desired setting and then tap **[OK]**.

### Changing the ringtone for notifications

1. From the Home screen, tap  → **[Settings]**.
2. Tap **[Sound]** → **[Default notification]**.
3. Select the desired setting and then tap **[OK]**.

### Adjusting the volume

1. From the Home screen, tap  → **[Settings]**.
2. Tap **[Sound]** → **[Volumes]**.
3. Adjust the volume for each item and then tap **[OK]**.

### Turning silent mode on and off

1. Press and hold  on the side of the phone.
2. Select the desired setting.

 Turns the ringer off

 Turns the vibrate feature on

 Turns the ringer on

### Turning dialling touch tones on and off

1. From the Home screen, tap  → **[Settings]**.
2. Tap **[Sound]**.
3. Turn the **[Dial-pad touch tones]** checkbox on or off.

### Setting the phone to vibrate and ring

1. From the Home screen, tap  → **[Settings]**.
2. Tap **[Sound]**.
3. Turn on the **[Vibrate and ring]** checkbox.

### Setting the phone to vibrate when operated

1. From the Home screen, tap  → **[Settings]**.
2. Tap **[Sound]**.
3. Turn on the **[Vibrate on touch]** checkbox.

## eco mode

eco mode is a suite of features that help you save battery power. When the remaining battery power drops below the preset level, the phone can switch to eco mode and change certain phone features and settings so that your phone consumes less battery power.

### Setting the eco mode operation mode

1. Open the notifications panel by tapping and holding the status bar and then sliding your finger down.
2. Tap **eco** at the top of the screen.
3. Under **[eco mode status]**, select the desired operation mode.
  - **[ON]**: The phone always runs in eco mode, regardless of the current battery level. Features will be limited to save battery power according to the eco mode settings.
  - **[OFF]**: The phone never switches to eco mode.
  - **[Auto eco]**: When the remaining battery power drops below the preset level, features will be limited to save battery power according to the eco mode settings.

#### Note

- After opening the notifications panel, you can also set the eco mode operation mode quickly by tapping **[eco mode]** in the control panel (“Control panel” (page 14)). A different operation mode is selected each time you tap **eco**.
- If your phone is operating in eco mode and you try to change phone settings that are also controlled by eco mode, you will be asked whether or not you want to disable eco mode. If you disable eco mode, **[eco mode status]** will be automatically set to **[OFF]**.

### Changing the eco mode settings

eco mode settings determine how your phone saves power. You can configure eco mode to limit various features, including:

- Screen brightness
- Automatic screen rotation
- Wi-Fi, GPS, and *Bluetooth* features
- Data synchronisation features

#### Note

- If the phone is configured to always keep the Wi-Fi connection active using the **[Keep Wi-Fi on during sleep]** (“Changing the Wi-Fi sleep policy” (page 26)), that setting overrides any limits on Wi-Fi connections that you have set using eco mode.
1. Open the notifications panel by tapping and holding the status bar and then sliding your finger down.
  2. Tap **eco** at the top of the screen.
  3. Tap **[eco mode setting]**.
  4. Change the settings as desired.
    - **[Auto eco mode setting]**: Set the battery level at which the phone switches to eco mode.
    - **[eco mode setting]**: Set each item as desired.
  5. Tap **[OK]**.

## Storage

Your phone can store apps and data in two different storage areas.

| Storage area     | Description  | Main contents   |
|------------------|--|---|
| Internal storage | An area of the phone's internal memory that is not visible when the phone is connected to a computer. If you reset the phone, the contents of the internal storage are deleted.  | <ul style="list-style-type: none"><li>• Apps</li><li>• Settings</li><li>• SMS and MMS messages</li><li>• Contacts</li></ul>   |
| USB storage      | An area of the phone's internal memory that is visible when the phone is connected to a computer, allowing you to manually copy data to and from your phone and the computer. If you reset the phone, you have the option to retain or delete the contents of the USB storage. | <ul style="list-style-type: none"><li>• Pictures and videos captured with the phone's <b>[Camera]</b> app</li><li>• Music and podcasts</li><li>• Customised ringtones</li><li>• Data you have copied to the phone from a computer (page 69)</li><li>• Data you have backed up with the <b>[USB storage backup]</b> feature (page 72)</li><li>• Downloaded data</li><li>• Apps that you have moved from the internal storage</li></ul> |

### Note

- Some apps may refer to the phone's USB storage as "SD card". In this case selecting "SD card" will select the USB storage.

### Confirming available storage capacity

1. From the Home screen, tap  → **[Settings]**.
2. Tap **[Storage]**.

## Stereo headset

You can use the included stereo headset to answer and end calls, talk on the phone, listen to music and videos, etc.

- To answer an incoming call, press the headset button.
- To reject an incoming call, or to end the current call, press and hold the headset button for about a second.
- To stop and start music playback while listening to music, press the headset button.

### Connecting the stereo headset

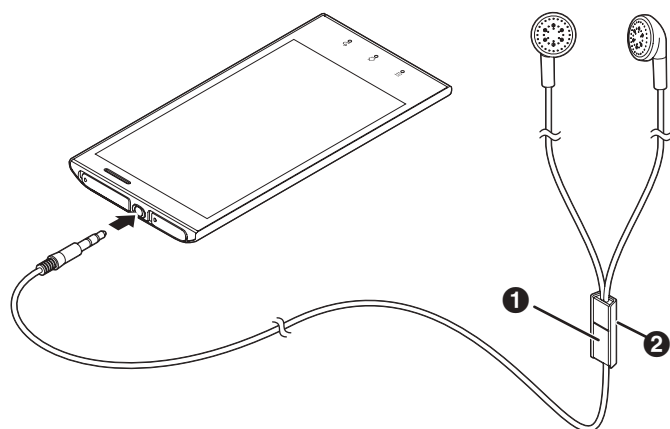

- ❶ Headset button
- ❷ Microphone

#### **Note**

- Make sure you insert the headset plug completely into the headset jack.

# Connecting to networks



## Connecting to mobile networks

In order to use a mobile network to send text and multimedia messages and to connect to the Internet, your phone must be configured to connect to a mobile network. For most mobile networks and mobile network operators, your phone is configured at the time of purchase and you do not need to configure your phone manually. For information about configuring your phone manually, contact your mobile network operator.

### Viewing the current Access Point Name (APN)

1. From the Home screen, tap  → **[Settings]**.
2. Tap **[More...]** → **[Mobile networks]** → **[Access Point Names]**.
  - If multiple connections are available, the current connection will be indicated.

### Configuring Internet settings manually

1. From the Home screen, tap  → **[Settings]**.
2. Tap **[More...]** → **[Mobile networks]** → **[Access Point Names]** →  → **[New APN]**.
3. Tap **[Name]**, enter the desired name for the new settings, and then tap **[OK]**.
4. Tap **[APN]**, enter the access point name, and then tap **[OK]**.
5. Select other items and enter the information as required by your mobile network operator.
6. Tap  → **[Save]**.

### Selecting a specific network manually

You can select a specific network to connect to. This may be useful when travelling abroad and you want to use a particular network. Note that if you select a specific network, your phone will not connect to other networks even if you move out of range of the network you selected manually.

1. From the Home screen, tap  → **[Settings]**.
2. Tap **[More...]** → **[Mobile networks]** → **[Network operators]**.
3. Select a network.

### Selecting a network automatically

1. From the Home screen, tap  → **[Settings]**.
2. Tap **[More...]** → **[Mobile networks]** → **[Network operators]** → **[Select automatically]**.

### Disabling mobile network data connections

You can disable mobile network data connections. This can be useful if you want to avoid unwanted downloading of data or synchronising of data. Wi-Fi network connections will remain available.

1. From the Home screen, tap  → **[Settings]**.
2. Tap **[More...]** → **[Mobile networks]**.
3. Turn off the **[Data enabled]** checkbox.

### Configuring mobile network data usage limits

You can confirm and limit data usage.

#### **Note**

- Using this feature does not guarantee reduced mobile network usage or reduced data transmission charges.
1. From the Home screen, tap  → **[Settings]**.
  2. Tap **[Data usage]**.



3. Turn on the **[Mobile data]** switch.
4. Turn on the **[Set mobile data limit]** checkbox and then tap **[OK]**.
5. Tap the item next to **[Data usage cycle]** and change the cycle if necessary.
6. Drag the right edge of the orange bar up or down to set the threshold for displaying the data usage warning.
7. Drag the right edge of the red bar up or down to set the data usage limit.

### Enabling data roaming

When data roaming is enabled, you may be able to use another mobile network operator's network for data connections. This can be useful when you are outside of the range of your operator's network. Note that data transmission charges may apply, and some apps on your phone may use data connections without notifying you. Contact the mobile network operator for more information.

1. From the Home screen, tap  → **[Settings]**.
2. Tap **[More...]** → **[Mobile networks]**.
3. Turn on the **[Data roaming]** checkbox and then tap **[OK]**.

## Connecting to Wi-Fi networks

If your phone is within range of a Wi-Fi access point, such as a wireless router, you can access the Internet wirelessly using your phone's Wi-Fi features. When your phone is connected to a Wi-Fi access point, your phone uses the Wi-Fi connection to access the Internet (as opposed to using the mobile network). If your phone disconnects from a Wi-Fi network, it will automatically connect to the mobile network.



### Turning on Wi-Fi

1. From the Home screen, tap  → **[Settings]**.
2. Turn on the **[Wi-Fi]** switch.

#### Note

- When Wi-Fi is turned on, the phone can continue to use its mobile data connection, but the phone will use the Wi-Fi connection when it is available.
- If you turn Wi-Fi off, the phone will automatically switch to the mobile data connection (if enabled). In this case, note that data transmission charges may apply.

### Connecting to a Wi-Fi network

1. From the Home screen, tap  → **[Settings]**.
2. Tap **[Wi-Fi]**.
3. Select a Wi-Fi network.
  - If the desired Wi-Fi network is not displayed, you may need to enter the network name (SSID). See "Adding a Wi-Fi network manually" (page 26) for more information.
4. Enter the password if you are connecting to a secure Wi-Fi network.
5. Tap **[Connect]**.
  -  is displayed in the status bar when the phone is connected to a Wi-Fi network and indicates the approximate signal strength.

#### Note

- After you connect to a Wi-Fi network, your phone will automatically connect to that network the next time it is within range.
- After you move out of range of a Wi-Fi network, it may take some time for the phone to re-connect automatically once the phone is within range of that Wi-Fi network again.
- Some Wi-Fi networks require you to access a web page or enter a user name and password in order to access the network. Consult the network administrator for more information.

### Adding a Wi-Fi network manually

Some Wi-Fi networks do not broadcast their availability. In this case you need to enter the name of the network (also called the “network SSID”) as well as the network’s password. Consult the network system administrator for more information.

1. From the Home screen, tap  → **[Settings]**.
2. Tap **[Wi-Fi]** → **[ADD NETWORK]**.
3. Enter the network SSID.
4. Select the network’s security type and enter its password, if required.
5. Tap **[Save]**.

### Deleting a Wi-Fi network’s settings

You can delete the access information for a Wi-Fi network. Once you delete a Wi-Fi network’s settings from the phone, you will need to connect to the network manually (and enter the password if required) if you want to connect to the network again.



1. From the Home screen, tap  → **[Settings]**.
2. Tap **[Wi-Fi]**.
3. Select the Wi-Fi network and then tap **[Forget]**.

### Viewing information about the Wi-Fi network

1. From the Home screen, tap  → **[Settings]**.
2. Tap **[Wi-Fi]**.
3. Select the Wi-Fi network which you are currently connected to.



### Enabling Wi-Fi network notification

Your phone can notify when a Wi-Fi network is available.

1. From the Home screen, tap  → **[Settings]**.
2. Tap **[Wi-Fi]** → **[ADVANCED]**.
  - Depending on the display language, you may need to tap  before you can tap **[ADVANCED]**.
3. Turn on the **[Network notification]** checkbox.

### Changing the Wi-Fi sleep policy

You can select when your phone suspends its Wi-Fi connection.



1. From the Home screen, tap  → **[Settings]**.
2. Tap **[Wi-Fi]** → **[ADVANCED]** → **[Keep Wi-Fi on during sleep]**.
  - Depending on the display language, you may need to tap  before you can tap **[ADVANCED]**.
3. Select the desired setting.
  - If the phone is configured to always keep the Wi-Fi connection active, this setting overrides any limits on Wi-Fi connections that you have set using eco mode.

### Using a static IP address

1. From the Home screen, tap  → **[Settings]**.
2. Tap **[Wi-Fi]**.
3. Tap and hold the name of the desired network and then tap **[Modify network]**.
4. Turn on the **[Show advanced options]** checkbox.
5. Tap the setting displayed under **[IP settings]** and then tap **[Static]**.
6. Select each item and enter the necessary information.
7. Tap **[Save]**.

## Using Wi-Fi Direct

Wi-Fi Direct allows you to use your phone to create peer-to-peer connections with other devices that are compatible with Wi-Fi Direct.

1. From the Home screen, tap  → **[Settings]**.
2. Tap **[More...]**.
3. Turn on the **[Wi-Fi direct]** checkbox and then tap **[OK]**.
  - When this feature is enabled, other Wi-Fi features and connections are disabled. The phone will not be able to connect to the Internet via Wi-Fi while this feature is turned on.
  -  is displayed in the status bar when Wi-Fi Direct is enabled.
4. Tap **[Wi-Fi Direct settings]**.
  - A list of nearby devices that are compatible with Wi-Fi Direct is displayed.
5. Select the desired device and then tap **[Connect]**.
  - The other device will display a connection request message. Using the other device, follow the on-screen instructions and allow the connection.
  - To disconnect, repeat this procedure and tap **[Forget]**.



## Creating a Wi-Fi hotspot

Your phone can function as a portable Wi-Fi hotspot, allowing you to share your phone's mobile network connection with up to five devices.

### Note

- Additional charges may be incurred when using this feature. Contact your mobile network operator for more information.

### Configuring the phone as a Wi-Fi hotspot

1. From the Home screen, tap  → **[Settings]**.
2. Tap **[More...]** → **[Tethering & portable hotspot]** → **[Configure Wi-Fi hotspot]**.
3. Configure the SSID (i.e., network name), security method, and password, and then tap **[Save]**.
  - This information must be entered on other devices before they can connect to your phone and use its mobile network connection.
  - If you select open-type security, other devices can access your phone's mobile network connection without entering a password. To avoid unforeseen data transmission charges, we recommend you select a security method that requires a password.
  - If you select open-type security, only one device can access your phone's mobile network at a time.
4. Turn on the **[Portable Wi-Fi hotspot]** checkbox and then tap **[OK]**.
  - When this feature is enabled, other Wi-Fi features and connections are disabled. The phone will not be able to connect to the Internet via Wi-Fi while this feature is turned on.
  - Turn off the **[Portable Wi-Fi hotspot]** checkbox when you are finished using your phone as a Wi-Fi hotspot.
  -  is displayed in the status bar when Wi-Fi hotspot is enabled.
  -  is displayed in the status bar when Wi-Fi hotspot and USB tethering (see "Using USB tethering" (page 69)) are both enabled.

### Note

- This feature is disabled when the phone's *Bluetooth* feature is enabled.

## Connecting to VPNs

---

If your company or organisation uses a Virtual Private Network (VPN), you can use your phone to connect to the VPN. For information about configuring your phone to connect to a VPN, consult your network administrator.



### Note

- In order to use VPN features, you must first configure the screen lock feature to use a PIN, password, or other secure unlock method. See “Locking the screen” (page 74) for details.

### Adding a VPN

1. From the Home screen, tap  → **[Settings]**.
2. Tap **[More...]** → **[VPN]** → **[Add VPN network]**.
3. Select each item and enter the necessary information.
4. Tap **[Save]**.

### Connecting to a VPN

1. From the Home screen, tap  → **[Settings]**.
2. Tap **[More...]** → **[VPN]**.
3. Select your VPN.
4. Enter the information as needed.
5. Tap **[Connect]**.
  - The phone must be connected to a Wi-Fi network and be able to access the Internet in order to connect to a VPN.
  -  is displayed in the status bar when the phone is connected to a VPN.

### Disconnecting from a VPN

1. Open the notifications panel by tapping and holding the status bar and then sliding your finger down.
2. Tap the VPN connection notification.
3. Tap **[Disconnect]**.



# Phone

You can use the **[Phone]** app to make and receive calls, as well as use services supported by your mobile network operator, such as voicemail and call forwarding. For information about available services, contact your mobile network operator.

## Making calls

### Making an emergency call



Your phone supports international emergency numbers, such as 112 and 911.

1. Tap **[Phone]** in the Home screen or app list.
2. Enter the emergency number.
  - To delete a number, tap .
3. Tap .
4. Tap  to end the call.

#### Note

- If the screen lock feature has been configured to use a PIN, password, or other secure method (see “Configuring the screen lock” (page 74)), you can make emergency calls from the lock screen by tapping **[Emergency call]**. In this case there is no need to unlock the screen.
- You can make emergency calls even if there is no SIM card inserted, as long as the phone is in range of a network and the region you are in allows emergency calling with no SIM card inserted.



### Dialling manually

1. Tap **[Phone]** in the Home screen or app list.
2. Enter the phone number.
  - To delete a number, tap .
3. Tap .
4. Tap  to end the call.

### Adding a number to your contacts while dialling

1. After dialling a number manually, tap  → **[Add to contacts]**.
2. To add the number to an existing contact:  
→ Tap the desired contact.  
To add the number to a new contact:  
→ Tap **[CREATE NEW CONTACT]**.
3. Enter or edit the information as needed and tap **[OK]** or **[DONE]**.

### Making an international call

1. Tap **[Phone]** in the Home screen or app list.
2. Tap and hold **[0]** until the international prefix “+” is displayed.
3. Enter the country code or region code, followed by the area code (without the first 0) and the phone number.
  - When calling certain countries or regions, such as Italy, the first 0 of the area code must be entered.
4. Tap .
5. Tap  to end the call.



## Using other features during a call

---



### Adjusting the earpiece or speaker volume

Press ▲ or ▼ repeatedly during a call.

### Muting the microphone

Tap  during a call to mute your phone's microphone so that the other party cannot hear you. Tap  again to turn the mute off.

### Using the speakerphone

Tap  to turn on the speakerphone during a call. Tap  again to switch back to the earpiece.

### Activating the screen while talking

Your phone's proximity sensor detects when you raise the phone to your ear and automatically turns off the screen. This not only saves battery power, but also prevents you from inadvertently operating the screen while talking.

Note that if you turn off the screen while on a call, the call will continue.

### Entering numbers during a call

Tap  during a call if you need to enter numbers, such as when navigating a call centre's voice guided menu system.

### Making or answering another call

See "Conference calls" (page 32).



### Using a headset

See "Stereo headset" (page 22).

## Answering calls

---



### Answering a call

1. When a call is being received, tap  and drag it to .
2. Tap  to end the call.

### Rejecting a call

When a call is being received, tap  and drag it to .

### Sending a message to a caller

You can send a message to a caller without answering the call. When a call is being received, tap  and drag it to , and then select the desired message.

You can customise the messages while using the **[Phone]** app by tapping  → **[Settings]** → **[Quick responses]**.



### Turning the ringer off temporarily

Press ▲ or ▼ when a call is being received to turn the ringer off temporarily.

### Turning silent mode on and off

1. Press and hold  on the side of the phone.



2. Select the desired setting.

-  Turns the ringer off
-  Turns the vibrate feature on
-  Turns the ringer on

## Call log

### Viewing the call log

You can view your call log while using the **[Phone]** app by tapping . The following icons are used in the call log to indicate different types of calls.

-  Missed calls
-  Answered calls
-  Outgoing calls

### Viewing your missed calls

Open the notifications panel and then tap **[Missed call]**.



### Making a call from the call log

Tap  next to the phone number or person you want to call.

### Adding information from the call log to your contacts

1. Tap **[Phone]** in the Home screen or app list.
2. Tap .
3. Select the desired phone number and then tap **[Add to contacts]**.
4. To add the number to an existing contact:  
→ Tap the desired contact.  
To add the number to a new contact:  
→ Tap **[CREATE NEW CONTACT]**.
5. Enter or edit the information as needed and tap **[OK]** or **[DONE]**.

### Clearing the call log

1. Tap **[Phone]** in the Home screen or app list.
2. Tap  →  → **[Clear call log]** → **[OK]**.

## Voicemail

If your phone has voicemail service, you can have your calls forwarded to voicemail.

### Listening to voicemail

When a voicemail is received,  is displayed on the left side of the status bar. To access your mobile network operator's voicemail service, you can open the notifications panel and tap the new voicemail notification, or follow the instructions below.

1. Tap **[Phone]** in the Home screen or app list.
2. Tap and hold **[1]**.

### Setting the voicemail access number

For the correct setting, contact your mobile network operator.

1. From the Home screen, tap  → **[Settings]**.
2. Tap **[Call settings]** → **[Voicemail settings]** → **[Voicemail number]**.
3. Enter your mobile network operator's voicemail access number and then tap **[OK]**.

## Call forwarding

---

If your phone has call forwarding service, you can forward your calls to another phone number.

### Turning call forwarding on

1. From the Home screen, tap  → **[Settings]**.
2. Tap **[Call settings]** → **[Call forwarding]**.
3. Select the desired setting.
4. Enter the forwarding number and then tap **[Enable]**.

### Turning call forwarding off

1. From the Home screen, tap  → **[Settings]**.
2. Tap **[Call settings]** → **[Call forwarding]**.
3. Tap the current setting and then tap **[Disable]**.

## Call waiting





---

If your phone has call waiting service, you can receive a second call while talking on the phone. While talking, you will hear a tone that indicates a second call is being received. When you receive a second call, you can choose to reject it or answer it.



### Turning call waiting on

1. From the Home screen, tap  → **[Settings]**.
2. Tap **[Call settings]** → **[Additional settings]**.
3. Turn on the **[Call waiting]** checkbox.

### Answering another call while talking on the phone

1. When you hear the call waiting tone, tap  and drag it to .
2. To switch between calls:  
→ Tap .
- To join the calls and have a conversation with all parties:  
→ Tap .
- To end the current call:  
→ Tap .

### Rejecting a call received while talking on the phone

When you hear the call waiting tone, tap  and drag it to .



## Conference calls

---



If your phone has conference calling service, you can talk on the phone with multiple parties at the same time and put the other party on hold.



### Making a second call

1. While on a call, tap .
2. Enter the other party's phone number and then tap 
  - The first call is put on hold.

### Handling multiple calls

1. While on a call, make or answer a second call.
2. To switch between calls:
  - Tap .
  - To join the calls and have a conversation with all parties:
    - Tap .
  - To end the current call:
    - Tap .

## Sending your caller information (Caller ID)

### Changing the Caller ID setting

You can choose to show or hide your phone number to the other party when you make calls.

1. From the Home screen, tap  → **[Settings]**.
2. Tap **[Call settings]** → **[Additional settings]** → **[Caller ID]**.
3. Select the desired setting.

## Fixed dialling

You can use a Fixed Dialling Number (FDN) list to restrict outgoing calls. When this feature is turned on, your phone can only make calls to numbers that are added to the list.

### **Note**

- You must enter the PIN 2 code assigned to you by your mobile network operator in order to use this feature.

### Turning fixed dialling on and off

1. From the Home screen, tap  → **[Settings]**.
2. Tap **[Call settings]** → **[Fixed Dialling Numbers]** → **[Enable FDN]**.
3. Enter your PIN 2 code and then tap **[OK]**.

### Editing the list of fixed dialling numbers

1. From the Home screen, tap  → **[Settings]**.
2. Tap **[Call settings]** → **[Fixed Dialling Numbers]** → **[FDN list]**.

# People

## Adding contacts to your phone

You can use the **[People]** app to store all your contact information. Entries (also called “contacts”) contain information about your friends, family, and colleagues, such as their addresses, phone numbers, and email addresses. There are several ways you can get contact information into your phone.

- Using your phone to add contacts manually
- Synchronising your phone with contacts you’ve added to an online service, such as Google
- Importing contacts that you’ve stored on your phone’s SIM card or in the USB storage
- Using your phone’s *Bluetooth* wireless technology feature to download contacts from another device
- Importing contacts that you’ve received as a vCard file attached to an email message

### Synchronising your contacts with an existing online synchronisation service account

See “Setting account synchronisation settings” (page 18).

### Importing contacts from the phone’s SIM card or USB storage

1. Tap **[People]** in the Home screen or app list.
2. Tap  → **[Import/export]**.
3. Select the desired options and follow the on-screen instructions to import the desired contacts.
  - If you have more than one account registered to the phone, you will be prompted to select the account that the imported contacts will be added to.

### Importing contacts using *Bluetooth* wireless technology

In order to import contacts using *Bluetooth* wireless technology, make sure your phone’s *Bluetooth* feature is turned on and is set to discoverable mode (see “Bluetooth wireless technology” (page 66)).





1. Send the data to your phone from the sending device.
  - Refer to the operating instructions included with the other device for details.
2. Open the phone’s notifications panel and then tap **[Bluetooth share: Incoming file]** → **[Accept]**.
3. Open the phone’s notifications panel again and then tap **[Bluetooth share: Received files]**.
4. Tap the file received by Bluetooth to import the contacts.
  - If you have more than one account registered to the phone, you will be prompted to select the account that the imported contacts will be added to.

### Importing contacts from email

You can import contacts you’ve received as a vCard file attached to an email message.

1. Open the message containing the vCard file.
2. Tap **[VIEW]** under the desired attachment.
  - If you have more than one account registered to the phone, you will be prompted to select the account that the imported contacts will be added to.

### Adding a contact manually

1. Tap **[People]** in the Home screen or app list.
2. Tap , and, if prompted, select the account that the contact will be added to.
3. Enter the information as needed.
  - To add an image, tap the image icon.
  - To undo the changes you have made, tap  → **[Discard]** → **[OK]**. Note that if you tap , the changes will be saved.
  - To add the new contact information to an existing contact, tap  → **[Join]**.

4. Tap **[DONE]**.

### Adding yourself to your contacts

1. Tap **[People]** in the Home screen or app list.
2. Tap **[Set up my profile]**.
  - If **[Set up my profile]** is not displayed, tap the content displayed under **[ME]**, and then tap  → **[Edit]**.
3. Enter the information as needed.
4. Tap **[DONE]**.

#### Note

- You can share your contact information by sending it in an email message, sending it to another device via *Bluetooth* wireless technology, etc. See “Sharing a contact” (page 36).

## Managing your contacts

### Searching for a contact

1. Tap **[People]** in the Home screen or app list.
2. Tap  and then enter the search text.
  - You can also scroll using the slider on the right side of the screen to search for a contact by first letter.

### Calling, texting, or emailing a contact

1. Tap **[People]** in the Home screen or app list.
2. Tap the contact and then select the desired method of communication.

### Changing display options

1. Tap **[People]** in the Home screen or app list.
2. Tap  → **[Settings]**.
3. Select the desired setting and follow the on-screen instructions.

### Editing a contact



1. Tap **[People]** in the Home screen or app list.
2. Select the desired contact and then tap  → **[Edit]**.
3. Edit the information as needed.
4. Tap **[DONE]**.

### Deleting a contact

1. Tap **[People]** in the Home screen or app list.
2. Select the desired contact and then tap  → **[Delete]** → **[OK]**.

### Adding a contact to your list of favourites

You can add contacts to your list of favourites.



1. Tap **[People]** in the Home screen or app list.
2. Select the desired contact and then tap .
  - Tap  to remove the contact from your list of favourites.

### Viewing favourites and frequently used contacts



1. Tap **[People]** in the Home screen or app list.
2. Tap the  tab.

### Creating a group

You can create groups of contacts for simplified management.

1. Tap **[People]** in the Home screen or app list.
2. Tap the  tab.
3. Tap , and, if prompted, select the account that the contact will be added to.
4. Tap **[Group's name]** and enter a name for the group.
5. Tap **[Type person's name]**, enter the name of someone you want to add to the group, and then tap the person's name when it is displayed.
  - You can also add a contact to a group later by editing the contact.
6. Tap **[DONE]**.

### Deleting a group

1. Tap **[People]** in the Home screen or app list.
2. Tap the  tab.
3. Select the desired group and then tap  → **[Delete]** → **[OK]**.
  - Contacts in the group will not be deleted.

## Sharing and backing up contacts

---

### Sharing a contact

1. Tap **[People]** in the Home screen or app list.
2. Select the desired contact.
  - You can select your contact information as well as other people's contact information.
3. Tap  → **[Share]**.
4. Select the desired method and then follow the on-screen instructions.
  - When sharing contacts with a *Bluetooth*-compatible device, make sure the other device's *Bluetooth* feature is turned on and that the device is set to discoverable mode.

### Sharing multiple contacts

You can share all contacts displayed on the contacts screen. You can use this feature to backup all your contacts, or search for certain contacts and narrow the items down before sharing them.

1. Tap **[People]** in the Home screen or app list.
2. Tap  → **[Import/export]** → **[Share visible contacts]**.
3. Select the desired method and then follow the on-screen instructions.
  - When sharing contacts with a *Bluetooth*-compatible device, make sure the other device's *Bluetooth* feature is turned on and that the device is set to discoverable mode.

### Note

- Group names are not sent when exporting contacts using this method.

### Backing up contacts

You can back up all your contacts to the phone's USB storage.





1. Tap **[People]** in the Home screen or app list.
2. Tap  → **[Import/export]** → **[Export to storage]** → **[OK]**.

# Email

## Using email

### Composing and sending an email message

If you need to add an email account to your phone, see “Account settings” (page 17).

1. Tap **[Email]** in the Home screen or app list.
  - If you have multiple accounts, you can select the account from which your message will be sent. Tap the folder name in the upper-left corner of the screen and then select the desired account.
2. Tap .
3. Enter the appropriate information in the **[To]**, **[Subject]**, and **[Compose email]** fields.
  - To add Cc and/or Bcc, tap  → **[Add Cc/Bcc]**.
  - When entering an email address manually, you can enter multiple email addresses by separating them with a semicolon or comma.
  - To attach a file, tap  → **[Attach file]** and then select a file.
4. Tap .
  - If the phone cannot access the Internet, the message will be saved in the outbox and will be sent later when the phone can once again access the Internet.
  - You can save a message as a draft before sending the message by tapping . To resume composing the draft message, tap the folder name in the upper-left corner of the screen, select the **[Drafts]** folder (you may need to tap **[Show all folders]** first), and then select the desired draft message.

#### Note



- If the recipient’s device or email service provider rejects email messages that were sent from a computer, email messages sent from your phone will also be rejected.

### Reading email messages

When an email message is received,  is displayed on the left side of the status bar. To read the message, you can open the notifications panel and tap the new message notification, or follow the instructions below.

1. Tap **[Email]** in the Home screen or app list.
2. Tap the folder name in the upper-left corner of the screen and then select the desired inbox.
  - If you have multiple accounts, you can check messages received by all accounts by tapping **[Combined view]**.
  - Tap  to manually refresh the current list and receive any new email messages waiting for you. Note that this feature is not available when you have selected **[Combined view]**.
3. Select the desired message.

#### Note

- While reading a message, you can tap  and  to view other messages.
- You can change text size used for displaying messages by tapping  → **[Settings]** → **[General]** → **[Message text size]**.





### Saving or viewing an email message attachment

1. Tap **[Email]** in the Home screen or app list.
2. Select the desired message.
3. Tap the attachment tab and then tap **[SAVE]** or **[VIEW]**.

### Adding a sender's email address to your contacts

1. Tap **[Email]** in the Home screen or app list.
2. Select the desired message.
3. Tap the sender's image icon at the top of screen and then tap **[OK]**.
4. To add the sender to an existing contact:  
→ Tap the desired contact.  
To add the sender to a new contact:  
→ Tap **[CREATE NEW CONTACT]**.
5. Enter or edit the information as needed and tap **[OK]** or **[DONE]**.



### Replying to and forwarding an email message

1. Tap **[Email]** in the Home screen or app list.
2. Select the desired message.
3. To reply to the sender only:  
→ Tap .  
To reply to the sender and to all recipients:  
→ Tap  in the sender's header and then tap **[Reply all]**.  
To forward the message:  
→ Tap  in the sender's header and then tap **[Forward]**.
4. Compose the message and then tap .

## Managing email messages

---

### Deleting an email message



1. Tap **[Email]** in the Home screen or app list.
2. Turn on the checkbox next to the message that you want to delete.
  - You can turn on checkboxes for additional messages and select them to be deleted.
  - You can cancel without deleting any messages by tapping .
3. Tap .

#### Note





- You can also delete a message while reading it by tapping .

### Moving an email message to another folder

You can organise your email messages by saving them in folders. Note that the folders that are available vary depending on your email service provider.



1. Tap **[Email]** in the Home screen or app list.
2. Turn on the checkbox next to the message that you want to move.
  - You can turn on checkboxes for additional messages and select them to be moved.
  - You can cancel without moving any messages by tapping .
3. Tap  and then select the desired folder.

### Marking a message as read or unread

1. Tap **[Email]** in the Home screen or app list.
2. Turn on the checkbox next to the message that you want to mark.
  - You can turn on checkboxes for additional messages and select them to be marked.
  - You can cancel without marking any messages by tapping .
3. Tap  (to mark as unread) or  (to mark as read).
4. Tap  when finished.

### Searching for an email message

You can search for email messages containing specific text in the message body or subject, and search for email messages to and from specific people. Note that you cannot search by entering partial words or names.

1. Tap **[Email]** in the Home screen or app list.
2. Tap .
  - Note that this feature is not available when you have selected **[Combined view]**.
3. Enter the text or name to search for, and then tap .

## Using email accounts

### Adding an email account to your phone

See “Account settings” (page 17).

### Setting an email account as the default account

You can specify an email account that will be used as the default account when composing and sending email messages.

1. Tap **[Email]** in the Home screen or app list.
2. Tap  → **[Settings]** and then select the desired account.
3. Turn on the **[Default account]** checkbox.

### Removing an email account from the phone

1. Tap **[Email]** in the Home screen or app list.
2. Tap  → **[Settings]** and then select the desired account.
3. Tap **[Remove account]** → **[OK]**.

### Changing an email account settings

You can change various settings for an email account such as **[Account name]**, **[Signature]**, and **[Inbox check frequency]**.

1. Tap **[Email]** in the Home screen or app list.
2. Tap  → **[Settings]** and then select the desired account.
3. Select the desired setting and then change the setting.

## Gmail

The **[Gmail]** app is an email app that functions similarly to the **[Email]** app, but is designed for use with Gmail accounts only. When using the **[Gmail]** app, refer to the information provided in “Using email” (page 37).

If you have a Google account, but have not yet registered the account to your phone, you will be prompted to enter your Google account information the first time you use the **[Gmail]** app.

# Messaging





## Using text and multimedia messaging

You can use your phone to send and receive text messages using SMS (Short Message Service). If you have subscribed to your mobile network operator's MMS (Multimedia Messaging Service), you can also send and receive messages that contain media files, such as pictures and videos. For details about these services, contact your mobile network operator.

### Note

- SMS messages are typically limited to 160 characters. This limit may vary depending on the region and the language.
- You may incur additional charges if you send or receive messages while roaming. Contact your mobile network operator for details.

### Composing and sending a message

1. Tap **[Messaging]** in the Home screen or app list.
2. Tap .
3. Enter the appropriate information in the **[To]** and **[Type message]** fields.
  - To attach a file, tap , select the desired option, and then follow the on-screen instructions.
  - To add a subject or select other options, tap  and then select the desired option.
4. Tap 
  - You can save a message as a draft before sending the message by tapping  in the upper-left corner of the screen. The message will be saved and **[Draft]** will be displayed in the conversation header. To resume composing the draft message, tap the conversation.

### Reading a received message

When a message is received,  is displayed on the left side of the status bar. To read the message, you can open the notifications panel and tap the new message notification, or follow the instructions below.

1. Tap **[Messaging]** in the Home screen or app list.
2. Tap the conversation.

### Replying to a message

1. Tap **[Messaging]** in the Home screen or app list.
2. Tap the conversation.
3. Enter a reply in the **[Type message]** field.
4. Tap .

### Forwarding a message

1. Tap **[Messaging]** in the Home screen or app list.
2. Tap the conversation.
3. Tap and hold the message and then tap **[Forward]**.
4. Specify the recipient in the **[To]** field.
5. Tap .



### Deleting a message

1. Tap **[Messaging]** in the Home screen or app list.
2. Tap the conversation.
3. Tap and hold the message, and then tap **[Delete]** → **[Delete]**.



### Searching for a message

You can search for messages containing specific text.

1. Tap **[Messaging]** in the Home screen or app list.
2. Tap .
3. Enter the text and then tap .

### Locking a message to prevent deletion

You can lock individual messages in a conversation. If you delete the conversation later, the locked messages will be retained.

1. Tap **[Messaging]** in the Home screen or app list.
2. Tap the conversation.
3. Tap and hold the message and then tap **[Lock]**.
  -  is displayed next to locked messages.

### Deleting a conversation

1. Tap **[Messaging]** in the Home screen or app list.
2. Tap and hold the conversation.
  - Once you tap and hold a conversation, you can tap other conversations and select them for deletion.
3. Tap  → **[Delete]**.
  - Locked messages will not be deleted.

### Deleting all conversations

1. Tap **[Messaging]** in the Home screen or app list.
2. Tap  → **[Delete all threads]** → **[Delete]**.
  - Locked messages will not be deleted.

### Adding a sender's number to your contacts

1. Tap **[Messaging]** in the Home screen or app list.
2. Tap the conversation.
3. Tap  → **[Add to People]**.

### Calling a message sender

1. Tap **[Messaging]** in the Home screen or app list.
2. Tap the conversation.
3. Tap .

### Saving a file attachment

1. Tap **[Messaging]** in the Home screen or app list.
2. Tap the conversation.
3. If the file has not been downloaded yet, tap **[Download]**.
4. Tap and hold the file and then select the desired option.

### Changing messaging settings

You can customise the **[Messaging]** app to suit your needs by configuring various settings, such as the maximum number of messages per conversation, whether notifications are displayed, the ringtone heard when new messages are received, etc.

1. Tap **[Messaging]** in the Home screen or app list.
2. Tap  → **[Settings]**.
3. Configure the desired settings.

## Talk



---

You can use the Google Talk instant messaging app to have text, voice, and video chats with friends.

### Adding a friend to your friend list

1. Tap **[Talk]** in the Home screen or app list.
2. Select the desired account if necessary.
3. Tap .
4. Enter the email address of the friend then tap **[DONE]**.
  - When your friend accepts the invitation, the friend is added to your friend list.

### Starting a chat

1. Tap **[Talk]** in the Home screen or app list.
2. Select a friend in the friend list.
3. To send a text message:  
→Enter a message in the text box and then tap .
- To start a voice chat:  
→Tap .

### Note

- Certain chat options may not be available depending on the type of device the other person is using, network conditions, etc.

### Reading a message

When a message is received,  is displayed on the left side of the status bar. To read the message, you can open the notifications panel and tap the new message notification, or follow the instructions below.

1. Tap **[Talk]** in the Home screen or app list.
2. Tap the conversation.

# Browser

Your phone includes a full-featured web browser that allows you to view web pages, manage bookmarks, download pictures and files, etc.

## Note

- A data plan is required to access the Internet when using your operator's mobile network. Contact your mobile network operator regarding data plans and rates.
- Additional charges may be incurred for accessing the Internet or downloading media files from the Internet while connected to the mobile network. Contact your mobile network operator for more information.

## Browsing the web

### Viewing a web page

1. Tap **[Browser]** in the Home screen or app list.
2. Enter the web address in the address bar and then tap **[Go]**.

### Searching for a web page

1. Tap **[Browser]** in the Home screen or app list.
2. Enter the search text in the address bar and then tap **[Go]**.
  - You can also tap  next to the address bar and speak the desired search text.
  - If the address bar is not displayed, flick down (scroll up) to display it.

## Note



- You can also search for a web page directly from the Home screen by using the Google Search widget. You can add the widget to your Home screen if necessary ("Adding an item in the app list to the Home screen" (page 13)).

### Viewing a previously viewed web page

1. Tap **[Browser]** in the Home screen or app list.
2. Tap  → **[Bookmarks]**.
3. Select the desired tab and browse for the desired web page.
  - You can browse your bookmarks, browsing history, and saved web pages.

### Viewing a web page privately

You can use the **[Browser]** app's "incognito tab" feature to browse privately. When using an incognito tab to browse the web, search history is not retained, and the web sites you visit are not retained in the browsing history once you close the incognito tab. Note that any files you download will be retained.

1. Tap **[Browser]** in the Home screen or app list.
2. Tap  →  → **[New incognito tab]**.
3. Search for or access the desired web page.

## Navigating web pages

### Zooming in and out on a web page while browsing

Using two fingers, "pinch" together two points on the touch panel screen to zoom out, and push apart two points on the touch panel screen to zoom in. You can also zoom in and out by double-tapping.

### Returning to the previous web page while browsing

Tap ↶.

### Using a link to open another web page while browsing

Tap the link. To open the link in a new window, tap and hold the link until the menu appears, and then tap **[Open in new tab]**.

### Searching for text within a web page while browsing

1. Tap ☰ → **[Find on page]**.
2. Enter the desired text in the search bar.
3. Tap ^ or v to highlight the previous or next instance of the text.
4. Tap ✓ to close the search bar.

### Using tabs

Tabs allow you to open several web pages at the same time. Tap ☰ and then + to open a new tab while browsing. Tap ☰ and then select a different tab to switch to a different tab while browsing. While viewing the list of web pages, drag a web page to the left or right, or tap ×, to delete the web page from the list.

### Sharing a link to the current web page while browsing

1. Tap ☰ → **[Share page]**.
2. Select the desired method and then follow the on-screen instructions.
  - When sharing a link with a *Bluetooth*-compatible device, make sure the other device's *Bluetooth* feature is turned on and that the device is set to discoverable mode.

## Bookmarking your favourite web pages

---

Bookmarks allow you to access your favourite web pages quickly and without entering the web address each time you access the page. Depending on your mobile operator, your phone may have bookmarks preinstalled.

### Adding a bookmark

1. While viewing the desired page, tap ☰ → **[Save to bookmarks]**.
2. Edit the name and web address of the web page as desired.
3. Tap the setting displayed next to **[Add to]** and then tap **[Bookmarks]**.
4. Tap **[OK]**.

### Opening a bookmark

1. Tap **[Browser]** in the Home screen or app list.
2. Tap ☰ → **[Bookmarks]**.
3. Select the desired bookmark.

### Editing a bookmark

1. Tap **[Browser]** in the Home screen or app list.
2. Tap ☰ → **[Bookmarks]**.
3. Tap and hold the desired bookmark and then tap **[Edit bookmark]**.
4. Edit the name and web address of the web page as desired and then tap **[OK]**.

### Deleting a bookmark

1. Tap **[Browser]** in the Home screen or app list.
2. Tap ☰ → **[Bookmarks]**.

3. Tap and hold the desired bookmark and then tap **[Delete bookmark]** → **[OK]**.

#### Adding a web page shortcut to the Home screen

1. While viewing the desired page, tap  → **[Save to bookmarks]**.
2. Edit the name and web address of the web page as desired.
3. Tap the setting displayed next to **[Add to]** and then tap **[Home screen]**.
4. Tap **[OK]**.

## Downloading from web pages

### Downloading a file from a web page

1. While viewing the desired page, tap and hold the desired image or file name link.
2. Select the desired option.

#### Note

- Downloaded files could contain viruses. Make sure you only download files from trusted sources.

### Cancelling a download or deleting a downloaded file

You can manage downloads using the **[Downloads]** app.

1. Tap **[Downloads]** in the Home screen or app list.
2. Turn on the checkbox for the desired file and then tap .

### Viewing a downloaded file

1. Tap **[Downloads]** in the Home screen or app list.
2. Select the desired file.
3. If prompted, select the app to be used to open the file.

### Sharing a downloaded file

1. Tap **[Downloads]** in the Home screen or app list.
2. Tap and hold the desired file and then tap .
3. Select the desired method and then follow the on-screen instructions.
  - When sharing a file with a *Bluetooth*-compatible device, make sure the other device's *Bluetooth* feature is turned on and that the device is set to discoverable mode.

## Using the web browser's options menu

The options menu provides quick access to various features of the web browser. Some commonly used features are described below. You can open the options menu by tapping  while viewing a web page.

- **[Refresh]**: Reloads the current web page.
- **[Save for offline reading]**: Saves the current web page so that you can view it later, even if your phone cannot connect to the Internet.
- **[Settings]**: Displays a list of web browser settings.

## Changing web browser settings

You can customise the web browser to suit your needs by configuring various settings, such as the web site used for web searches, how web pages are displayed, etc. Some commonly used settings are described below. You can open the settings menu by tapping  → **[Settings]** while viewing a web page.

## Browser

---

- **[General]** → **[Set homepage]**: Sets the web page that opens when you open a new web browser window.
- **[Privacy & security]** → **[Clear history]**: Clears the content of the **[HISTORY]** tab.
- **[Accessibility]** → **[Text scaling]**: Changes the text size displayed in the web browser.
- **[Advanced]** → **[Set search engine]**: Changes the web site used for web searches.

# Play Music

The **[Play Music]** app gives you instant access to your music collection stored on your phone.

## Note

- App features, service availability, and service content may vary by region.

## Copying audio files to your phone

The **[Play Music]** app detects supported audio files stored in your phone and allows you to listen to them. For information about copying data between your computer and phone, see “Copying data between your computer and the phone via USB” (page 69).

This app supports various audio file formats, including MP3, AAC, M4A, AMR, MIDI, and OGG Vorbis. Supported formats may vary depending on the software version.









## Listening to your music

### Browsing your music library

1. Tap **[Play Music]** in the Home screen or app list.
2. Flick left and right to select a category (playlists, artists, songs, etc.) at the top of the screen.
3. Scroll through the list and tap a song that you want to play.

### Using the playback controls

You can tap the album artwork for the current song to hide and show detailed playback controls.

-  Tap to pause playback.
-  Tap to start or resume playback.
-  Tap to repeat the current song from the beginning or skip to the previous song.
-  Tap to skip to the next song.
-  Drag to play a different region of the song.
-  Tap to rate the song “thumbs up” and add the song to the **[Thumbs up]** playlist. Tap again to remove the rating.
-  Tap to rate the song “thumbs down”. Tap again to remove the rating.
-  Tap to turn shuffle playback on and off. When turned on, songs are played in random order.
-  Tap to turn continuous playback on and off. When turned on, the current song or collection of songs (e.g., album, playlist) plays repeatedly.

### Using the options menu

Additional options are available while browsing by tapping  next to a song title, artist name, playlist, etc. Some commonly used options are described below.

- Tap **[Play]** to play the song or playlist.
- Tap **[Add to playlist]** to add the item to a playlist.
- Tap **[More by artist]** to view more songs by the selected artist.
- Tap **[Remove from playlist]** to remove the song from the playlist.
- Tap **[Rename]** to rename the playlist.
- Tap **[Delete]** to delete the current song.

### Adjusting the equaliser

While playing a song, tap  → **[Equaliser]**.

## Using playlists

---

### Adding a song to a playlist

You can create and manage playlists of your favourite songs.

1. Tap **[Play Music]** in the Home screen or app list.
2. Tap and hold a song title until the context menu appears.
  - You can also tap and hold artist names and album titles.
3. Tap **[Add to playlist]**.
4. Add the item to a new playlist or select an existing playlist.

### Playing a song in a playlist

1. Tap **[Play Music]** in the Home screen or app list.
2. Select a playlist and then select a song to play.
  - If you tap  while listening to a song, the song is added to the **[Thumbs up]** playlist.

### Removing a song from a playlist

While browsing a playlist, tap and hold the song title and then tap **[Remove from playlist]**.

### Changing the order of songs in a playlist

While browsing a playlist, tap and drag the left side of a song title up and down to change the order.

### Renaming a playlist

1. Tap **[Play Music]** in the Home screen or app list.
2. Tap and hold a playlist until the context menu appears.
3. Tap **[Rename]**.
4. Enter the new name and tap **[Rename]**.

### Deleting a playlist

1. Tap **[Play Music]** in the Home screen or app list.
2. Tap and hold a playlist until the context menu appears.
3. Tap **[Delete]** → **[OK]**.

### Playing music in the background

While playing music, tap  to return to the Home screen. You can use other apps while playing music in the background. To return to the **[Play Music]** app, open the notifications panel and then tap the name of the current song.



# Camera

## Taking pictures and recording videos

Your phone offers a full-featured camera that can shoot pictures and record videos.

Launch the **[Camera]** app by tapping **[Camera]** in the Home screen or app list.



### Note

- If the power turns off or the phone becomes excessively hot or cold when shooting a still image or recording a movie, the image or movie may not be saved, or the saved file may be unplayable.

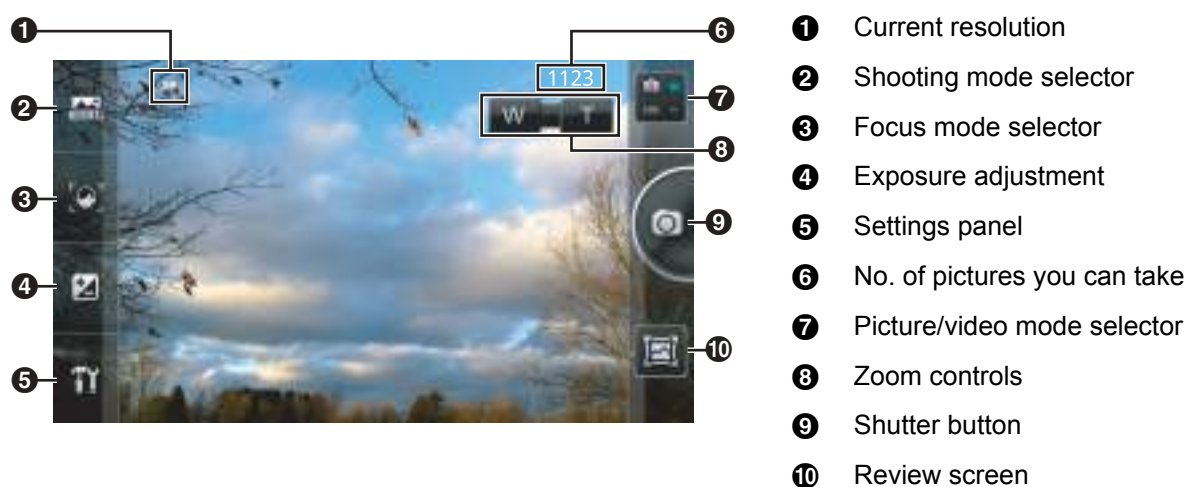
### Picture mode screen



### Taking a picture

1. Tap **[Camera]** in the Home screen or app list.
2. Tap  to select picture mode if necessary.
3. Select the desired shooting mode, options, and zoom.
4. Hold the phone steady and tap .
  - The phone captures an image, saves it, and displays the picture in the review screen (“Viewing recent pictures and videos” (page 50)).

### Video mode screen

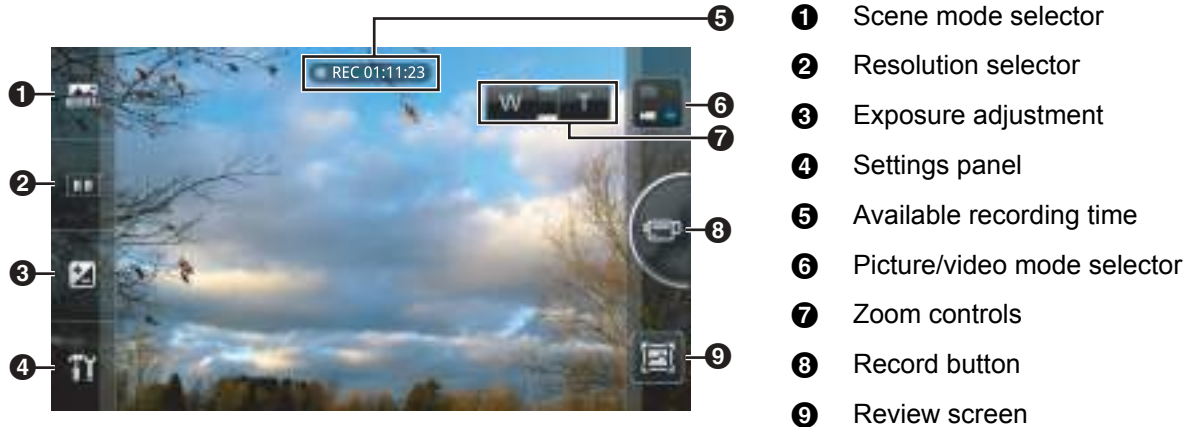

### Recording a video

1. Tap **[Camera]** in the Home screen or app list.
2. Tap to select video mode if necessary.
3. Select the desired scene mode, options, and zoom.
4. Hold the phone steady and tap .
5. Tap to stop recording.
  - The phone saves the video and displays the video in the review screen (“Viewing recent pictures and videos” (page 50)).

### Zooming

Tap and to zoom in and out. You can also use the zoom slider while it is displayed.

#### **Note**

- You cannot adjust the zoom while recording videos. Adjust the zoom before recording.

### Viewing recent pictures and videos

The review screen is displayed after you take a picture or finish recording a video. You can also open the review screen by tapping . The following operations are available in the review screen depending on the camera settings.

- Flick left and right to browse.
- Tap to return to the camera.
- Tap to delete the current picture or video.
- Tap to share the current picture or video using the desired method.
  - When sharing a picture or video with a *Bluetooth*-compatible device, make sure the other device’s *Bluetooth* feature is turned on and that the device is set to discoverable mode.
- Tap to display information about the current picture or video.
- Tap to delete the current picture or video and return to the camera.
- Tap to confirm the area selected for a contact’s picture and add the picture to one of your contacts, or confirm the video captured for video upload.

## Changing picture mode settings

The following settings are available when using picture mode.

### [Shooting Mode]

Select a shooting mode according to the kind of pictures you want to take. You can also use the **[Scene]** mode for more options.

- [Normal]** Use this mode for typical picture taking.
- [Panorama]** Allows you to take panorama pictures. After you take the first picture, move the camera up, down, left, or right until the green box lines up with the white box. Once the two boxes are lined up, the camera takes the next picture automatically. Continue moving the camera in the same direction to take more pictures until the panorama is complete.
- [Smile]** Allows you to take pictures automatically once the subject smiles.
- [Burst]** Allows you to take a series of up to 7 pictures. The phone takes pictures for as long as you tap and hold .
- [Contact ID]** Allows you to take a picture of someone and add it to your contacts.
- [Frame]** Allows you to add fun frames to your pictures.
- [Collage]** Allows you to take multiple pictures and put them in a fun template.
- [Beauty]** Allows you to give skin a soft appearance in your pictures.
- [Stabilization]** Allows you to take pictures automatically as soon as the phone is held still.
- [Pinhole]** Allows you to take pictures with blurred dark edges.

### [Focus Mode]

Select a focus mode depending on the shooting conditions and the desired subject.

- [Auto]** When you tap , the phone focuses on the subject in the centre of the screen and takes a picture.
- [Infinity]** The phone focuses on distant landscapes.
- [Object]** Allows you to focus on a subject by simply tapping the desired subject on the screen. If the subject moves, or if you move the phone, the phone will track the movement and continue to focus on that subject.
- [Face]** The phone focuses on faces.
- [Continue]** The phone continually adjusts its focus according to the subject in the centre of the screen.
- [Macro]** Select this mode when shooting objects that are very close to the phone.
- [Touch]** Allows you to focus on a subject by simply tapping the desired subject on the screen.

### Exposure

Allows you to adjust brightness.

## Settings panel

|                           |  |
|---------------------------|--|
| <b>[Scene]</b>            | Select a scene mode according to the shooting conditions and the kind of pictures you want to take.  |
|                           | <b>Note</b>  |
|                           | <ul style="list-style-type: none"> <li>Certain scene modes are not available depending on the current shooting mode.</li> </ul>                                      |
| <b>[Normal]</b>           | The phone sets the shutter speed and aperture value according to the brightness of the subject.  |
| <b>[Portrait]</b>         | Makes skin tones look healthier.   |
| <b>[Landscape]</b>        | Allows you to take pictures of wide landscapes by giving priority focus to distant subjects.   |
| <b>[Night]</b>            | Uses slower shutter speeds to allow you to capture vivid nightscape pictures.  |
| <b>[Sports]</b>           | Allows you to take pictures of fast-moving subjects by increasing the shutter speed. Most effective when shooting in the daytime under clear skies.                  |
| <b>[Food]</b>             | Allows you to take pictures of food that have a natural hue, without being affected by the ambient light in kitchens, restaurants, etc.                              |
| <b>[Backlight]</b>        | Compensates when the light source is behind the subject by brightening the subject.  |
| <b>[Character]</b>        | Useful for taking pictures of railway timetables, maps, etc.   |
| <b>[Snow]</b>             | Adjusts the exposure and white balance to help your pictures of the snow appear as white as possible.  |
| <b>[Sunset]</b>           | Allows you to take vivid pictures of sunsets.  |
| <b>[Pet]</b>              | Use this mode when taking pictures of animals.   |
| <b>[Effect]</b>           | Allows you to select a colour effect.  |
| <b>[Self Timer]</b>       | The self timer allows you to take pictures 3, 5, or 10 seconds after you tap  . |
| <b>[Photo Resolution]</b> | Allows you to select the size at which pictures are captured.  |
| <b>[Photo Quality]</b>    | Allows you to select the quality at which pictures are captured.   |
| <b>[White Balance]</b>    | Allows you to adjust overall image colour based on the lighting conditions where you are taking pictures.  |
| <b>[ISO]</b>              | Determines how sensitive the lens is to light.   |
| <b>[Brighten]</b>         | Brightens dark areas in pictures.  |
| <b>[GPS Location]</b>     | Determines if location information is attached to pictures.  |
| <b>[Show Grid]</b>        | Determines if a grid is shown on the screen.   |
| <b>[Review]</b>           | Determines whether the review screen is displayed after you take a picture.  |
| <b>[Reset]</b>            | Resets all picture mode settings to their default values.  |

## Changing video mode settings

The following settings are available when using video mode.

### [Scene Mode]

Select a scene mode according to the shooting conditions and the kind of videos you want to take.

|                    |   |
|--------------------|---|
| <b>[Normal]</b>    | Use this mode for typical video recording.  |
| <b>[Portrait]</b>  | Makes skin tones look healthier.  |
| <b>[Landscape]</b> | Allows you to record videos of wide landscapes by giving priority focus to distant subjects.  |
| <b>[Night]</b>     | Uses slower shutter speeds to allow you to capture vivid nightscape videos.   |
| <b>[Sports]</b>    | Allows you to record videos of fast-moving subjects by increasing the shutter speed. Most effective when shooting in the daytime under clear skies. |
| <b>[Food]</b>      | Allows you to record videos of food that have a natural hue, without being affected by the ambient light in kitchens, restaurants, etc.             |
| <b>[Backlight]</b> | Compensates when the light source is behind the subject by brightening the subject.   |
| <b>[Character]</b> | Useful for recording videos of railway timetables, maps, etc.   |
| <b>[Snow]</b>      | Adjusts the exposure and white balance to help your videos of the snow appear as white as possible.   |
| <b>[Sunset]</b>    | Allows you to record sunsets in vivid colour.   |
| <b>[Pet]</b>       | Use this mode when recording videos of animals.   |

### [Resolution Mode]

Allows you to select the size at which videos are recorded.

### Exposure

Allows you to adjust brightness.

### Settings panel

|                        |  |
|------------------------|--|
| <b>[White Balance]</b> | Allows you to adjust overall image colour based on the lighting conditions where you are recording videos. |
| <b>[Effect]</b>        | Allows you to select a colour effect.  |
| <b>[Video Quality]</b> | Allows you to select the image quality of recorded videos.   |
| <b>[Audio Record]</b>  | Determines whether audio is also recorded when you record videos.  |
| <b>[Review]</b>        | Determines whether the review screen is displayed after you record a video.                                |
| <b>[Shot mode]</b>     | Select <b>[Mail]</b> to limit recorded videos to 2 MB.   |
| <b>[Reset]</b>         | Resets all video mode settings to their default values.  |

## Viewing your pictures and videos

You can use the **[Picture Album]** app to view your pictures and videos.

This app supports various image file formats, including JPG, BMP, GIF, PNG, and MPO, and video formats, including MP4, 3GP, and WebM.

### Browsing your picture album

You can use the **[Picture Album]** app to view your pictures and videos. Files can be viewed by category, such as folder, date, and location.

1. Tap **[Picture Album]** in the Home screen or app list.
2. Tap the category name in the upper-left corner of the screen and then select the desired category.
3. Tap a group of files.
4. Tap a picture or video to view it in full-screen mode.
5. Scroll left and right to preview more files.

### Viewing pictures in a slideshow

While a group of files is displayed, tap .

### Viewing pictures on a map

If a picture in your picture album has location information attached to it (determined by the **[Camera]** app's **[GPS Location]** setting), you can view it on a map by tapping  → **[Show on map]**.

### Using Picture Jump

Picture Jump makes it easy to send files to other apps, share files with your friends, delete files, etc.

1. While browsing your picture album, tap and hold the desired file or group of files.
  - The selected file or group of files is highlighted to indicate that it is selected.
  - Once a file or group of files is selected, you can select more items by tapping them.
2. Tap and hold a selected item, and then drag your selection to the desired location on the screen to activate the corresponding Picture Jump feature.

#### Note

- You can change the features assigned to Picture Jump by tapping  → **[Picture Jump settings]** from the top screen of **[Picture Album]**.
- When sharing a picture or video with a *Bluetooth*-compatible device, make sure the other device's *Bluetooth* feature is turned on and that the device is set to discoverable mode.



## Editing pictures

---



You can use the **[Picture Album]** app to edit your pictures. Some commonly used editing features are explained in this section.

In order to edit a picture, first browse for and display the picture you want to edit ("Browsing your picture album" (page 54)).

### Applying an effect



1. While viewing a picture in full-screen mode, tap  → **FX**.
  - A palette of effects is displayed. Flick left and right to view the various effects.
  - Other effects and tools are available by tapping .
2. Select the desired effect.
3. Use the slider to adjust the amount of effect applied.
  - The slider may not be available depending on the effect you selected.
4. Use other editing tools to continue editing the picture, or tap **[SAVE]**.
  - The edited picture is saved in the **[Edited]** album. The original picture is retained.

### Drawing on pictures



1. While viewing a picture in full-screen mode, tap  → .

2. Select the desired colour and then draw on the picture.
  - While drawing, you can change the colour and continue drawing in a different colour.
3. Use other editing tools to continue editing the picture, or tap **[SAVE]**.
  - The edited picture is saved in the **[Edited]** album. The original picture is retained.

### Adjusting lighting and colours

1. While viewing a picture in full-screen mode, tap  → .
  - A palette of lighting and colour settings is displayed. Flick left and right to view the various settings.
2. Select the desired setting.
3. Use the slider to adjust the lighting or colour.
  - The slider may not be available depending on the setting you selected.
4. Use other editing tools to continue editing the picture, or tap **[SAVE]**.
  - The edited picture is saved in the **[Edited]** album. The original picture is retained.

### Cropping a picture

1. While viewing a picture in full-screen mode, tap  → .
  - A palette of tools is displayed. Flick left and right to view the various tools.
2. Tap **[Crop]**.
3. Adjust the size and location of the crop box and then tap .
4. Use other editing tools to continue editing the picture, or tap **[SAVE]**.
  - The edited picture is saved in the **[Edited]** album. The original picture is retained.

### Adding tags to a picture

You can add tags (keywords) to your pictures so that you can browse your pictures by tag.

1. While viewing a picture in full-screen mode, tap  → **[Tag settings]**.
2. Enter the desired tags.
3. Tap **[Set]**.

#### **Note**

- To browse your pictures by tag, tap the category name in the upper-left corner of the screen and then tap **[Tags]**.

# Location services

You can use your phone to find your location. Different apps can use this information to provide a variety of services, such as helping you find nearby shops and restaurants, adding location information to pictures you take with your phone, or showing you your location on a map.

Your phone can calculate its approximate location based on nearby wireless networks and by using its GPS (Global Positioning System) antenna, which receives signals from satellites. Using wireless networks to determine location is faster but less precise; using GPS is more precise but generally slower and requires a visible sky. You can enable and disable each of these features, and you can enable both if preferred.

## **Note**

- The accuracy of location services cannot be guaranteed.

## Enabling GPS-based location services

1. From the Home screen, tap  → **[Settings]**.
2. Tap **[Location services]**.
3. Turn on the **[GPS satellites]** checkbox.

## **Note**

- GPS-based location services require a visible sky.
- GPS signal reception may be poor in areas surrounded by buildings, where there is electrical interference, etc.

## Enabling wireless network-based location services

1. From the Home screen, tap  → **[Settings]**.
2. Tap **[Location services]**.
3. Turn on the **[Google's location service]** checkbox.

# Maps

---





You can use the **[Maps]** app to find your current location and get information specific to your location, such as directions and traffic information.

Launch the **[Maps]** app by tapping **[Maps]** in the Home screen or app list.

## **Note**

- This app requires an Internet connection.
- Maps, place information, and other features may not be available in certain regions.

## Using **[Maps]**

-  Allows you to enter text and search for places on the map. You can search by name, address, and location type (e.g., "post office").
-  Allows you to get detailed directions for travelling by car, public transportation, etc.
-  Allows you to search for specific categories of place, such as restaurants and coffee shops
-  Allows you to show specific information on the map, such as traffic information and transit lines
-  Finds your current location on the map



- Switches to compass mode. Your position indicator on the map will rotate to match the direction the phone is facing while the map stays stationary. Tap again and the map will rotate to match the direction the phone is facing while the position indicator stays stationary.

### Viewing details about a place

1. Search for the desired place on the map.
2. Tap the name of the place on the map, or tap and hold any area of the map.
  - The name of the place is displayed in a text bubble.
3. Tap the text bubble to display details about the place and other options.





### Viewing the help site

While viewing the map, tap  and then tap **[Help]**.

### Switching between features

Tap the feature name in the upper-left corner of the screen to view a list of available features and then select the desired feature.

### Getting directions

1. Tap **[Maps]** in the Home screen or app list.
2. Tap .
3. Specify the starting point and end point as desired.
  - You can enter an address stored in your contacts and select other options by tapping .
4. Select a mode of transportation (car, public transportation, etc.).
5. Tap **[GET DIRECTIONS]**.
  - Depending on the selected mode of transportation, you can tap  to get voice-guided navigation with turn-by-turn directions.
  - You can tap  and  to see a close-up of each section of the route.
  - You can tap **[DIRECTIONS LIST]** to see a list of the directions guiding you to your destination.

## Navigation

The **[Navigation]** app uses your phone's Internet connection and GPS antenna to provide voice-guided navigation with turn-by-turn directions.

### Note

- Navigation information may not be available in certain regions.

### Using **[Navigation]**

1. Tap **[Navigation]** in the Home screen or app list.
2. Flick left or right to select the desired page of options.
  - **[STARRED]**: Allows you to specify a destination by selecting it from your starred places that you created in **[Maps]**.
  - **[SHORTCUTS]**: Allows you to specify a destination using a variety of options.
  - **[CONTACTS]**: Allows you to specify a destination by selecting it from your contacts.
3. Select the desired item or option to enter your destination.
  - Some of the options available on the **[SHORTCUTS]** page are explained below.
    - **[Speak destination]**: Allows you to specify a destination by speaking it.
    - **[Type destination]**: Allows you to specify a destination by entering it with the keyboard.
    - **[Go home]**: Allows you to specify your home as the destination.
4. Follow the directions once they are displayed.

## Local

---

The **[Local]** app provides you with details about nearby places of interest.

### **Note**

- Maps, place information, and other features may not be available in certain regions.

### **Using [Local]**

1. Tap **[Local]** in the Home screen or app list.
2. Select a category and then select a place and view the information.
  - You can also search by tapping the search icon and entering the name of the place.
3. Tap the corresponding icon for more information, such as the phone number or to see the location on the map.

# Other apps

## NFC Starter

NFC tags are microchips that can be embedded in stickers, posters, plastic cards, etc. You may have an NFC tag embedded in your driver's licence, rail pass, or credit card. You can register NFC tags to the phone and use them to trigger actions on your phone, such as opening a frequently-used web site or app, changing the app used to display the Home screen, or unlocking the phone.

### Note

- In this document, NFC tags are referred to as "NFC cards".

### Registering an NFC card (NFC tag)

1. Tap **[NFC Starter]** in the Home screen or app list.
  - If an NFC card has already been registered, tap **[New]** to register an additional card.
2. Follow the on-screen instructions and touch the NFC card to the **[NFC]** mark on the rear of the phone.
3. Tap **[Yes]**.
4. Select the desired action.
  - **[Change Home screen]**: Allows you to configure the phone to change the app used to display the Home screen whenever you touch the NFC card to the phone.
  - **[Start app]**: Allows you to configure the phone to launch a specific app whenever you touch the NFC card to the phone.
  - **[Open web page]**: Allows you to configure the phone to open a specific web site whenever you touch the NFC card to the phone.
5. Follow the on-screen instructions.

### Note

- Refer to the information found in "Phone does not recognise my NFC card (NFC tag)" (page 87) when registering and using NFC cards.
- To use an NFC card to unlock your phone, see "Configuring the screen lock" (page 74).

### Initiating a registered action

Once you have registered an NFC card to the phone for use with **[NFC Starter]**, simply touch the NFC card to the **[NFC]** mark on the rear of the phone to initiate the action you selected at the time of registration.

### Changing the name assigned to an NFC card (NFC tag)

1. Tap **[NFC Starter]** in the Home screen or app list.
2. Select the desired item.
3. Tap **[Edit title]**.
4. Enter a name for the NFC card and tap **[OK]** → **[Yes]**.

### Deleting an NFC card (NFC tag)

1. Tap **[NFC Starter]** in the Home screen or app list.
2. Select the desired item.
3. Tap **[Delete]** → **[Yes]**.

## Calendar

The **[Calendar]** app allows you to create and manage your schedule.

### Note

- In order to use this app, you must register a Google account or a Microsoft Exchange ActiveSync account to the phone. See “Account settings” (page 17).

### Changing the calendar view



You can view your calendar by day, week, month, etc.

1. Tap **[Calendar]** in the Home screen or app list.
2. Tap the calendar view name in the upper-left corner of the screen.
3. Select the desired view option.

### Viewing multiple calendars

1. Tap **[Calendar]** in the Home screen or app list.
2. Tap  → **[Calendars to be displayed]**.
3. Turn on the checkboxes for the desired calendars.

### Creating an event

1. Tap **[Calendar]** in the Home screen or app list.
2. Tap  → **[New event]**.
3. Enter the event details.
  - You can specify a variety of details, including the following:
    - The account to which the event will be added (if you have multiple accounts registered to the phone)
    - Event name, location, and description
    - Start and end date and time, including time zone
    - Guests (people registered in your contacts will receive an email invitation to the event)
    - Reminder settings
  - If you set a reminder, your phone will remind you at the set time and  will be displayed in the status bar.
4. Tap **[DONE]**.

### Viewing a different time period

When viewing your monthly schedule, flick up and down to switch months. Tap a day to view your schedule for that day.

When viewing your weekly schedule, scroll up and down to look at your schedule for the week, and flick left and right to switch weeks.

When viewing your daily schedule, scroll up and down to look at your schedule for the day, and flick left and right to switch days.

### Viewing an event's details

Tap the desired event while viewing your daily or weekly schedule.

### Editing an event

1. Tap **[Calendar]** in the Home screen or app list.
2. Tap the desired event while viewing your daily or weekly schedule.
3. Tap .
4. Edit the event details and then tap **[DONE]**.

### Deleting an event

1. Tap **[Calendar]** in the Home screen or app list.
2. Tap the desired event while viewing your daily or weekly schedule.

3. Tap  → [OK].

### Dismissing or snoozing an event

1. When  appears in the status bar, open the notifications panel by tapping and holding the status bar and then sliding your finger down.
2. Tap the event.
3. Tap [**Snooze all**] or [**Dismiss all**].

### Changing calendar settings

1. Tap [**Calendar**] in the Home screen or app list.
2. Tap  → [**Settings**].
3. Change the settings as desired.

## Clock

You can use the [**Clock**] app as a desktop clock and have the clock's alarm sound at a specified time.

### Using the clock

Tap [**Clock**] in the Home screen or app list. While the time is displayed, you can tap a blank area of the screen to adjust the screen's brightness.

### Setting an alarm

1. Tap [**Clock**] in the Home screen or app list.
2. Tap  → [**Add alarm**].
  - You can also tap an existing alarm and change its settings.
3. Turn on the [**Turn alarm on**] checkbox.
4. Configure the alarm as desired, and then tap [OK].
  - When the alarm sounds, an alarm message will be displayed. Tap [**Snooze**] (to postpone the alarm) or [**Dismiss**] (to stop the alarm).

#### Note

- You can change the snooze time and other settings by tapping  → [**Settings**] → [**Snooze duration**].

### Turning an alarm on and off

1. Tap [**Clock**] in the Home screen or app list.
2. Tap .
3. Turn the checkbox next to the desired alarm on or off.

### Deleting an alarm

1. Tap [**Clock**] in the Home screen or app list.
2. Tap .
3. Select the desired alarm and then tap [**Delete**] → [OK].

## Notepad

The [**Notepad**] app is a simple text processor that allows you to enter text notes. You can enter and save several notes, and share the content of a note with other apps.

### Adding a new note

1. Tap **[Notepad]** in the Home screen or app list.
2. Tap **[New note]**.
3. Enter the title and then enter the note text.
4. Press ↵ twice when finished.

### Editing a note

1. Tap **[Notepad]** in the Home screen or app list.
2. Tap the desired note.
3. Edit the title and note text as desired.
4. Press ↵ twice when finished.

### Deleting a note

1. Tap **[Notepad]** in the Home screen or app list.
2. Tap and hold the desired note.
3. Tap **[Delete]** → **[OK]**.

### Sharing a note

1. Tap **[Notepad]** in the Home screen or app list.
2. Tap and hold the desired note.
3. Tap **[Share]**.
4. Select the desired method and then follow the on-screen instructions.
  - When sharing a note with a *Bluetooth*-compatible device, make sure the other device's *Bluetooth* feature is turned on and that the device is set to discoverable mode.

## YouTube

---

You can use your phone to access the YouTube video sharing service where you can view videos uploaded by other YouTube users. If you have a YouTube account, you can upload videos from your phone.

### Watching a video

1. Tap **[YouTube]** in the Home screen or app list.
2. Browse for and select the desired video.
  - Once playback begins, tap the video to display video playback controls.
  - You can rotate your phone and view videos in landscape viewing mode.

### Searching for a video

1. Tap **[YouTube]** in the Home screen or app list.
2. Tap 🔍.
3. Enter the search text and then tap 🔍.

#### **Note**

- You can delete the search history in the **[YouTube]** app's settings menu.

### Sharing a video link

1. Tap **[YouTube]** in the Home screen or app list.
2. Browse for and select the desired video.
3. Tap 📄.

4. Select the desired method and then follow the on-screen instructions.
  - When sharing a video link with a *Bluetooth*-compatible device, make sure the other device's *Bluetooth* feature is turned on and that the device is set to discoverable mode.

#### Uploading a video

1. Tap **[YouTube]** in the Home screen or app list.
2. Flick right to display the menu.
3. Tap your account name.
  - If you are not signed in, tap **[Sign in]** and enter your Google account information.
4. Tap **↑**.
5. Browse for and select the video stored on your phone that you want to upload.
6. Follow the on-screen instructions.

# Play Store

## Google Play

Google Play is an online service where you can buy apps and other content. You can use the **[Play Store]** app to purchase and download Google Play content.

### Note

- A Google account and Internet access are required to use **[Play Store]**.
- For more information about using Google Play and the **[Play Store]** app, tap ☰ → **[Help]**.
- Google Play and certain service content may not be available in certain regions.
- Google Play and the **[Play Store]** app were previously named “Android Market” and “Market”, respectively.

## Payment options

Google Play purchases are handled by Google Wallet. Google Wallet is an online payment processing service that provides services such as protection from credit card fraud and information about your purchase history.

### Note

- Paid content may not be available in certain regions.
- Direct carrier billing may also be available depending on your mobile operator and region.

## Finding and downloading apps

---

### Downloading an app

1. Tap **[Play Store]** in the Home screen or app list.
2. Search for the app that you want to download by looking through the various categories or using the search function.
3. Tap the app to see more information about it.
4. Follow the on-screen instructions to download and/or purchase the app.
  - An additional screen is displayed that informs you what the selected app can access if it needs to access data or control functions on your phone. Read this information carefully because it may dramatically change the performance and functionality of your phone.
5. If the app is a paid app, select the desired payment method to complete the purchase.

### Note

- You are responsible for the apps you download and the results of using downloaded apps on the phone.
- Some apps may connect to the Internet automatically and send or receive data. You may incur data transmission charges when the phone is using its mobile network connection to access the Internet.

## App management

---

### Clearing all data for an app

You can clear the data for an app. This may be necessary if the app’s memory becomes full, or if you want to delete incoming email, text, or other messages in an app, or clear a game’s high scores.

1. From the Home screen, tap ☰ → **[Settings]**.
2. Tap **[Apps]** and then select the desired app.
3. Tap **[Clear data]** → **[OK]**.



**Note**

- You may not be able to clear the data for some apps.

**Deleting an installed app**

1. From the Home screen, tap  → **[Settings]**.
2. Tap **[Apps]** and then select the desired app.
3. Tap **[Uninstall]** → **[OK]**.

**Note**

- You may not be able to delete some preinstalled apps.

**Viewing app permissions**

In order to perform properly, some apps must access information stored on your phone or information about your phone. For example, some apps may want to know your geographic location so that they can provide you with relevant information. Some apps could misuse their permission and report your location, or delete or steal your data. Only install and give permissions to apps that you trust.

1. From the Home screen, tap  → **[Settings]**.
2. Tap **[Apps]** and then select the desired app.
3. Confirm the desired items under the **[PERMISSIONS]** title.

**Allowing installation of apps from unknown sources**

Installing apps from unknown sources, such as services other than Google Play, may damage your phone. Installations from unknown sources are blocked by default, however, you may change this setting to allow installations from unknown sources.

1. From the Home screen, tap  → **[Settings]**.
2. Tap **[Security]**.
3. Turn on the **[Unknown sources]** checkbox.
4. Read the message and then tap **[OK]**.

# Connecting to other devices

## Bluetooth wireless technology

*Bluetooth* wireless technology enables short-range (about 10 m) communication, including voice, audio, and data transfer, between *Bluetooth*-compatible devices such as phones, hands-free accessories, and computers.

*Bluetooth* wireless technology allows you to take advantage of a wide variety of features. For example, you can connect a compatible headset and talk on the phone or listen to music, or connect to your car stereo and listen to music and other content stored on your phone through your car stereo and enjoy hands-free phone conversations in the car.

You can also use the following apps to send and receive data to and from other *Bluetooth*-compatible devices.

- **People** (see “Sharing and backing up contacts” (page 36))
- **Camera** (see “Viewing recent pictures and videos” (page 50))
- **Picture Album** (see “Using Picture Jump” (page 54))
- **Browser** (see “Sharing a link to the current web page while browsing” (page 44), “Sharing a downloaded file” (page 45))
- **Notepad** (see “Sharing a note” (page 62))
- **YouTube** (see “Sharing a video link” (page 62))



### Bluetooth settings

In order to use your phone with another *Bluetooth* device, you must first register your phone and the other device to each other. This is called “pairing”. In order to pair with each other, your phone and the other device must be able to find each other using *Bluetooth* wireless technology. This is done by making your phone “discoverable” by the other device, or vice versa.

#### **Note**

- Feature compatibility between *Bluetooth* devices may vary.

### Turning on the phone’s Bluetooth feature

1. From the Home screen, tap  → **[Settings]**.
2. Turn on the **[Bluetooth]** switch.
  - When the *Bluetooth* feature has been turned on,  appears in the status bar.

#### **Note**

- The phone’s *Bluetooth* feature is disabled when using the phone as a Wi-Fi hotspot.

### Pairing a Bluetooth device with the phone

Use this procedure to use your phone to initiate the pairing process, such as when pairing a *Bluetooth* headset.

1. From the Home screen, tap  → **[Settings]**.
2. Tap **[Bluetooth]**.
3. Set the other *Bluetooth* device to pairing mode or discoverable mode.
  - Refer to the operating instructions included with the other device for details.
4. Tap **[SEARCH FOR DEVICES]**.
  - **[SEARCHING]** is displayed while the phone searches for nearby *Bluetooth* devices.
  - The phone displays the names of any *Bluetooth* devices that can be discovered.
5. Tap the name of the device that you want to pair with the phone.

6. Follow the on-screen instructions.

**Note**

- You can confirm the pairing and connection status of other *Bluetooth* devices in the **[PAIRED DEVICES]** list.

**Connecting to a paired *Bluetooth* device**

Once you have paired another *Bluetooth* device with your phone, you may need to connect to the device in order to use it. (This is typically the case with *Bluetooth* headsets.)



1. From the Home screen, tap  → **[Settings]**.
2. Tap **[Bluetooth]**.
3. Tap the name of device in the **[PAIRED DEVICES]** list.

**Note**

- To disconnect a connected device, repeat this procedure.
- While your phone can be paired to multiple *Bluetooth* devices, each *Bluetooth* profile (phone and audio) can connect to only one device at a time.



**Entering the phone name**

You can enter a name for your phone so that it is easily identified by other devices when your phone is discoverable.



1. From the Home screen, tap  → **[Settings]**.
2. Tap **[Bluetooth]**.
3. Make sure that the phone's **[Bluetooth]** switch is turned on.
4. Tap  → **[Rename phone]**.
5. Enter the name and then tap **[Rename]**.

**Pairing the phone to another *Bluetooth* device**

Use this procedure if you want to use another *Bluetooth* device to initiate pairing of your phone and the other device, such as when pairing your phone to a *Bluetooth*-compatible car stereo.

1. From the Home screen, tap  → **[Settings]**.
2. Tap **[Bluetooth]**.
3. Make sure that the phone's **[Bluetooth]** switch is turned on.
4. Tap the phone's name.
  - The phone enters discoverable mode for 2 minutes by default. You can change this time by tapping  → **[Visibility timeout]**.
  - The amount of time before discoverable mode ends is displayed.
5. Operate the other device to pair the phone to the other device.
  - Refer to the operating instructions included with the other device for details.
6. Follow the on-screen instructions.

**Unpairing a *Bluetooth* device**

1. From the Home screen, tap  → **[Settings]**.
2. Tap **[Bluetooth]**.
3. Tap  next to the desired device.
4. Tap **[Unpair]**.

**Sending data to a *Bluetooth* device**

1. Using one of the apps on the phone, select the data you want to send.
2. Select the app's share or send option.
3. Select the *Bluetooth* option.

4. Select the destination device.
5. Operate the other device to accept the incoming file.
  - Refer to the operating instructions included with the other device for details.



### Note

- You can confirm the status of the data transfer in the notifications panel. If necessary, you can stop or retry the data transfer.

### Receiving data from a *Bluetooth* device

1. Send the data to your phone from the sending device.
  - Refer to the operating instructions included with the other device for details.
2. Open the phone's notifications panel and tap **[Bluetooth share: Incoming file]** → **[Accept]**.

### Note

- You can confirm the status of the data transfer in the notifications panel. If necessary, you can stop or retry the data transfer.
- To later view files you've received using your phone's *Bluetooth* feature, tap  in the Home screen and then tap **[Settings]** → **[Bluetooth]** →  → **[Show files received]**.

## Android Beam

---

Android Beam is a feature that allows you to share data, such as contacts, web page addresses, map locations, etc. with other Android Beam-compatible devices by simply touching your phone to the other device.

### Turning on the phone's Android Beam feature

1. From the Home screen, tap  → **[Settings]**.
2. Tap **[More...]**.
3. Turn on the **[NFC]** checkbox.
4. Tap **[Android Beam]** and then turn on the **[Android Beam]** switch.

### Sharing data using Android Beam

**To share your phone's data with another device:** First display the data on your phone that you would like to share, and then touch your phone and the other device together. When **[Touch to beam]** is displayed on your phone, tap the screen. The other device will receive and display the data.

**To use your phone to receive data from another device:** First display the data on the other device that you would like to share, and then touch your phone and the other device together. When **[Touch to beam]** is displayed on the other device, tap the screen. Your phone will receive and display the data.

### Note

- When touching your phone to the other device, make sure your phone's NFC antenna is placed near the other device's NFC antenna, and that both devices are unlocked.
- In order to use this feature, the other device must be compatible with Android Beam and its Android Beam feature must be turned on. Refer to the operating instructions included with the other device for details.

## USB connection features

---

You can use the included USB cable to connect your phone to your computer. This allows you to copy data between your phone and computer, which is useful for backing up data on your phone by saving it on your computer, or for using your phone as a portable data storage device.

You can also share your phone's mobile network connection with your computer via USB, which is known as "USB tethering". This allows you to use your computer to access the Internet, check email, download data, etc. even while away from home or the office where there is no Wi-Fi service.

### Copying data between your computer and the phone via USB

When you connect your phone to a computer via USB, the computer identifies your phone as a removable disk, allowing you to copy data between the two devices.

1. Use the included USB cable and connect the phone and computer.
2. Follow the on-screen instructions displayed on your phone and tap **[Turn on USB storage]** → **[OK]**.
  - Your phone will appear as an external disk to your computer.
3. Copy the desired files to the phone's USB storage.



#### Note

- While your phone's USB storage is available to be used by your computer as an external disk, apps that use the USB storage, such as the camera app, are unavailable.

#### IMPORTANT

- To safely disconnect your phone, return to the USB mass storage screen (tap the item in the notifications panel if necessary) and tap **[Turn off USB storage]**.
- Do not disconnect your phone from the computer while data is being transferred, otherwise data on your phone may become corrupted.

### Using USB tethering

1. From the Home screen, tap  → **[Settings]**.
2. Tap **[More...]** → **[Tethering & portable hotspot]**.
3. Turn on the **[USB tethering]** checkbox and then tap **[OK]**.
  - This option is only available when the phone is connected to your computer via USB.
  - Turn the **[USB tethering]** checkbox off when you are finished using the USB tethering feature.
  -  is displayed in the status bar when USB tethering is enabled.
  -  is displayed in the status bar when USB tethering and Wi-Fi hotspot (see "Configuring the phone as a Wi-Fi hotspot" (page 27)) are both enabled.

#### Note

- You cannot use USB tethering and access your phone's USB storage using a USB cable at the same time.
- Additional charges may be incurred when using this feature. Contact your mobile network operator for more information.
- This feature supports computers running Windows 7, Windows Vista, and Windows XP (Service Pack 3 or later), however, compatibility cannot be guaranteed.
- You may need to install drivers in your computer to be able to access the Internet when using USB tethering. Visit <http://panasonic.net/pmc/support/software/index.html> for the latest drivers.
- You may need to configure your computer to be able to access the Internet when using USB tethering. Visit <http://www.android.com/tether> for the latest information.

## DLNA (content streaming)

The **[DLNA]** app is a multimedia content streaming app that allows you to connect your phone wirelessly to other DLNA-compatible network devices. DLNA-compatible devices, including your phone, can be used to stream content to other DLNA-compatible devices and copy or transfer content from one device to another. This means you can enjoy your multimedia content even when it is stored on another device.

### Note

- Refer to the operating instructions for your DLNA-compatible device for more information.
- In order to use this feature, each device must be connected on the same network. Additionally, your phone must be connected to this network via Wi-Fi.

### Watching content stored on another device

1. Tap **[DLNA]** in the Home screen or app list.
2. Tap **[External content]**.
3. Select the desired device.
4. Browse for content and select the desired item.

### Selecting a device for uploading and streaming content

You can use your phone to copy content from your phone to another device, or to stream content from your phone to another device without copying it.

1. Tap **[DLNA]** in the Home screen or app list.
2. Tap **[Settings]**.
3. To set or change the destination device for uploading (copying) content:  
→ Tap the item displayed under **[UPLOAD TO]**.  
To set or change the destination device for streaming content:  
→ Tap the item displayed under **[EXTERNAL PLAYBACK DEVICE]**.
4. Select the desired device.

### Uploading or streaming content from the phone to another device

In order to use this feature, you must select a destination device (see “Selecting a device for uploading and streaming content” (page 70)).

1. Tap **[DLNA]** in the Home screen or app list.
2. Tap **[Local content]**.
3. Browse for the desired content.
4. Tap and hold the desired content and then drag it to **[Upload]** (for uploading) or **[Play from external device (DLNA)]** (for streaming).

### Using the phone as a media server

1. Tap **[DLNA]** in the Home screen or app list.
2. Tap **[Media server]**.
  - Once your phone’s media server is running, other DLNA-compatible devices can browse for and view content that is stored on your phone.
3. To stop the media server, tap .

# Synchronise, backup, and restore

Synchronisation and backup are two methods for making sure your data is stored in more than one location. Data in your phone can be synchronised or backed up using the following services and apps.

| Data type                    | Synchronisation service           |  | Backup method                        |                         |                                     |
|------------------------------|-----------------------------------|--|--------------------------------------|-------------------------|-------------------------------------|
|                              | Google Sync (for Google accounts) | Microsoft Exchange ActiveSync (for corporate accounts) | USB storage backup feature (page 72) | PC Backup app (page 73) | Manual copy to PC via USB (page 69) |
| Contacts                     | ✓                                 | ✓  | ✓                                    | –                       | ✓ <sup>*1</sup>                     |
| Email messages <sup>*2</sup> | ✓ <sup>*3</sup>                   | ✓ <sup>*4</sup>  | –                                    | –                       | –                                   |
| Calendar events              | ✓                                 | ✓  | –                                    | –                       | –                                   |
| Bookmarks                    | ✓                                 | –  | ✓                                    | –                       | ✓ <sup>*1</sup>                     |
| SMS messages                 | –                                 | –  | ✓                                    | –                       | ✓ <sup>*1</sup>                     |
| Pictures and videos          | –                                 | –  | –                                    | ✓                       | ✓ <sup>*5</sup>                     |
| Music                        | –                                 | –  | –                                    | –                       | ✓                                   |
| Apps                         | ✓ <sup>*6</sup>                   | –  | –                                    | –                       | –                                   |

<sup>\*1</sup> Use the USB storage backup feature to backup the data, and then manually copy the contents of the **[SD\_PIM]** folder in the phone's USB storage to your computer. To restore the data, copy it from your computer back to the **[SD\_PIM]** folder and then use the USB storage backup feature to restore the data.

<sup>\*2</sup> Email accounts that use the IMAP protocol can also be synchronised.

<sup>\*3</sup> Gmail accounts only.

<sup>\*4</sup> Microsoft Exchange ActiveSync email accounts only.

<sup>\*5</sup> Manually copy the contents of the **[DCIM]** folder in the phone's USB storage to your computer.

<sup>\*6</sup> Google's Play Store keeps a record of your previously purchased and downloaded apps. If you delete an app, you can download it again.

## Synchronising with your Google or Microsoft Exchange ActiveSync account

You can synchronise information on your phone with information associated with your Google account or your Microsoft Exchange ActiveSync account. This allows you to make sure that the latest emails, contacts, calendar events, and other information stored on your phone and other devices are up-to-date.

### Note



- To register your Google account, see “Registering your Google account” (page 17).
- To register your Microsoft Exchange ActiveSync account, see “Registering your Microsoft Exchange ActiveSync account” (page 18).

### Turning on synchronisation features

1. From the Home screen, tap  → **[Settings]**.

2. Tap **[Accounts & sync]**.
3. Turn on the **[Accounts & sync]** switch.
  - Turn off the switch to disable synchronisation for all accounts.
4. Select the desired account.
5. Turn on the checkbox for each item you would like to synchronise.

### Synchronising manually

1. From the Home screen, tap  → **[Settings]**.
2. Tap **[Accounts & sync]**.
3. Select the desired account.
4. Tap  → **[Sync now]**.

## Backing up to the USB storage

---

You can use the **[USB storage backup]** feature to back up the data on your phone, such as your contacts and SMS messages to a backup file that is stored in the phone's USB storage. You can use the backup file to later restore data to your phone, and you can delete backup files as necessary.

### Backing up data

1. From the Home screen, tap  → **[Settings]**.
2. Tap **[Backup & reset]** → **[USB storage backup]** → **[Back up to USB storage]**.
3. Enter the terminal password and tap **[OK]**.
4. Select the type of data that will be backed up and then tap **[Yes]**.
5. Tap **[OK]**.

#### **Note**

- Make sure the battery is charged before backing up data.

### Restoring backed up data

1. From the Home screen, tap  → **[Settings]**.
2. Tap **[Backup & reset]** → **[USB storage backup]** → **[Restore data to phone]**.
3. Enter the terminal password and tap **[OK]**.
4. Select the type of data that will be restored.
5. Select the desired option.
  - **[Replace]**: The backup data replaces the current data.
  - **[Add]**: The backup data is added to the current data.
6. Select the data that will be restored and then tap **[Yes]**.
7. Tap **[OK]**.

#### **Note**

- Make sure the battery is charged before restoring data.

### Deleting backed up data

1. From the Home screen, tap  → **[Settings]**.
2. Tap **[Backup & reset]** → **[USB storage backup]** → **[Delete backup data]**.
3. Enter the terminal password and tap **[OK]**.
4. Select the type of data that will be deleted.
5. Select the data that will be deleted and then tap **[Delete]**.
6. Tap **[Yes]** → **[OK]**.



## Backing up to a computer via Wi-Fi

If your phone and computer are connected to the same network using Wi-Fi, you can use the **[PC Backup]** app to back up the pictures and videos on your phone and save them on your computer.

### Configuring [PC Backup]

In order to make backups, you must first specify information about the computer including the computer name or network address, user name, password, and the name of the shared folder where the backups will be saved.

1. Tap **[PC Backup]** in the Home screen or app list.
2. Tap **☰ → [Settings]**.
  - This step is not necessary the first time you use this app, or if the configuration screen is already open.
3. Tap each item and enter the corresponding information about your computer.
  - You can also tap **[Settings wizard]** to search automatically for available computers and shared folders on the network.
4. Tap **[Connection test]** to confirm that the settings you made are correct.
  - If an error message is displayed, confirm the settings and try again.

### Backing up your data

1. Tap **[PC Backup]** in the Home screen or app list.
2. Press **↶** to display the list of backup options.
  - This step is not necessary if the list of backup options is already displayed.
3. Select the desired backup option and then tap **[OK]**.
  - **[All data]**: Backs up all pictures and videos.
  - **[Since last backup]**: Backs up all pictures and videos that were created or modified since the last backup.

## Backing up to a computer via USB

See “Copying data between your computer and the phone via USB” (page 69).

# Phone security

There are various ways you can lock your phone.

- **Locking the screen:** This prevents you from accidentally tapping your phone and operating it unintentionally. You can also lock the screen using a PIN, password, or other secure method to prevent unauthorised access to your phone. Once the screen is locked, it must be unlocked before your phone can be used. When the screen is unlocked, the user has access to the phone and most settings.
- **Hiding your data:** You can prevent unauthorised access to your important data by storing it in a virtual safe. You can also store entire email accounts in the safe, so that the accounts are not visible when the safe is closed.
- **Protecting phone settings:** You can set a terminal password (phone password) to prevent unauthorised access to certain phone settings. When the user attempts to change certain settings, the phone will ask the user to enter the terminal password.
- **Protecting your SIM card:** You can lock the SIM card to prevent unauthorised use of the card, even if it is removed and inserted into another phone. Once the SIM card is locked, it must be unlocked each time the phone is turned on. If the unlock code is entered incorrectly 3 times, it can only be unlocked with the operator-provided PUK (Personal Unblocking Key).

## Locking the screen

---

You can lock your screen to prevent unauthorised access to your phone.

### Configuring the screen lock

1. From the Home screen, tap  → **[Settings]**.
2. Tap **[Security]** → **[Screen lock]**.
3. Select the desired unlock method and then follow the on-screen instructions.

### Note

- Once a screen unlock method is selected, you must use that unlock method to unlock the screen (such as when pressing  to activate the screen) and also to change the screen lock setting.
- If you try to unlock the screen five times unsuccessfully, you must wait 30 seconds before you can try to unlock the screen again. If you cannot remember the unlock pattern, and if you have a Google account registered to the phone, you can unlock the screen by tapping **[Forgotten pattern?]** and entering your Google account information. (This method is not available for forgotten PINs and passwords.)
- If you select a PIN, password, or other secure method as the unlock method, you can make emergency calls from the lock screen by tapping **[Emergency call]**. In this case there is no need to unlock the screen.
- Refer to the information found in “Phone does not recognise my NFC card (NFC tag)” (page 87) when registering and using NFC cards.

### Changing the screen lock

1. From the Home screen, tap  → **[Settings]**.
2. Tap **[Security]** → **[Screen lock]**.
3. Enter the correct unlock pattern if necessary.
4. Select the desired unlock method and then follow the on-screen instructions.

## Hiding your data

---

You can store important information, such as documents, pictures, videos, and email accounts in a virtual “safe” on your phone, where they are protected from unauthorised access. Information stored in the safe

cannot be seen while the safe is closed. A PIN, password, or other secure unlock method is required to open the safe. Once you open the safe, it will close automatically when the screen locks.

### Configuring the data security feature for the first time

1. Tap **[Data Security]** in the Home screen or app list.
2. Tap **[Change settings now]**.
3. Select the desired unlock method and then follow the on-screen instructions to set the unlock pattern.
  - When finished, the safe will be open. You can close the safe by tapping **[Lock]**.

### Opening the safe

1. Tap **[Data Security]** in the Home screen or app list.
2. Enter the correct unlock pattern.
  - All files in the safe will be visible.
  - If you cannot remember the unlock pattern, you can use your Google account information to reset the unlock pattern. If you try to open the safe five times unsuccessfully, you will be prompted to enter your Google account information.

#### **Note**

- Refer to the information found in “Phone does not recognise my NFC card (NFC tag)” (page 87) when registering and using NFC cards.

### Closing the safe

1. Tap **[Data Security]** in the Home screen or app list.
  - If you are prompted to unlock the phone, the safe is already closed.
2. Tap **[Lock]**.
  - The safe also closes automatically when the screen locks.

### Adding a file to the safe

1. While using an app that is compatible with this feature, select the desired file.
2. Use the app’s share option and select **[Security Box]** as the share destination.
  - If the safe is closed, enter the correct unlock pattern.
  - This procedure varies depending on the app being used.
3. Tap **[Store]**.
  - The file will now be visible only when the safe is open.
  - To remove a file from the safe, repeat this procedure and tap **[Remove]**.

### Adding an email account to the safe

You can add an email account to the safe by creating the account while the safe is open. This account can only be accessed when the safe is open.

1. Tap **[Data Security]** in the Home screen or app list.
  - If the safe is closed, enter the correct unlock pattern.
2. Tap **[Use Secure Email]**.
3. Create a new email account.

#### **Note**

- To use an email account that is stored in the safe, open the safe and tap **[Use Secure Email]**, or open the **[Email]** app while the safe is open.

### Deleting data in the safe

1. Tap **[Data Security]** in the Home screen or app list.
  - If the safe is closed, enter the correct unlock pattern.

2. Tap **[Delete]**.
3. Select the desired option and then tap **[OK]**.

## Protecting phone settings with a terminal password

---

A terminal password (phone password) is required when changing certain settings.

### Configuring the terminal password

1. From the Home screen, tap  → **[Settings]**.
2. Tap **[Security]** → **[Terminal password setting]**.
  - If the terminal password has already been set, you will be prompted to enter the current terminal password.
3. Enter the desired terminal password and then tap **[OK]**.
4. Enter the desired terminal password again and then tap **[OK]**.

## Protecting your SIM card

---

You can lock the SIM card to prevent unauthorised use of the card, even if it is removed and inserted into another phone. Once the SIM card is locked, it must be unlocked each time the phone is turned on. If the unlock code is entered incorrectly 3 times, it can only be unlocked with the operator-provided PUK (Personal Unblocking Key).

### Locking the SIM card

1. From the Home screen, tap  → **[Settings]**.
2. Tap **[Security]** → **[Set up SIM card lock]**.
3. Turn on the **[Lock SIM card]** checkbox.
4. Enter the current SIM PIN and tap **[OK]**.

### Changing the SIM PIN

1. From the Home screen, tap  → **[Settings]**.
2. Tap **[Security]** → **[Set up SIM card lock]**.
3. Tap **[Change SIM PIN]**.
  - This option is only available if the SIM card is already locked.
4. Enter the current PIN and tap **[OK]**.
5. Enter the desired PIN and tap **[OK]**.
6. Enter the desired PIN again and tap **[OK]**.

# Updating the phone

You can update the software in your phone to take advantage of software improvements and new features.

## Note

- Fully charge the battery before updating the phone.
- We recommend connecting the phone to a power source while updating.
- Back up all necessary data before updating the phone. Certain types of data, such as downloaded data, will not be retained after updating the phone.
- Certain settings will be reverted to the factory default values after the phone is updated. Configure these settings again as necessary.
- The phone cannot be used while updating. All apps and features, including making or receiving calls, using communication features, etc., will be unavailable.
- You cannot update the phone in the following situations:
  - When you are on a call
  - When aeroplane mode is turned on (“Turning aeroplane mode on and off” (page 19))
  - When tethering is turned on (“Configuring the phone as a Wi-Fi hotspot” (page 27), “Using USB tethering” (page 69))
  - When the date and time settings are incorrect (“Setting the date and time” (page 18))
  - When the battery level is not sufficient for software update
- Some third-party apps may not function properly after the phone is updated.
- Once the phone has been updated, you cannot revert to an older version of the software.
- If an error occurs while updating the phone, contact your regional Panasonic representative. (Contact information can be found on the included Warranty Card.)

## Downloading updates wirelessly

When software updates have been released for your phone, you can download them wirelessly.

## Note

- This feature requires an Internet connection.
- To avoid additional data transmission charges, we recommend using a Wi-Fi connection to download updates.

### Checking for updates automatically

1. From the Home screen, tap  → **[Settings]**.
2. Tap **[About phone]** → **[Software update]** → **[Update from server]** → **[Settings]**.
3. Turn the **[Auto search]** checkbox on or off.
  - When the checkbox is turned on, the phone will connect to the network automatically at the preset time and search for updates. When the checkbox is turned off, the phone will not search for updates automatically.
4. Tap **[OK]**.

### Checking for updates immediately

1. From the Home screen, tap  → **[Settings]**.
2. Tap **[About phone]** → **[Software update]** → **[Update from server]** → **[Software update]**.
3. Tap **[Yes]** to check for updates immediately.
  - Tap **[No]** to cancel.
  - Information about any available updates is displayed.
4. Follow the on-screen instructions.

### Downloading updates with a computer

---

If software updates for your phone are available on the Panasonic web site, you can use your computer to download them and copy them to the phone. You can then use the following procedure to update the software manually.

Before using this procedure, make sure you have copied the update file to the [Download] folder in the phone's USB storage.

1. From the Home screen, tap  → **[Settings]**.
2. Tap **[About phone]** → **[Software update]** → **[Update from USB storage]** → **[OK]**.
3. Follow the on-screen instructions.

# Phone settings overview



























You can customise general phone settings to suit your needs using the **[Settings]** app. Settings are grouped into the categories explained below.

| Settings category             | Description   |
|-------------------------------|---|
| <b>[Wi-Fi]</b>                | Contains wireless network settings.   |
| <b>[Bluetooth]</b>            | Contains <i>Bluetooth</i> wireless technology settings.   |
| <b>[Data usage]</b>           | Contains settings related to network usage.   |
| <b>[Call settings]</b>        | Contains phone call related settings such as voicemail, call forwarding, and call waiting.  |
| <b>[More...]</b>              | Contains settings related to wireless networks, such as aeroplane mode, NFC, Wi-Fi Direct, and Android Beam.  |
| <b>[Sound]</b>                | Contains settings related to volume and silent mode, vibration, and ringtones.  |
| <b>[Display]</b>              | Contains settings such as brightness and screen timeout.  |
| <b>[Storage]</b>              | Allows you to confirm the available space in your phone.  |
| <b>[Battery]</b>              | Allows you to confirm and manage battery performance.   |
| <b>[Apps]</b>                 | Allows you to manage and remove the apps installed on your phone.   |
| <b>[Accounts &amp; sync]</b>  | Allows you to add and remove new accounts, as well as manage how your phone synchronises to servers to keep its data up-to-date.  |
| <b>[Location services]</b>    | Contains settings related to how your phone uses location information.  |
| <b>[Security]</b>             | Contains settings that control security-related features such as screen lock and SIM lock.  |
| <b>[Language &amp; input]</b> | Contains settings related to display language, input language, the keyboard, speech, and the user dictionary.   |
| <b>[Backup &amp; reset]</b>   | Contains data backup and deletion related settings that help you manage and back up your personal information to Google servers. You can also reset your phone and its information using settings found here. |
| <b>[Memory refresh]</b>       | Contains settings that allow you to refresh the phone's memory at a specified time.   |
| <b>[Date &amp; time]</b>      | Contains settings that determine your phone's date, time, time zone, and time format.   |
| <b>[Accessibility]</b>        | Contains settings that can make the phone easier to interact with.  |
| <b>[Developer options]</b>    | Contains advanced settings that are not required for typical use.   |
| <b>[About phone]</b>          | Allows you to configure system update settings and confirm general phone information such as battery level, network status, and installed software versions.  |





# List of icons

Icons may vary by region and mobile network service operator.























## Notification icons

-  New Gmail received
-  New email message received
-  New SMS message received
-  Error when sending SMS message
-  New voicemail received
-  New instant message received
-  Calendar event reminder
-  Song is being played
-  Open (unsecured) wireless network is available
-  File received via *Bluetooth* feature
-  VPN connected
-  PC is connected via USB
-  USB tethering enabled
-  Wi-Fi hotspot or Wi-Fi Direct enabled
-  USB tethering and Wi-Fi hotspot enabled
-  Error message
-  Call in progress
-  Missed call
-  Call is on hold
-  Uploading data
-  Downloading data
-  App installation complete
-  App updates available from Play Store
-  More notifications available
-  Screenshot saved
-  eco mode is on



-  Panasonic Smartphone Site update notification
-  Safe was opened
-  GPS is activated
-  Temperature error
-  Charging error

### Status icons

-  Mobile network is available
-  No mobile network is available
-  Roaming on another mobile network
-  HSPA network is available
-  HSPA network is in use
-  3G network is available
-  3G network is in use
-  EDGE network is available
-  EDGE network is in use
-  GPRS network is available
-  GPRS network is in use
-  Aeroplane mode is on
-  Connected to Wi-Fi network
-  *Bluetooth* feature is on
-  *Bluetooth* device is connected
-  SIM card is not inserted
-  Alarm is set
-  Speakerphone is on
-  Microphone is muted
-  Silent mode is on
-  Vibrate mode is on
-  Battery is charging

## App icons

Preinstalled apps may vary by region.



**Phone**  
Phone calls



**People**  
Address book



**Messaging**  
Text messaging



**Gmail**  
Email client for Gmail accounts



**Email**  
Email client



**Browser**  
Internet browser



**Camera**  
Picture and video capture



**Picture Album**  
Picture and video viewing



**Play Music**  
Music playback



**DLNA**  
Multimedia streaming



**YouTube**  
Video sharing

















**Maps**  
Maps and local information



**Navigation**  
Directions

---

|   |  |
|---|--|
|    | <b>Local</b><br>Location-based places of interest              |
|    | <b>Facebook</b><br>Social network                              |
|    | <b>Twitter</b><br>Social media                                 |
|    | <b>Talk</b><br>Instant messaging                               |
|    | <b>Play Store</b><br>Software purchase and download            |
|   | <b>Calculator</b><br>Calculator                                |
|  | <b>PC Backup</b><br>Data backup                                |
|  | <b>Settings</b><br>General device configuration                |
|  | <b>NFC Starter</b><br>NFC tag utility                          |
|  | <b>Task viewer</b><br>App management                           |
|  | <b>Panasonic Smartphone Site</b><br>Link to Panasonic web site |
|  | <b>Calendar</b><br>Appointment management                      |
|  | <b>Notepad</b><br>Text memos                                   |
|  | <b>Polaris Office</b><br>Office apps                           |

# Troubleshooting

## Basic troubleshooting

If you experience any difficulty with the phone, try to resolve the problem by performing the following troubleshooting tips. Perform each operation one by one until the problem is resolved.

- Turn the phone off and then on again.
- Turn the phone off, remove and re-insert the SIM card, and then turn the phone on again.
- Update the phone. See page “Updating the phone” (page 77) for more information.
- If a dialogue is displayed that prompts you to force an app to stop, force the app to stop.
- Disconnect the USB cable from the phone and then press and hold  for about 20 seconds. The phone will turn off, and then turn on again. If it does not turn on again automatically, turn the phone on manually. You may need to charge the battery before the phone can be turned on again.
- Reset the phone.

## Resetting the phone

1. From the Home screen, tap  → **[Settings]**.
2. Tap **[Backup & reset]** → **[Factory data reset]**.
3. Enter the terminal password if prompted and then tap **[OK]**.
  - If you want to delete the contents of the USB storage also, turn on the **[Erase USB storage]** checkbox.
4. Tap **[Reset phone]** → **[Erase everything]**.

### **IMPORTANT**

- All personal information and downloaded apps will be deleted if you reset the phone. Back up any important data stored on the phone before resetting it.

## Power and battery issues

| Problem                               | Cause and/or solution  |
|---------------------------------------|--|
| Cannot turn the phone on              | <ul style="list-style-type: none"> <li>• Make sure the battery is adequately charged.</li> </ul>   |
| Battery does not charge               | <ul style="list-style-type: none"> <li>• The AC adaptor or USB cable is not connected to the phone or to the power source correctly. Check all connections.</li> <li>• If using a computer to charge the phone, make sure the computer is turned on and is sending power through the USB cable.</li> </ul> |
| Battery charging icon does not appear | <ul style="list-style-type: none"> <li>• It may take a few minutes before the battery icon appears when the phone starts charging.</li> </ul>  |

| Problem                             | Cause and/or solution  |
|-------------------------------------|--|
| Battery performance is poor         | <ul style="list-style-type: none"> <li>• Try using eco mode to save battery power. See “eco mode” (page 21).</li> <li>• Check all connections and charge the battery again.</li> <li>• Ambient temperature is too hot or too cold.</li> <li>• If the phone is out of range of a mobile network, the phone continuously searches for an available mobile network and therefore consumes more battery power.</li> <li>• Battery performance varies by usage conditions and degrades over time.</li> <li>• The battery is a consumable item. If the amount of time the phone can be used becomes dramatically shorter and repeated recharging does not restore the battery’s performance, contact an authorised service centre and request that your phone’s battery be replaced with a new one.</li> </ul> |
| Temperature error icon is displayed | <ul style="list-style-type: none"> <li>• If you use the phone for an extended period of time while charging it, the phone can become hot. Disconnect the phone from the AC adaptor or power source and allow it to cool down before charging it again. Features displayed in the notifications panel cannot be used while the temperature error icon is displayed.</li> </ul>  |
| “Charging error” icon is displayed  | <ul style="list-style-type: none"> <li>• Open the notifications panel and follow the on-screen instructions for solving the problem.</li> </ul>  |

Phone call issues

| Problem                       | Cause and/or solution   |
|-------------------------------|---|
| Cannot make or receive calls  | <ul style="list-style-type: none"> <li>• Make sure aeroplane mode is turned off. See “Turning aeroplane mode on and off” (page 19).</li> <li>• Reception may be poor in the current location. Move to another area and try again.</li> <li>• Remove and reinsert the SIM card. Make sure the SIM card is inserted properly.</li> <li>• Confirm that the phone is connected to the correct network. See “Selecting a specific network manually” (page 24).</li> <li>• You may have enabled calling features such as call forwarding or fixed dialling that are preventing the phone from making/receiving calls. See “Turning call forwarding on” (page 32) or “Turning fixed dialling on and off” (page 33).</li> </ul> |
| Calls are being dropped       | <ul style="list-style-type: none"> <li>• The signal may be weak or reception may be poor. Move to another area and try again.</li> </ul>  |
| Cannot make calls to contacts | <ul style="list-style-type: none"> <li>• Make sure you have entered the correct phone number for the contact.</li> </ul>  |
| Can only make emergency calls | <ul style="list-style-type: none"> <li>• Confirm that the SIM card is inserted properly.</li> <li>• Confirm that the phone is connected to the correct network. See “Selecting a specific network manually” (page 24).</li> </ul>   |

## Troubleshooting

---

| Problem                            | Cause and/or solution  |
|------------------------------------|--|
| Other party cannot hear your voice | <ul style="list-style-type: none"><li>• Make sure you are not covering the microphone.</li><li>• Make sure that you are speaking into the microphone and that the microphone is not too far from your mouth.</li><li>• If you are using a headset, make sure the headset is connected properly.</li><li>• Reception may be poor in the current location. Move to another area and try again.</li></ul> |

### SIM card issues



| Problem                         | Cause and/or solution   |
|---------------------------------|---|
| "No SIM card" icon is displayed | <ul style="list-style-type: none"><li>• Make sure the SIM card is inserted properly.</li></ul>  |
| SIM card is locked              | <ul style="list-style-type: none"><li>• If you have enabled the SIM lock feature, the SIM card must be unlocked each time your phone is turned on. See "Locking the SIM card" (page 76).</li><li>• If the unlock code is entered incorrectly 3 times, it becomes PUK-locked and can only be unlocked with the operator-provided PUK (Personal Unblocking Key). Contact your mobile network operator for more information.</li></ul> |
| SIM card is PUK-locked          | <ul style="list-style-type: none"><li>• Once the SIM card is PUK-locked, it can only be unlocked with the operator-provided PUK (Personal Unblocking Key). If the PUK is entered incorrectly 10 times, the SIM card can no longer be used and you must replace the SIM card. Contact your mobile network operator for more information.</li></ul>   |

### Connectivity issues

| Problem   | Cause and/or solution  |
|---|--|
| Cannot connect to the Internet when travelling, away from home, etc.                                  | <ul style="list-style-type: none"><li>• Use the phone's Wi-Fi feature to connect to a Wi-Fi network. See "Connecting to a Wi-Fi network" (page 25).</li><li>• To access the Internet by using a mobile network while roaming, make sure that <b>[Data roaming]</b> is turned on. See "Enabling data roaming" (page 25). Note that data transmission charges may apply.</li></ul>   |
| Cannot use Internet-based services  | <ul style="list-style-type: none"><li>• Make sure that the Internet and network settings in your phone are correct. See "Connecting to mobile networks" (page 24).</li></ul>   |
| Connectivity using <i>Bluetooth</i> wireless technology, Android Beam, or Wi-Fi Direct is not working | <ul style="list-style-type: none"><li>• Make sure the other device supports the feature you are trying to use, and that the corresponding feature of both devices is turned on.</li><li>• Move the devices closer to each other and try again.</li><li>• When using Android Beam, the two devices should be touching or nearly touching.</li><li>• Refer to the operating instructions included with the other device for proper operation and troubleshooting tips.</li></ul> |

| Problem  | Cause and/or solution  |
|--|--|
| Phone does not recognise my NFC card (NFC tag) | <ul style="list-style-type: none"> <li>• The phone cannot register or detect NFC cards if the phone's NFC feature is turned off. To confirm the setting, tap  in the Home screen and then tap <b>[Settings]</b> → <b>[More...]</b>, and then make sure the <b>[NFC]</b> checkbox is turned on.</li> <li>• An NFC card registered for use with the screen lock feature cannot be registered for use with <b>[NFC Starter]</b>, and vice versa.</li> <li>• Certain NFC cards may not be able to be registered.</li> </ul> |

Other issues

| Problem   | Cause and/or solution  |
|---|--|
| Screen is too dark                              | <ul style="list-style-type: none"> <li>• Adjust the screen brightness setting. See “Adjusting the screen brightness manually” (page 19).</li> <li>• If eco mode is enabled, either adjust the eco mode setting for automatically dimming the screen or charge the battery. See “Changing the eco mode settings” (page 21).</li> </ul>  |
| Forgot how to unlock the screen                 | <ul style="list-style-type: none"> <li>• If you forgot the unlock pattern, and if you have a Google account registered to the phone, you can unlock the screen by tapping <b>[Forgotten pattern?]</b> and entering your Google account information.</li> <li>• If you forgot the PIN or password, contact your regional Panasonic service centre.</li> </ul>   |
| Phone is hot during use or when charging        | <ul style="list-style-type: none"> <li>• When you use apps that require a large amount power or when you use the phone for an extended period of time while charging it, the phone may feel hot to the touch. This is normal and should not affect the phone's life span or performance.</li> </ul>  |
| Touch panel screen does not turn on as expected | <ul style="list-style-type: none"> <li>• Press  (power) or tap and hold .</li> <li>• A foreign object is interfering with the proximity sensor. Remove any protective covers from the screen that may be interfering with the touch panel screen's functionality.</li> </ul> |
| Cannot open or receive a file                   | <ul style="list-style-type: none"> <li>• The phone does not support the file type, or there is not enough available memory to receive the file.</li> </ul>   |
| Cannot play certain songs                       | <ul style="list-style-type: none"> <li>• Confirm that the file type is supported by the phone.</li> </ul>  |
| No sound is heard                               | <ul style="list-style-type: none"> <li>• Confirm that silent mode is turned off. See “Turning silent mode on and off” (page 20).</li> <li>• Confirm that the volume is turned up.</li> </ul>   |
| Camera pictures and videos are blurry           | <ul style="list-style-type: none"> <li>• Make sure the camera lens is clean and not smudged.</li> <li>• When taking pictures of people, set the focus mode to <b>[Face]</b> (see “[Focus Mode]” (page 51)) or set the <b>[Scene]</b> mode to <b>[Portrait]</b> (see “[Shooting Mode]” (page 51)).</li> <li>• Set the shooting mode to <b>[Stabilization]</b> (see “[Shooting Mode]” (page 51)).</li> </ul>   |

## Need help?

If you experience any problems with your phone, there are several ways that we can be of assistance.

### **Troubleshooting**

Refer to the Troubleshooting section of this document for assistance in solving any problems you might be having with your phone.

### **Support on the web**

Visit the support web site at [http://www.panasonic.eu/customer\\_service.html](http://www.panasonic.eu/customer_service.html) for the latest support information, software downloads, FAQs, and more.



# Index

## A

AC adaptor 6  
Aeroplane mode 19  
Android Beam 68

## B

Backup 72, 73  
Battery  
  Charging 6  
  Saving power 7  
Bluetooth wireless technology  
  Pairing 66, 67  
  Receiving data 68  
  Sending contacts 34  
  Sending data 67  
  Unpairing 67  
Brightness 19  
Browser 43  
  Bookmarks 44  
  Downloading 45  
  Settings 45

## C

Calendar 59  
Call forwarding 32  
Call log 31  
Call waiting 32  
Caller ID 33  
Calling features  
  International calls 29  
  Rejecting a call 32  
Camera 49  
Charging 6  
Computer  
  Connection 7  
  Copying audio files to the phone 47  
  Downloading software updates 78  
Conference calls 32  
Contacts 31, 34  
  Add yourself 35  
  Adding contacts 34  
  Adding email sender 38  
  Adding text sender 41  
  Backing up 36  
  Deleting 35  
  Editing 35  
  Importing 34  
  Sharing 36  
  Syncing 34  
Control panel 14

## D

Data Security 74  
Date & time 18  
DLNA 69

## E

Earpiece volume 30  
eco mode 21  
Email 37  
  Accounts 39  
  Composing 37  
  Default account 39  
  Deleting 38  
  File attachments 37  
  Forwarding 38  
  Reading 37  
  Removing account 39  
  Replying 38  
  Searching 39  
  Sending 37  
Emergency calls 29  
Entering text 15

## F

Fixed dialling numbers 33  
Folders 13

## G

Gmail 39  
GPS 56

## H

Headset 22, 30  
Home screen 12  
  Folders 13  
  Wallpaper 13  
  Web page shortcut 45  
  Widgets 13

## I

Icons  
  App icons 82  
  Notification icons 80  
  Status icons 81

## K

Keyboard 15  
  Voice recognition 17

## L

Language 16, 19  
Local 58

## M

Maps 56  
Memory 22  
Messaging 40  
  Calling sender 41  
  Composing 40  
  Deleting 40  
  File attachments 41  
  Forwarding 40

## Index

---

- Replying 40
- Searching 41
- Settings 41
- Microphone 22, 30
- Missed calls 31
- Mobile networks 24
- Music 47
  - Copying audio files to the phone 47
  - Listening 47
  - Playlists 48
- Mute 30

## N

- Navigation 57
- Navigation buttons 10
- NFC card 59
- NFC Starter 59
- Notepad 61
- Notifications panel 14

## P

- Parts of phone 9
- People 34
- Phone 29
  - Answering calls 30
  - Call forwarding 32
  - Call log 31
  - Call waiting 32
  - Caller ID 33
  - Conference calls 32
  - Emergency calls 29
  - Fixed dialling numbers 33
  - Making calls 29
  - Voicemail 31
- Phone security 74
- Picture Album 53
- Picture album 54
- Pictures 49, 53
  - Editing 54
  - Sharing 54
  - Viewing on a map 54
- Play Music 47
- Play Store 64
- Power on/off 7

## R

- Recording videos 50
- Restore 72
- Ringtone 20

## S

- Screen
  - Gestures 10
  - Unlock 8
  - Vertical and horizontal viewing 12
- Screen lock 74
- Screen timeout 19
- Security 74
- Settings 79
  - Aeroplane mode 19

- Brightness 19
- Browser 45
- Call forwarding 32
- Call waiting 32
- Camera 51, 53
- Data roaming 25
- Data usage limit 24
- Date & time 18
- Dialling touch tones 20
- Disabling network data connection 24
- First time 8
- General 18
- GPS 56
- Input language 16
- Internet 24
- Messaging 41
- Ringtone 20
- Screen language 19
- Screen timeout 19
- Sound 20
- Static IP address 26
- Synchronisation 71
- Time format 19
- Time zone 19
- Vibrate mode 20
- Voicemail 32
- Volume 20
- VPN 28
- Wi-Fi 25
- Silent mode 20, 30
- SIM card
  - Importing from 34
  - Inserting 6
  - Locking 76
  - Removing 6
- Slideshow 54
- Software update 77
- Speaker volume 30
- Speakerphone 30
- Static IP 26
- Status bar 14
- Storage 22
- Synchronising 71

## T

- Taking pictures 49
- Talk 42
- Terminal password 76
- Time zone 19
- Troubleshooting 84
- Typing 15

## U

- Update software 77
- Uploading videos 63
- USB cable 6, 7
- USB connection 69
- USB storage
  - Importing from 34
- USB tethering 69

**V**

- Vibrate 20
- Videos 50, 53
  - Sharing 54
- Voice recognition 17
- Voicemail 31
  - Playing messages 31
  - Settings 32
- Volume 20, 30
- VPN 28

**W**

- Wallpaper 13
- Web browser 43
- Widgets 13
- Wi-Fi 25
- Wi-Fi Direct 27
- Wi-Fi hotspot 27

**Y**

- YouTube 62

**Panasonic Mobile Communications Co., Ltd.**

600 Saedo-cho, Tsuzuki-ku, Yokohama-city, Kanagawa 224-8539 Japan

**<http://panasonic.net/>**

**Copyright:**

This material is copyrighted by Panasonic Mobile Communications Co., Ltd., and may be reproduced for internal use only. All other reproduction, in whole or in part, is prohibited without the written consent of Panasonic Mobile Communications Co., Ltd.

© Panasonic Mobile Communications Co., Ltd. 2012