

Panasonic®

EB-X70

Operating Instructions

Digital Cellular Phone

X70

Bluetooth®

ESN®



Contents

Safety first	5
Care and maintenance	11
Overview of features	13
SIM and battery	14
Quick start	17
Your phone	22
Display icons	23
Menu structure	25
Voice calls	27
Text entry	35
Settings	38
Contacts list	57
Games	66
Browser	68
Camera	73
Messaging	80
Data folders	100
Organiser	111
Connect	121
Accessories	130
Troubleshooting	133
Glossary	137
Consumer update	139

Contents

Specifications	144
Warranty	146
Licensing	148
Personal settings and notes ...	149
Index	152

Safety first

Your new phone is a convenient and effective communications tool, but it can be hazardous when used improperly. To avoid harming yourself or anyone else, please review the following information before using your phone.

Batteries

Batteries can cause property damage, injury, or burns if the terminals are touched with a conductive material (for example, metal jewellery, keys, and so on). Therefore, use caution when handling a charged battery. Additional precautions and notes are listed below:

- Never throw a battery into a fire; it may explode.
- Fully recharge the battery if the battery is low or as soon as the low-battery alert beeps.
- Do not drop the battery.
- Do not allow bridging of battery contacts with metallic objects.
- Do not remove the battery from the phone while the phone is powered on. Settings you have changed may revert to their previous settings.



A recyclable lithium ion/polymer battery powers your phone. Please call 1-800-8-BATTERY for information on how to recycle the battery.

Charging devices

Use only Genuine Panasonic charging accessories. Use of attachments not recommended by Panasonic or your Service Provider may result in fire, electrical shock, or injury. Panasonic is not responsible for damage caused by using non-Panasonic accessories.

- Do not expose charging adapters to moisture, water, or the weather.
- Do not use an adapter with a damaged cord.
- When using a DC adapter in an automobile, a small amount of electricity flows through the adapter, even if the phone is turned off. Remove the plug from the cigarette lighter whenever the phone will be left in the vehicle for long periods of time.
- Always charge the battery in a well ventilated area, not in direct sunlight, between 41°F (5°C) and 95°F (35°C). It is not possible to recharge the battery if it is outside this temperature range.
- Do not incinerate or dispose of the battery as ordinary trash. The battery must be disposed of in accordance with local legislation and may be recycled.

Caution: The cigarette lighter must have a 12V negative ground socket. Do not use the adapter in a vehicle that has a positive ground system.

General

- Do not use the phone in extreme temperature or humidity. The specified operating temperature range is -22°F to +140°F (-30°C to +60°C).
- Extreme temperatures may have a temporary effect on the operation of your phone. This is normal and does not indicate a fault.
- Do not expose the phone (particularly the display) to direct sunlight for extended periods of time or to a humid, dusty or hot area.
- Do not attempt to disassemble the phone. There are no user-serviceable parts inside.

Safety first

- Do not subject the equipment to excessive vibration or shock.
- Do not expose the phone to rain or spill liquids on it. If the equipment becomes wet immediately remove the battery and charging device and contact your dealer.
- Do not carry the phone by holding the antenna.
- Do not use any accessories other than those designed for use with your phone.
- Use of attachments not recommended or sold by Panasonic or your Service Provider may result in fire, electrical shock, or injury.
- Panasonic is not responsible for damages caused by using non-Panasonic accessories.
- Pressing any of the keys may produce a loud tone. Avoid holding the phone close to the ear while pressing the keys.
- Keep metallic items that may accidentally touch the battery terminals away from the equipment. Battery damage may occur.
- When disposing of any packing materials or old equipment check with your local authorities for information on recycling.
- If connecting the phone to an external source, read the operating instructions of the equipment for the correct connection and safety precautions.
- If connecting the phone to an external source, verify that the phone is compatible with the product to which you are connecting it.

Availability of service

This phone, like any wireless phone, operates using radio signals, wireless and landline networks, and user-programmed functions. Because of this, connection in all conditions cannot be guaranteed. Therefore, you should never rely solely on any wireless phone for essential communications (for example, medical emergencies).

Emergency (911) service

If you need to make an emergency (911) call, power the phone on, dial 911, and press . Emergency calls can be made regardless of lock setting and with or without a SIM card. Remember, to make or receive any call, the phone must be switched on and in a service area that has adequate signal strength. Even if you are within the coverage area of your Service Provider, you may be in an area with insufficient signal strength to place a 911 call. Emergency calls might not be possible on all wireless phone networks or when certain network service and/or phone features are in use.

Safety tips

Following the suggestions in this section will help ensure safe and efficient operation of your Panasonic phone.

This Model Phone Meets The Government's Requirements For Exposure To Radio Waves.

Your wireless phone is a radio transmitter and receiver. It is designed and manufactured not to exceed the emission limits for exposure to radiofrequency (RF) energy set by the Federal Communications Commission of the U.S. Government. These limits are part of comprehensive guidelines and establish permitted levels of RF energy for the general population. The guidelines are based on standards that were developed by independent scientific organizations through periodic and thorough evaluation of scientific studies. The standards include a substantial safety margin designed to assure the safety of all persons, regardless of age and health.

The exposure standard for wireless mobile phones employs a unit of measurement known as the Specific Absorption Rate, or SAR. The SAR limit set by the FCC is 1.6W/kg. Tests for SAR are conducted using standard operating positions specified by the FCC with the phone transmitting at its highest certified power level in all tested frequency bands.

Although the SAR is determined at the highest certified power level, the actual SAR level of the phone while operating can be well below the maximum value. This is because the phone is designed to operate at multiple power levels so as to use only the power required to reach the network. In general, the closer you are to a wireless base station antenna, the lower the power output.

Before a phone model is available for sale to the public, it must be tested and certified to the FCC that it does not exceed the limit established by the government-adopted requirement for safe exposure. The tests are performed in positions and locations (e.g., at the ear and worn on the body) as required by the FCC for each model. The highest SAR value for this model phone when tested for use at the ear is 0.626 W/kg. While there may be differences between the SAR levels of various phones and at various positions, they all meet the government requirement for safe exposure.

The FCC has granted an Equipment Authorization for this model phone with all reported SAR levels evaluated as in compliance with the FCC RF emission guidelines. SAR information on this model phone is on file with the FCC and can be found under the Display Grant section of <http://www.fcc.gov/oet/fccid> after searching on FCC ID NWJ22B001A.

Additional information on Specific Absorption Rates (SAR) can be found on the Cellular Telecommunications Industry Association (CTIA) web-site at <http://www.wow-com.com>.

Caution: All Panasonic branded accessories are tested and comply with FCC RF exposure requirements. Non-Panasonic accessories may not comply.

Antenna care

Do not use the phone with a damaged antenna. Use only the supplied or an approved replacement antenna. Unauthorized antennas, modifications, or attachments could damage the phone and may violate FCC regulations.

Phone operation

Normal Position: Hold the phone as you would any other telephone, with the antenna pointed up and over your shoulder.

For Efficient Operation: For your phone to operate most efficiently, do not touch the antenna unnecessarily when the phone is in use. Contact with the antenna affects call quality and may cause the phone to operate at a higher power level than otherwise needed.

Driving

Important: Check the laws and regulations on the use of wireless telephones in the areas where you drive. Always obey them. Also, if using your phone while driving:

- Give full attention to driving - driving safely is your first responsibility;
- Use handsfree operation, if available;
- Pull off the road and park before making or answering a call if driving conditions so require.

Electronic devices

Most modern electronic equipment is shielded from RF signals. However, certain electronic equipment may not be shielded against the RF signals from your wireless phone.

Pacemakers: The Health Industry Manufacturers Association recommends that a minimum separation of 6 inches (6") or 15 centimeters (15 cm) be maintained between a handheld wireless phone and a pacemaker to avoid potential interference with the pacemaker. These recommendations are consistent with independent research and recommendations of Wireless Technology Research.

Persons with pacemakers:

- Should ALWAYS keep the phone more than six inches from their pacemaker when the phone is turned ON;
- Should not carry the phone in a breast pocket;
- Should use the ear opposite the pacemaker to minimize the potential for interference;
- If you have any reason to suspect that interference is taking place, turn your phone OFF immediately.

Hearing Aids: Some digital wireless phones may interfere with some hearing aids. In the event of such interference, consult your Service Provider and hearing aid manufacturer.

Other Medical Devices: If you use any other personal medical device, consult the manufacturer of your device to determine if it is adequately shielded from external RF energy. Your physician may be able to assist you in obtaining this information.

Turn your phone OFF in health care facilities when any regulations posted in these areas instruct you to do so. Hospitals or health care facilities may be using equipment that could be sensitive to external RF energy.

Vehicles: RF signals may affect improperly installed or inadequately shielded electronic systems in motor vehicles. Check with the manufacturer or its representative regarding your vehicle. You should also consult the manufacturer of any equipment that has been added to your vehicle.

Posted Facilities: Turn your phone OFF in any facility where posted notices so require.

Aircraft

FCC regulations prohibit using your phone while in the air; switch off your phone before boarding an aircraft unless otherwise advised by airline personnel.

Blasting areas

To avoid interfering with blasting operations, turn your phone OFF when in a “blasting area” or in other areas posted: “Turn off two-way radio.” Obey all signs and instructions.

Potentially explosive atmospheres

Turn your phone OFF when in any area with a potentially explosive atmosphere and obey all signs and instructions. Sparks in such areas could cause an explosion or fire resulting in bodily injury or even death.

Areas with a potentially explosive atmosphere are often, but not always, clearly marked. They include fueling areas such as gas stations; below deck on boats; fuel or chemical transfer or storage facilities; vehicles using liquefied petroleum gas (such as propane or butane); areas where the air contains chemicals or particles, such as grain, dust or metal powders; and any other area where you would normally be advised to turn off your vehicle engine.

For vehicles equipped with an air bag

An air bag inflates with great force. DO NOT place objects, including both installed or portable wireless equipment, in the area over the air bag or in the air bag deployment area. If in-vehicle wireless equipment is improperly installed and the air bag inflates, serious injury could result.

For U.S. Customers: Vehicles using liquefied petroleum gas (such as propane or butane) must comply with the National Fire Protection Standard (NFPA-58).

For a copy of this standard, contact:

National Fire Protection Association

One Batterymarch Park

PO Box 9101

Quincy, MA 02269

Phone: 1-800-344-3555

Web site: www.nfpa.org E-mail address: Custserv@NFPA.org

See “Consumer Update” starting on page 139 for the FDA Consumer Update on Mobile Phones published by the U.S. Food and Drug Administration.

Ten (10) driver safety tips

Your wireless telephone gives you the powerful ability to communicate by voice-almost anywhere, anytime. But an important responsibility accompanies the benefits of wireless phones, one that every user must uphold.

When driving a car, driving is your first responsibility. When using your wireless phone behind the wheel of a car, practice good common sense and remember the following tips:

1. **Get to know your wireless phone and its features such as speed dial and redial.** If available, these features help you to place your call without taking your attention off the road.
2. **When available, use a hands free device. If possible,** add an additional layer of convenience and safety to your wireless phone with one of the many hands free accessories available today.
3. **Position your wireless phone within easy reach.** Be able to access your wireless phone without removing your eyes from the road. If you get an incoming call at an inconvenient time, if possible, let your voice mail answer it for you.
4. **Let the person you are speaking with know you are driving; if necessary, suspend the call in heavy traffic or hazardous weather conditions.** Rain, sleet, snow, ice, and even heavy traffic can be hazardous.
5. **Do not take notes or look up phone numbers while driving.** Jotting down a "to do" list or flipping through your address book takes attention away from your primary responsibility, driving safely.
6. **Dial sensibly and assess the traffic; if possible, place calls when you are not moving or before pulling into traffic.** Try to plan calls when your car will be stationary. If you need to make a call while moving, dial only a few numbers, check the road and your mirrors, then continue.
7. **Do not engage in stressful or emotional conversations that may be distracting.** Make people you are talking with aware you are driving and suspend conversations that have the potential to divert your attention from the road.
8. **Use your wireless phone to call for help.** Dial 9-1-1 or other local emergency number in the case of fire, traffic accident or medical emergencies. Remember, it is a free call on your wireless phone!
9. **Use your wireless phone to help others in emergencies.** If you see an auto accident, crime in progress or other serious emergency where lives are in danger, call 9-1-1 or other local emergency number, as you would want others to do for you.
10. **Call roadside assistance or a special non-emergency wireless assistance number when necessary.** If you see a broken-down vehicle posing no serious hazard, a broken traffic signal, a minor traffic accident where no one appears injured, or a vehicle you know to be stolen, call roadside assistance or other special non-emergency wireless number.

"The wireless industry reminds you to use your phone safely when driving."

For more information, please call 1-888-901-SAFE or

visit www.wow-com.com

Information on this page provided by the Cellular Telecommunications Industry Association.



Care and maintenance



Pressing any of the keys may produce a loud tone. Avoid holding the phone close to your ear while pressing the keys.



Extreme temperatures may have a temporary effect on the operation of your phone. This is normal and does not indicate a fault.

If you use your phone in a temperature over +104°F(+40°C) for a long time, the display quality may deteriorate.



Do not modify or disassemble the equipment. There are no user serviceable parts.



Do not subject the equipment to excessive vibration or shock.
Do not drop the battery.



Avoid contact with liquids. If the equipment becomes wet immediately remove the battery and contact your dealer.



Do not leave the equipment in direct sunlight or a humid, dusty or hot area. Never throw a battery into a fire. It may explode.



Keep metallic items that may accidentally touch the terminals away from the equipment/battery.

Batteries can cause property damage, injury, or burns if terminals are touched with a conductive material (i.e. metal jewellery, key, etc.).



Always charge the battery in a well ventilated area, not in direct sunlight, between +41°F(+5°C) and +95°F(+35°C). It is not possible to recharge the battery if it is outside this temperature range.



When connecting the phone to an external source, read the operating instructions of the equipment for the correct connection and safety precautions. Ensure the phone is compatible with the product it is being connected to.



When disposing of any packing materials or old equipment check with your local authorities for information on recycling.

Overview of features

Your phone has the following features:

Bluetooth® connectivity

Use this to make and receive calls using wireless Bluetooth® Headsets or Car Kits. Also to transfer data to and from PCs, Laptops, other mobile phones and devices that support Bluetooth®.

Calculator

Use this to perform basic calculations.

Camera

Use the digital camera to take pictures to send in your messages or use as your wallpaper.

Converter

Use this to convert currency values when you are abroad.

Games

Use this to play games on your phone.

Infrared connectivity

Use this to transfer information between your phone and another device that has an infrared port.

MMS (Multimedia Messaging)

Use this to send and receive pictures, sounds and text.

Schedule

Use this to set reminders for important events.

SMS (text messaging)

Use this to send and receive text messages.

SMS Chat

Use this to have a text conversation.

Synchronization

Use this to synchronize your Schedule and Contacts List with an external server.

Voice dial

Use this to dial a number by talking to the phone.

WAP browser

Use this to access the Internet.

SIM and battery

Fitting and removing the SIM

You insert the SIM into the back of the phone, underneath the battery.

If your SIM contains contact details, the first time that you turn the phone on after you have fitted the SIM, you are asked whether you want to transfer the SIM data to your phone.

Fitting the SIM



Removing the SIM



Note: If you are upgrading your phone, and your previous phone did not support new services, such as Multi Media Messaging, you may need to insert a new SIM. Contact your Service Provider.

Fitting and removing the battery

Before you remove the battery, ensure that the phone is switched off and that the charger is disconnected from the phone.

Fitting the battery



Removing the battery



Note: When attaching or removing the battery, ensure the charger is disconnected, the phone is powered off and is folded closed.

Caution: Using non-Panasonic accessories or accessories not recommended by your wireless service provider may result in poor performance of your phone, or even cause an electrical hazard.

Charging the battery

The battery must be fitted in the phone before you connect the charger. Press the button on the top of the connector and insert it into the base of the phone.

Note: Do not force the connector as this may damage the phone and/or the charger.





Connect the charger into a standard AC wall outlet. When the phone is charging, the charging indicator lights and a flashing plug icon appears in the main display and the case screen.



When charging is complete, unplug the charger from the wall outlet and disconnect the charger.



While the battery is charging, the following icons appear on the phone's display and case screen:

	While charging	Charging complete
Phone on	 Flashing	
Phone off	 Flashing	No icon.
Charging problem	Charge fault icon (). See Troubleshooting on page 133 for details of what to do.	

Low battery warning

When the battery power is low, a warning tone sounds, and a flashing low battery icon () is displayed. If this happens during a conversation, end your call immediately. The power automatically shuts off after the warning tone.

You need to fully recharge your battery, see Charging the battery on page 16. You can still make and receive calls while the battery is charging.

Note: Some settings may be lost if the battery is removed or remains discharged for more than 1.5 hours.

Quick start

Note: Some services are network dependent or may only be available on a subscription basis. Some functions are SIM dependent. For more information contact your Service Provider.

Switching the phone on and off

To switch the phone on or off, press and hold .

If you have set an animation and greeting, these are displayed. The phone starts in idle mode.



Making calls

Ensure that the phone is switched on, the network operator logo is displayed and the signal strength icon shows that network coverage is available in the current area.

- ▶ From idle mode, enter the area code and phone number.
- ▶ Press .

Locking the keypad

You can lock the keypad to avoid accidentally making calls when the phone is in your bag or pocket.

- ▶ From idle mode press and hold .
- ▶ Select **Keyguard**.
- ▶ Press  twice.

To unlock the keypad:

- ▶ Press  twice.

Camera mode

To change to camera mode either select **Camera** from the main menu (press  twice), or press  from idle mode if the shortcut key is set for camera.

Leaving camera mode

To leave camera mode press  to return to idle mode.

Taking a picture

- ▶ When you are in camera mode, move the phone around until you can see the image you want on the preview screen.
- ▶ Press  to capture the image.

If you decide that you do not want the image that you have taken, you can press  to delete it.

Setting the wallpaper

The wallpaper is a picture that displays when the phone is in idle mode.

- ▶ Select **Menu** > **Data Folders**.
- ▶ Find a picture.
- ▶ Select **Menu** > **Use As** > **Wallpaper**.

Or

- ▶ Select **Menu** > **Settings** > **Display** > **Wallpaper**.
- ▶ Select the folder where the picture is stored.
- ▶ Select your picture.

Setting the ring type

- ▶ Select **Menu** > **Data Folders**.
- ▶ Find a sound.
- ▶ Select **Menu** > **Use As**.
- ▶ Select the type of call.

Or

- ▶ Select **Menu** > **Settings** > **Alerts** > **Ring Type**.
- ▶ Select the type of call that you want to change.
- ▶ Select the folder where your sound is stored.
- ▶ Select your sound.

Setting quiet mode

In quiet mode the microphone amplifies your voice, so you can whisper and still be heard by the person on the other end of the call. You should use quiet mode in situations where you do not want to disturb the people around you.

In quiet mode, the phone will not ring when you receive a call or message, unless you set a ring volume for quiet mode.

From idle mode, press and hold .

Or

Select **Menu** > **Settings** > **Alerts** > **Quiet Mode** > **On/Off** > **On**.

Using your browser

Before you can start using your browser, you need to contact your Service Provider.

When your phone is set up to access the internet see Home page on page 69 for information about the using the browser.

Creating a multimedia message



Use the **Create** option on the **Messaging** menu to create a multimedia (MMS) message.

- ▶ Select **Create > MMS**.
- ▶ Press **⓪**.
- ▶ Select the item that you want to enter.
- ▶ When your message is complete, select **Ok**.
- ▶ Select **Addr.:**
- ▶ Select **Edit** to enter an address.
- ▶ Enter an address.
- ▶ Select **Subj.:**
- ▶ Select **Edit** to enter a subject.
- ▶ Enter a subject.

To send your message, press **ⓧ** or press **⓪** and select **Send**.

To save your message press **⓪** and select **Save**. Your message is stored in the **Outbox**, so you can send it or edit it later.

Creating a text message



Use the **Create** option on the **Messaging** menu to create a text (SMS) message.

- ▶ Select **Create > SMS**.
- ▶ Enter your text.
- ▶ Press **⓪**.
- ▶ Select **Ok** or **Cancel**.
- ▶ Press **⓪** to send the message.
- ▶ Enter the phone number.
- ▶ Press **⓪**.
- ▶ Select **Ok** or **Cancel**.
- ▶ If you selected **Ask** as your Receipt option, then you are asked '**Request Delivery Confirmation?**' Press **⓪**, then select **No** or **Yes**.

Setting up the Bluetooth® headset

The Bluetooth® headset is available as an optional accessory (EB-BHX70). It gives you wireless, handsfree operation up to approximately 33 feet.

Before you can use the headset you need to Pair the headset and the phone.

First you need to turn on Bluetooth® on the phone:

Select **Menu > Connect > Bluetooth > On/Off > On**, or select **Menu > Organiser > Connect > Bluetooth > On/Off > On**.

Note: Depending on your SIM, **connect** appears in Organizer.

The Bluetooth® icon appears on the screen.

You now need to set up the headset:

- ▶ Turn on the headset. (See headset instructions).
- ▶ Make the headset Discoverable. (See headset instructions).

Note: To turn the EB-BHX70 headset on and make it Discoverable, hold down the main function key for 10 seconds.

The headset is only Discoverable for a few minutes. If it is not Discovered during this period, the Pairing will fail. You can try again by making the headset Discoverable again.

Finally you need to pair the devices:

- ▶ On the phone select **Discover & Pair**.
As the phone discovers devices it displays them on the screen.
- ▶ When the headset appears in the list you can select **Stop** to stop the search.
- ▶ If the phone does not discover your headset, press  to try again.
- ▶ Highlight the headset in the list.
- ▶ Select **Pair**.
- ▶ Enter the Bluetooth® Passkey provided with the headset.

Note: The Passkey for Panasonic EB-BHX70 Bluetooth® Headset is 0000.

The Pairing will fail if you enter the wrong Passkey. Press **Retry** to try again.

You can select **Paired Devices** to confirm that the devices are paired. This lists all the devices that are paired with the phone.

Once the headset and phone are Paired, you can use the headset to make and answer calls.

To make calls from your EB-BHX70 headset, the headset must be on. Press the main function button on your headset, then, after the tone, use voice dialing. To answer a call with your EB-BHX70 headset, the headset must be on. When the headset rings, press the main function button to answer the call. To end a call press the main function button again.

Setting up Bluetooth® car kits

Your X70 works with a wide range of Bluetooth® car kits. With a Bluetooth® car kit you can operate your X70 handsfree without plugging it into a car holder.

Before you can use your car kit you need to Pair it with the phone.

First you need to turn on Bluetooth® on the phone:

Select **Menu > Connect > Bluetooth > On/Off > On**, or select **Menu > Organiser > Connect > Bluetooth > On/Off > On**.

The Bluetooth® icon appears on the screen.

You now need to make the car kit Discoverable:

- ▶ Turn on the car kit.
- ▶ Make the car kit Discoverable. (See car kit instructions. Some car kits are permanently Discoverable.)

Finally you need to Pair the devices:

- ▶ On the phone select **Discover & Pair**.
As the phone Discovers devices it displays them on the screen.
- ▶ When the car kit name appears in the list you can select **Stop** to stop the search.
- ▶ If the phone does not Discover your car kit, press  to try again.
- ▶ Highlight the car kit in the list.
- ▶ Select **Pair**.
- ▶ Enter the Bluetooth® Passkey provided with the car kit.

You can select **Paired Devices** to confirm that the devices are Paired. This lists all the devices that are Paired with the phone.

Once the car kit and phone are Paired, you can make calls and answer calls using the car kit. To make calls from your car kit, press the green call button on your car kit, then, after the tone, use voice dialing. To answer a call with your car kit, press the green call button. To end a call press the red end call button on your car kit.

Note: Voice dial recordings must be loud to ensure confirmation is audible when using some car kits.

Your phone

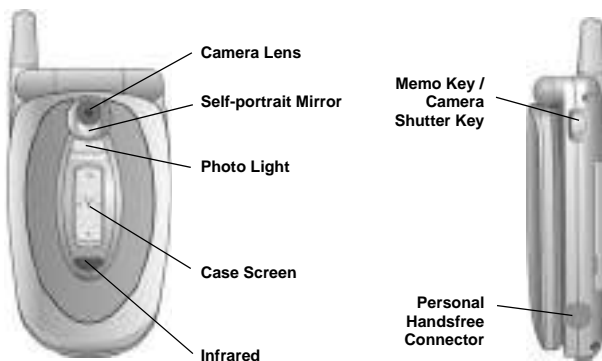
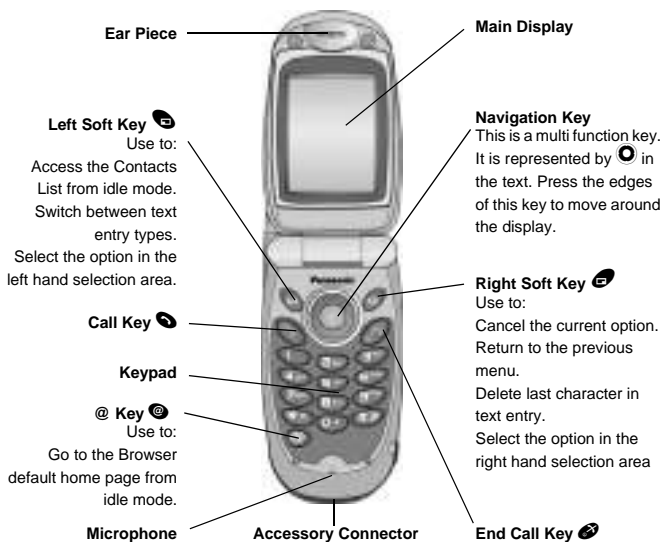









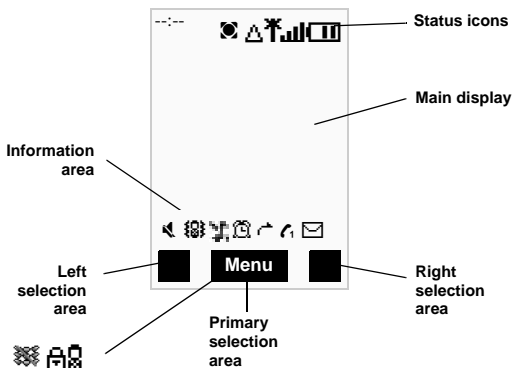

















Display icons

After some operations, the display automatically clears after three seconds or when you press any key.

Status icons

The status icons are displayed according to the currently activated functions. The antenna, GSM signal strength and battery icons are displayed when the phone is switched on and connected to a network.



	Registered to a non-home network - Roaming.
	The selected line number of the current call when using a SIM that has two lines. This is SIM dependent. 
	The call you are currently listening to when you are connected to more than one call. Any other calls listed on the display are on hold. This is SIM dependent. 
	Call divert on.
	New message received. A flashing envelope indicates that your message store is full.
	GPRS service available.
	Antenna. Indicates that you can make a call. If it is the only icon displayed, you can only make emergency calls.
	GSM signal strength:  - weak signal,  - strong signal.
	Battery level:  - full,  (flashing) - low.
	Abnormal battery charging
	All tones off or ring volume off.
	Vibration alert on.
	Quiet mode on. (Case Screen:   P 
	Phone lock on.
	Alarm set.
	Bluetooth® on. Flashes when Discoverable.

Note: All screen images in the manual are simulated.

Menu structure

The nine main menus are as follows:

Note: The menus may not display in the same order or with the same icons as listed here. The order and icons vary according to your Service Provider.



Settings

- 1 Display
- 2 Alerts
- 3 Keys
- 4 Phone Settings
- 5 Clock
- 6 Call Service
- 7 Call Divert
- 8 Security
- 9 Network
- 10 Defaults



Contacts List

- 1 Browse
- 2 Create
- 3 Voice Dial
- 4 Groups
- 5 Settings
- 6 SIM
- 7 Storage



Games

- 1 Space War
- 2 Roller Kid
- 3 Panko
- 4 Crazy Cobra
- 5 Demo
- 6 Welcome
- 7 Instructions
- 8 Settings



Browser

- 1 Home Page
- 2 Bookmarks
- 3 Enter URL
- 4 Page Memo
- 5 Push Message
- 6 Browser Settings
- 7 Server List
- 8 Cookie
- 9 Last Status



Camera



Messaging

- 1 Settings
- 2 Inbox
- 3 Broadcasts
- 4 Voice Mail
- 5 Create
- 6 e-mail
- 7 Data Folders
- 8 Outbox
- 9 SMS Chat



Data Folders

- 1 My Pictures
- 2 My Sounds
- 3 My Themes
- 4 User 1 - 5



Organiser

- 1 Synchronization
- 2 Contacts List
- 3 Converter
- 4 Business Card
- 5 Schedule
- 6 Calculator
- 7 Alarm
- 8 Memo
- 9 Receive Object







Connect

- 1 Bluetooth
- 2 Infrared Dialup
- 3 Receive Object

Note: Depending on your SIM, **Connect** appears in **Organiser** instead of **Receive Object**.

Navigation key

The navigation key is a multi-function key. You use the top, bottom, left and right edges to move around the display. These actions are indicated by , ,  and  in this user guide. You press the center of the navigation key  to:

- Access the menu system.
- Display a submenu.
- Select a highlighted menu item.
- Confirm a selection.
- Select the item in the primary selection area.
- Take a picture with the camera

Menu shortcuts

When you are familiar with the menu system, you can enter the menu number instead of navigating through the display menus. For example, to browse your contacts list:

From idle mode, press , 2, 1.

Voice calls

Making calls

Ensure that the phone is switched on, the network operator logo is displayed, and the antenna and signal strength icons (📶) show that network coverage is available in the current area.

- ▶ From idle mode, enter the area code and phone number.
- ▶ Press 📞.

Ending calls

Press 📞.

Answering a call

To receive a call the phone must be switched on and the signal strength icon (📶) must be displayed.

To answer a call, press any key except 📞, 📶, 📶.

Note: You can set **Answer key**, if you want to answer calls by pressing only 📞.
Settings > Keys > Answer key > Send key

Answering a call handsfree

Press and hold 📞.

Note: Do not hold the phone to your ear when in handsfree mode.

Sending DTMF tones during a call

You can send DTMF tones during a call to access voice mail, paging and computerized home banking. For example, you may need to enter a number to remotely access voice mail messages.

To send DTMF tones during a call, press the required digit keys.

Pause Dial

Using pauses allows you to send DTMF tones automatically.

- ▶ Enter phone number.
- ▶ Press and hold 📞 until **P** is displayed.
- ▶ Enter DTMF numbers.
- ▶ Press 📞.

Rejecting a call

If you do not want to answer an incoming call, press .

Note: If you reject a call, “**Unanswered xx Calls**” will be displayed.



(xx: the number of calls you have not answered)

Press  for **Unanswered Call** display to appear.

Making international calls

If you know the international number, you can enter it in the normal way, followed by the area code and phone number.

You can use the automatic international access code (+), to dial international numbers without knowing the code for the international exchange.

- ▶ From idle mode, press and hold  until + is displayed.
- ▶ Use  to scroll through a list of country codes.
- ▶ Select the code you want.
- ▶ Enter the area code and phone number.
- ▶ Press .



Note: Many countries/regions include an initial 0 in the area code. In most cases, you should omit this when dialing international numbers. If you have difficulties making international calls, contact your Service Provider.



Making emergency calls

To make an emergency call, the antenna symbol () must be present.

If a SIM is installed, enter 911 and press .

If a SIM is not installed, press , select **SOS**, press .

Note: Making Emergency calls without a SIM installed is country or network operator dependent.

Voice calls using Bluetooth® headset or car kit

Making calls

You can use voice dial (see Creating a voice dial entry on page 60 for instructions on how to use voice dial.) to make voice calls from your Bluetooth® headset or car kit without pressing any keys on the X70. With some headsets and car kits you can also redial the last number (refer to your headset or car kit instruction for details).

To make a voice dial call using your Bluetooth® headset or car kit:

- ▶ Press the main function button on the EB-BHX70 headset, or the green call button on most car kits.
- ▶ Wait for the tone. X70 displays **Please Call Voice Command**.
- ▶ Speak the voice command.
- ▶ X70 repeats the voice dial entry back for confirmation. If you hear a double tone, then the voice command has failed.
- ▶ X70 dials the number.

To end the call, press the main function button on the EB-BHX70 headset, or the red end button on most car kits.

Note: Bluetooth® must be switched on (Connect > Bluetooth > On/Off > On) and your Bluetooth® headset or car kit must be Paired with your X70, see *Discovering and pairing devices* on page 122 for details.

Your voice dial recordings need to be loud to ensure that they are audible when you use a car kit.

Receiving calls

You can answer voice calls using your Bluetooth® headset or car kit without pressing any keys on the X70.

When the Bluetooth® headset or car kit rings, press the main function button on the EB-BHX70 headset or the green call button on most car kits. This answers the call with audio on the headset or car kit.

To end the call, press the main function button on the EB-BHX70 headset, or the red end button on most car kits.

Note: Only the default Bluetooth® audio device will ring. If this device is switched off or out of range, you can answer the call from any other Paired headset or car kit. See *Selecting default audio device* on page 123 for details of how to select the default audio device.

Rejecting calls

To reject an incoming call:

- ▶ Wait until the headset or car kit rings.
- ▶ Press and hold down the main function key on the EB-BHX70 headset until you hear a low tone, or press the red end button on most car kits.

Transferring calls from handset to Bluetooth® headset or car kit

If you make a call using your handset, you can transfer the call to your headset or car kit once the call is connected.

Voice calls

- ▶ Press the main function button on the EB-BHX70 headset, or the green call button on most car kits.
- ▶ The display reads **Voice Call Bluetooth**.

Alternatively, you can select **Menu > Bluetooth**. The display reads **Transferring Audio to Bluetooth**, then changes to **Bluetooth Audio Transfer Complete**.

Note: If you transfer the call using the **Menu**, then the call is transferred to the default audio device. See *Selecting default audio device* on page 123 for information about selecting your default audio device.

Transferring a call from Bluetooth® headset or car kit to handset

If you are making a call using your headset or car kit, you can transfer the call to your handset.

- ▶ On the handset, select **Menu**.
- ▶ Select **H'held**.

Using automatic redial



If a connection is unsuccessful, press  when **Ok** is displayed.

To stop redialing, press  when **Cancel** or **C** is displayed.

Using hotkey dialing

If you have set up hotkey dialing, you can press and hold a digit key to display an assigned contact. Press  to dial the number.

As each entry is stored in your **Contacts List** a numbered location is assigned, pressing and holding the digit key relating to that number will display the **Contact**.

For digits “10” and above press  after selecting the numbered location then  to dial the number.

Note: The following Keys may be preset by your service provider and can not be changed.

: “Voice mail” number

: Games

Displaying caller ID

Note: This is network dependent .

If the caller’s number and name are stored in your **Contacts List**, they can be displayed during an incoming call.

Note: Caller ID may not always be available.

Setting the ear piece volume

During a call press  to adjust the ear piece volume.

Note: You can adjust the volume for the personal handsfree, Bluetooth® headset or Bluetooth® car kit accessories in the same way.

Swapping between handsfree and handheld modes

During a call:

From handheld to handsfree

- ▶ Press .
- ▶ Select **H'free**.

From handsfree to handheld

- ▶ Press .
- ▶ Select **H'held**.

Holding a call

- ▶ Press .
- ▶ Select **Hold**.

Resuming a call

- ▶ Press .
- ▶ Select **Resume**.





Making a second call

Note: This is network dependent .

If **Call Waiting** is enabled, you can make a second call. You can check your call waiting status from **Settings > Call Service > Calls > Call Waiting**.

Note: You cannot make more than one fax or data call at a time.

You must end all voice calls before you can make or receive a fax or data call.

- ▶ Press .
- ▶ Select contact number to dial. Press  .
- ▶ Select **Recall**.
- ▶ Press .

- ▶ Press .

The first call is put on hold.

Receiving a second call

Note: This is network dependent .

If **Call Waiting** is enabled, you can receive a second call. You can check your call waiting status from **Settings > Call Service > Calls > Call Waiting**.



Note: You cannot receive more than one fax or data call at a time.
You must end all voice calls before you can make or receive a fax or data call.

Accept or reject a second call

- ▶ Press .
- ▶ Select **Accept** or **Reject**.

Note: If you accept the second call, the current call is put on hold.

End current call and receive second call

- ▶ Press .
- ▶ Press  to answer the second call.

Operating during two calls

Swapping between calls

An icon  indicates the current call, when connected to two calls.

- ▶ Press .
- ▶ Select **Swap** to change to the other call.

Ending current call

- ▶ Press .
- ▶ Select **End**.

Ending both calls

Press .

Transferring a call

When you are connected to two calls, you can connect them together, and end your connections, leaving the two callers to talk to each other.

- ▶ Press .

- ▶ Select **Trans**.

Note: You cannot do this while in multi-party mode.

Multi-party calls

Note: This is SIM dependent .

In a multi-party call three to five people can have a conversation at the same time. You can swap between a multi-party call and another call as you do for two separate calls.

Enabling a multi-party call

- ▶ With two calls connected (one active and one on hold), press .
- ▶ Select **Merge**.

All three parties can now talk to each other.

Adding people



You can add people to the multi-party call (up to a maximum of five), either by making a call or accepting an incoming call. You can then merge the new call into the multi-party.

- ▶ Press .
- ▶ Select **Merge**.

Note: When you make a call or accept an incoming call, the multi-party call is placed on hold. The other callers in the multi-party call can continue to talk to each other while on hold from you.

Splitting a multi-party call

You can select a caller from the multi-party call and remove their connection, so that you can talk privately to them.

- ▶ Press .
- ▶ Select **Option**.
- ▶ Select a caller.
- ▶ Press .
- ▶ Select **Split**.

The selected caller is split from the multi-party and the multi-party call is placed on hold. The remaining multi-party callers can still talk to each other.

Rejoining a multi-party call



When you have finished talking to an individual you can rejoin the multi-party call:

- ▶ Press .

Voice calls

- ▶ Select **Merge**.

Ending a single connection to a multi-party call

- ▶ Press .
- ▶ Select **Option**.
- ▶ Select a caller.
- ▶ Press .
- ▶ Select **End**.

Note: You cannot end an individual caller if you have a call on hold or another call is incoming.



Ending all connections to a multi-party call

Press .

Note: This ends all calls, including those on hold or split from the multi-party call.

Using the notepad

During a call you can enter numbers that you may want to dial when you have finished the call. You can make a note of these numbers on the notepad.

- ▶ Enter the number.
- ▶ When you have finished your call, press  to dial the number.
or
- ▶ Press  while the number is displayed to store the number in your **Contacts List**.
The current call remains active.

In call options



During a call select **Menu > Menu** to access the following menus:























Schedule, Browser, Contacts List, Messaging and Memo.

For information on using these menus, see the relevant section in this user guide.

Text entry

You use alphanumeric characters to enter details into the **Contacts List**, to create text and e-mail messages.

There are five different text entry modes: Multi tap (ABC,abc,Abc), numbers (0-9) and T9® (T9,T9↑,T9↓). To change your text entry mode press , or select **Menu > Input Mode**, and select the mode that you want. The icon for the current mode appears in the information area on the display. To change between upper and lower case letters press . The table below shows the characters that you can enter in the different text modes.

Text Mode			
Key	T9® (T9,T9↑,T9↓)	Multi tap (ABC,abc,Abc)	Numeric (0-9)
	Alternatives	+ _ 	0 
	① ②	① 	1
	ABC (abc)	ABC (abc) 	2
	DEF (def)	DEF (def) 	3
	GHI (ghi)	GHI (ghi) 	4
	JKL (jkl)	JKL (jkl) 	5
	MNO (mno)	MNO (mno) 	6
	PQRS (pqrs)	PQRS (pqrs) 	7
	TUV (tuv)	TUV (tuv) 	8
	WXYZ (wxyz)	WXYZ (wxyz) 	9
	Shift/Lock	Shift/Lock	*
	Space + ⑤	Space	#

Attention

- ① @ / : ; * # + - “ , ! ; ? ` _ () [] { } ’ & % \ ^ ~ | < > = € £ \$ ¥ ¢ §

You can use following punctuation by pressing and holding the key.

- ② ... ① and 0~9
- ③ ... ① and 0~9 , A~Z , a~z (Multi tap)
- ④ ... 0 + P _
- ⑤ ... If you press and hold  while you are creating text, a list of the user defined message is displayed.



Note: Displayed characters of T9® depend on the selected language.

Text entry

T9®

Using T9® reduces the number of key presses required.

When in T9® mode:

- ▶ Press  key once for any letter you require on that key. The desired letter may not be displayed.
- ▶ Continue pressing other keys until the end of a word is reached.
- ▶ Check that the word has been typed correctly before continuing to the next word.
- ▶ If the combination of letters typed has produced a word which is not the one you require, press  or  until the correct word is displayed.
- ▶ Continue to the next word.
- ▶ If the word you require is not in the internal dictionary, you can enter it using the Multi tap mode, or add it to the internal T9® dictionary.



Adding entries to the T9® dictionary

If the internal T9® dictionary does not contain a word, name, or abbreviation that you require, you can add it. Words that you add to the T9® dictionary are available for future use.

- ▶ From Multi tap mode, enter the required word.
- ▶ When the word is complete, press  to select T9® entry mode.

T9® is a trademark of Tegic Communications Inc. T9® Text Input is licensed under one or more of the following: U.S. Pat Nos. 5,818,437, 5,953,541, 5,187,480, 5,945,928, and 6,011,554; Canadian Pat No. 1,331,057; United Kingdom Pat No. 2238414B; Hong Kong Standard Pat. No. HK0940329; Republic of Singapore Pat No. 51383; Euro. Pat No. 0 842 463 (969272260.8) DE/DK,FI, FR, IT, NL, PT, ES, SE, GB: and additional patents are pending worldwide.

Entering text

In Multi tap mode, each time you press a key in quick succession the next character available on that key is displayed. For example, to enter 'on' you need to press  three times in quick succession. To enter the displayed character, release the key or press another key. The cursor then moves to the next position. If you want to enter two consecutive letters from the same key, for example 'on' or 'll', you may need to press  to move to the next position.

You can also select characters from the character list. You can display the character list by pressing and holding a text entry key, or by selecting **Menu > Char.List**. Only the characters available in your current text entry mode are displayed.

Editing text

Press  to move up or down one line of text.

Press  to move left or right one character.

Press  to delete the character to the left of the cursor.

Press and hold  to delete the current line.

If you move the cursor over a character and press another key, the new character is inserted immediately before the selected character.

Cut, copy and paste

You can cut, copy and paste text from other messages or contacts list entries on your phone.

To cut text:

- ▶ Select **Menu > Cut**.
- ▶ Move to the start of the text that you want to cut, and select **Start**.
- ▶ Use  to highlight the text that you want to cut, and select **Stop**.

To copy text:

- ▶ Select **Menu > Copy**.
- ▶ Move to the start of the text that you want to copy, and select **Start**.
- ▶ Use  to highlight the text that you want to copy, and select **Stop**.

You can only paste text if you have previously cut or copied some text. To paste text:

- ▶ Move where you want to paste the text.
- ▶ Select **Menu > Paste**.



Settings

Use the **Settings** menu to personalise your phone.

Display

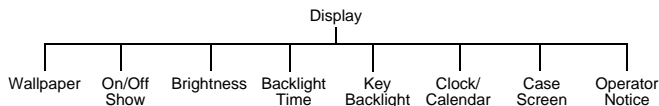

Setting the wallpaper

The wallpaper is a picture that displays when the phone is in idle mode.

- ▶ Select **Wallpaper**.
- ▶ Select your picture.

If the required picture is not there, press , then select another folder.

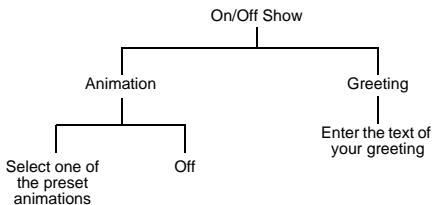

Changing the start up events

The start up events are an animation that you can select and a greeting that you enter. These appear when you turn on the phone. The animation is also shown when you turn off the phone.



Setting the brightness

You can adjust the brightness of the display. To make the display brighter select +1, to dim the display select -1.

- ▶ Select **Brightness**.
- ▶ Use  to move between +1, 0 and -1.
- ▶ Press .

Setting the backlight time

The **Backlight Time** is the time that your screen remains lit when you are not using your phone.

- ▶ Select **Backlight Time**.
- ▶ Select from **10 seconds**, **30 seconds** and **60 seconds**.

Note: Setting the **Backlight Time** to 60 seconds, can reduce the talk and standby time of your battery.

Setting the key backlight

The **Key Backlight** illuminates your phone's keys.

- ▶ Select **Key Backlight**.
- ▶ Select **On** or **Off**.

Note: Turning on the **Key Backlight** can reduce the talk and standby time of your battery, and is dependant upon the Backlight Time setting.

Displaying the clock/calendar in idle mode

You can choose whether or not to display a clock or calendar on the screen when in idle mode. Use  to move between the options.

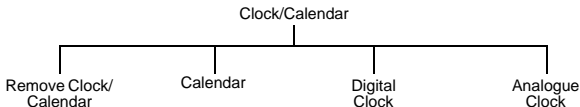

Changing the case screen settings

The **Case Screen** is the screen on the front of the phone. It has a clock, icon area, incoming message area and call alerts area.

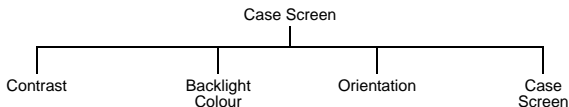

Settings

Changing the contrast

- ▶ Select **Contrast**.
- ▶ Use  to move between 0 and 10.
- ▶ Select **Ok**.

Changing the backlight colour

You set the backlight colour, to see what type of call you are receiving, or what mode you are in when the phone is closed. You can set the backlight colour for:

- Alarm/Schedule
- Voice Calls
- Fax Calls
- Data Calls
- Messages
- MMS Notify
- WAP Services
- Voicemail
- Camera Mode
- Others

To set your backlight colours:

- ▶ Select **BacklightColour**.
- ▶ Select the item you want to change.
- ▶ Select a colour.

Changing the orientation

The orientation changes the alignment of the information on the case screen.

- ▶ Select **Orientation**.
- ▶ Select **Left** or **Right**.

Changing the case screen display

- ▶ Select **Case Screen**.
- ▶ Select from **Clock/Status**, **Analogue** and **Digital**.

If you select **Clock/Status**, the battery level and GSM signal strength appear in the information area.

Operator notice

Note: This option is SIM dependent.

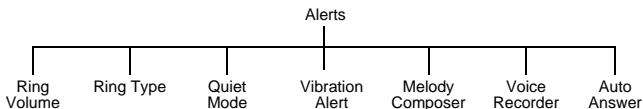

If you disable **Operator Notice**, you will not receive messages from your Service Provider.

Alerts



Changing the ring volume

You can change the ring volume so that you can hear your phone ring. For example, in a noisy environment you may want to set the volume to maximum.

- ▶ Select **Ring Volume**.
- ▶ Use  to move between 0 and 4 on the volume scale and Steptone.
- ▶ Press  to select the new volume level.

Note: This option is unavailable if you are in quiet mode.

Setting the ring type

Use ring type to select the sound you want to hear when you receive a call.

- ▶ Select **Ring Type**.
- ▶ Select the type of call that you want to change.
- ▶ Select your sound.

If your sound is not in the folder press  then select another folder.

Setting quiet mode

In quiet mode the microphone amplifies your voice, so you can whisper and still be heard by the person on the other end of the call. You should use quiet mode in situations where you do not want to disturb the people around you.

In quiet mode, the phone will not ring when you receive a call or message, unless you set a ring volume for quiet mode.

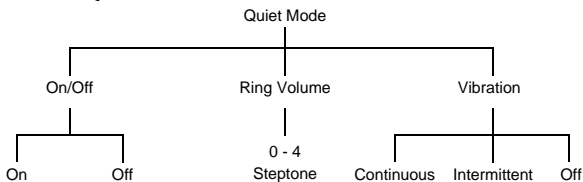

Setting a vibration alert

If you set a vibration alert, the phone vibrates when you receive a call or message. This setting is separate from the vibration alert that you set for quiet mode.

- ▶ Select **Vibration Alert**.
- ▶ Select from **Continuous**, **Intermittent** and **Off**.

Creating a ring type

- ▶ Select **Melody Composer** > **Create**.
- ▶ Using the following table, enter the notes, rests and duration to create your melody.

Key	1 st press	2 nd press	3 rd press	4 th press	5 th press
1	C2	C3	C4	C1	
2	D2	D3	D4	D1	
3	E2	E3	E4	E1	
4	F2	F3	F4	F1	
5	G2	G3	G4	G1	
6	A2	A3	A4	A1	
7	B2	B3	B4	B1	
0	Rest				
*	1/8	1/4	1/2	1	1/16
#	Sharp				

When you have completed your melody, you can save it:

- ▶ Press .
- ▶ Select **Ok**.
- ▶ Enter a name.
- ▶ Select **Save**.
- ▶ Select the folder where you want to save your melody.

At any time during your composing, you can press  to play back your melody.

Once you have saved your melody you can edit it.

- ▶ Select **Edit** from the **Melody Composer** menu.
- ▶ Select the data folder where your melodies are stored.
- ▶ Select the melody you want to edit.
- ▶ Select **Edit**.
- ▶ Use the relevant keys to insert new notes and rests.

Note: The only restriction on the number of melodies you can compose is the space remaining in your data folders.

Recording a voice message

You can record a message to use as your ring type.

- ▶ Select **Voice Recorder > Record**.
- ▶ Record your message.
- ▶ Enter a name.
- ▶ Select **Save**.
- ▶ Select the folder where you want to save your voice message.

You can now select and use this sound in the same way as you do for any other ring types.

Once you have recorded a voice message you can edit it. Select **Edit** from the **Voice Recorder** menu, then edit it as necessary.

Setting auto answer

When auto answer is on, and your phone is connected to a car kit or personal handsfree adaptor, incoming calls are automatically answered.

Select **Auto Answer > On**.

To turn off auto answer:

Select **Auto Answer > Off**.

Keys

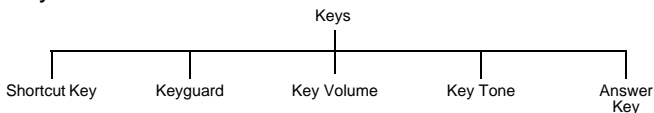

Choosing the function for the shortcut key

The right soft key () is a shortcut key from idle mode. You can choose which function you want this key to access. The default is camera.

- ▶ Select **Shortcut Key**.
- ▶ Select the function that you want.



Setting the keyguard

The keyguard stops the keypad being accessed.

Note: When the keyguard is on, you must turn it off before you can use the phone.

- ▶ Select **Keyguard**.
- ▶ You are asked 'Guard Keypad?'. Press .

You can also set the keyguard directly from the idle screen:

- ▶ Press and hold down .
- ▶ Select **Keyguard**.
- ▶ You are asked 'Guard Keypad?'. Press .

To turn off the keyguard:

- ▶ From idle mode press .
- ▶ You are asked 'Free Keypad?'. Press .

Changing the key volume

The key volume is the volume of the tone made when you press a key.





- ▶ Select **Key Volume**.
- ▶ Use  to move the volume level between 0 and 4.

Changing the key tone

The key tone is the sound made when you press a key.

- ▶ Select **Key Tone**.
- ▶ Select the tone you want.

Choosing the key to use for the answer key

You can choose whether to use any key (except , , ) or just the send key () to answer a call.

- ▶ Select **Answer Key**.
- ▶ Select **Any Key** or **Send Key**.

Phone settings

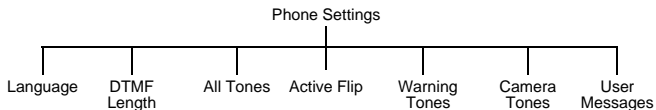

Changing the language

You can change the language that the phone uses for display messages and text entry.

- ▶ Select **Language**.
- ▶ Select **DisplayLanguage** or **Tegic Language**.
- ▶ Select the language.

Note: Tegic language is the language used by T9® text entry. For more information on T9® text entry, see [Entering text on page 36](#).

Changing the DTMF length

DTMF stands for Dual Tone Multi-Frequency. You can send DTMF tones during a conversation to access voice mail, paging and computerized home banking. For example, you may need to enter a number to remotely access voice mail messages.

If the DTMF tones are unsuccessful then the destination of your call may require that the length of the tones be changed, as follows:

- ▶ Select **DTMF Length**.
- ▶ Select **Long** or **Short**.

Turning tones on and off

You can turn on or off all tones or just warning tones.

- ▶ Select **All Tones** or **Warning Tones**.
- ▶ Select **On** or **Off**.

Active flip

If you enable active flip, you can answer a call by opening the phone, end the call by closing the phone and reject a call by pressing the memo/camera shutter key.

- ▶ Select **Active Flip**.
- ▶ Select **On** or **Off**.

Selecting camera tones

The camera tone is the sound the phone makes when you take a picture.

- ▶ Select **Camera Tones**.

Settings

- ▶ Select a tone type.

Note: The camera tone rings each time you take a picture even when **All Tones** is set to **off**.

Editing user messages

The phone contains some standard user messages that you can send to other people. You can edit these messages to suit you.

- ▶ Select **User Messages**.
- ▶ Select the message you want to edit.
- ▶ Edit the message.

Clock

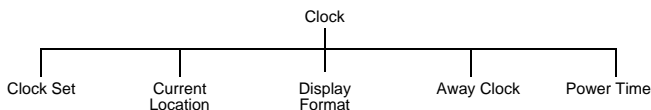

Setting the clock

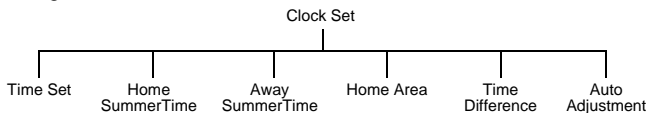

Setting the time

Use this to set the current time and date on your phone.

- ▶ Select **Time Set**.
- ▶ Enter the date (day/month/year).
- ▶ Enter the time (24 hour clock)

Setting summertime

You can set summertime when you are at home or away. When you set summertime, the clock automatically moves on by one hour.

- ▶ Select **HomeSummerTime** or **AwaySummerTime**.
- ▶ Select **On** or **Off**.

Setting your home area

- ▶ Select **Home Area**.
- ▶ Select **World List** to choose a country. Select the country you are in.
- ▶ Select **City List** to choose a city. Select the city closest to your current location.

Auto adjusting the time difference

If you are away, in a country with one time zone, then the time difference can be adjusted automatically.

- ▶ Select **Auto Adjustment**.
- ▶ Select **On**.

The phone gets your location from the local network provider, and adjusts the clock automatically.

Setting the time difference

If you are away, in a country with more than one time zone, then you can set the time difference manually.

- ▶ Select **Time Difference**.
- ▶ Select the difference from your home area.

Changing your location

You can change your location so that the phone's clock automatically adjusts depending on whether you are at home or abroad. All the clocks on the phone display the time of the selected location.

- ▶ Select **Current Location**.
- ▶ Select **Home** or **Away**.

If you select **Away**, you may need to adjust the time difference, so your clock is correct. To do this see Setting the time difference on page 47.

Changing the display format

You can choose how you want the time and date to display.

- ▶ Select **Display Format**
- ▶ Select from the displayed list of date and time formats.

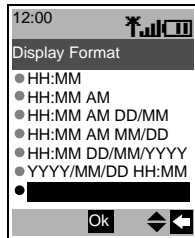

Changing the appearance of the away clock

You can choose how you want the away clock to display.

- ▶ Select **Away Clock**.
- ▶ Select from **Off**, **Large Clock** or **Case Clock**.

Setting the power on and off times

You can use this to set the phone to turn itself on or off automatically at a specified time.





- ▶ Select **Power Time**.
- ▶ Select **--:-- On** or **--:-- Off**.
If times are already set then these times appear before the words **On** and **Off**.
- ▶ Select **--:--** or the existing time.
- ▶ Enter the time you want the phone to power on or off.
- ▶ Set whether these power on/off times are **Repeat Daily**, **Once** or **Disabled**.
- ▶ Press  to save your settings.

Settings

Disabling the power on and off times

- ▶ Select the power on or off time.
- ▶ Select the frequency option.
- ▶ Select **Disabled**.
- ▶ Press  to save your power on or off settings.

Or

- ▶ Highlight the power on or off time.
- ▶ Press  to cycle through **Repeat Daily**(), **Once**() or **Disabled**().
- ▶ Stop at **Disabled**.

Caution: You need to ensure that the times you set will not automatically power on when you are in an aircraft, medical facility etc. See Safety first on page 5.

Call service

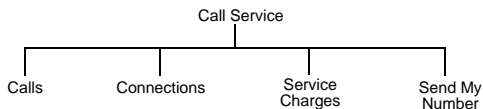

Note: The functions available are SIM dependent.

Calls



Note: The functions available are SIM dependent.

Viewing the length of your last call

- ▶ Select **Calls > Last Call Timer**.
- ▶ The length of your last call is displayed.

Viewing the combined length of all your outgoing or incoming calls

- ▶ Select **Calls > All Calls Timer**.
- ▶ Select **Incoming** or **Outgoing**.
- ▶ The combined length of all your incoming or outgoing calls since the timer was last reset, is displayed.

Once you have seen the total time you can reset the timer:

- ▶ Press **0**.
- ▶ You are asked '**Reset Total Time?**'. Press **0**.
- ▶ Enter the lock code.

Note: The lock code is preset to 0000. For security you should change this to a four figure number that you can remember, see Changing the phone lock code on page 53.

Checking the status of call waiting, caller's id and withhold id

Note: This is network dependent .

- ▶ Select **Calls**.
- ▶ Select **Call Waiting, Caller's ID** or **Withhold ID**.
- ▶ The status is displayed.

For **Call Waiting**, you can change the status:

If **Call Waiting** is disabled and you want it enabled, select **Menu > Enable**.

If **Call Waiting** is enabled and you want it disabled, select **Menu > Disable**.

Connections

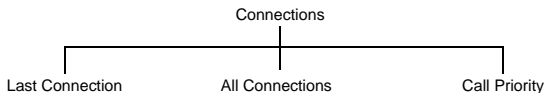

Viewing details of your last connection

Select **Connections > Last Connection**.

The time and data transfer details are displayed.

Viewing the combined details of your previous connections

Select **Connections > All Connections**.

The combined length of all your connections since the connection was last reset, is displayed.

Once you have seen all the details you can reset the total time and data:

- ▶ Press **0**.
- ▶ You are asked '**Reset Total Time and Data?**'.
- ▶ Press **0**. Enter the lock code.

Note: The lock code is preset to 0000. For security you should change this to a four figure number that you can remember, see Changing the phone lock code on page 53.

Settings

Allowing incoming calls during data transfer

With this enabled, you can transfer data and accept incoming calls on your phone. With this disabled, you cannot answer incoming calls while you are transferring data.

- ▶ Select **Connections > Call Priority**.
- ▶ Select **On** or **Off**.

Service charges

Note: This is SIM , Service Provider and network dependent .

To maintain control over the cost of calls that you make, you can set the phone to restrict its use to a specified number of units.

Setting the unit price

First you need to enter a price per unit. This is the amount that your Service Provider charges for one unit of call time.

- ▶ Select **Service Charges > Price/Unit**.
- ▶ Enter your PIN2.
- ▶ Enter the currency unit (maximum 3 characters).
- ▶ Enter the unit price.

Setting the maximum unit level

Use this to set the maximum cost of the calls that you can make.

- ▶ Select **Service Charges > Max Cost**.
- ▶ Select **Menu > Edit**.
- ▶ Enter your PIN2.
- ▶ Enter the maximum number of units (the corresponding cost is displayed).

Note: The duration of one unit may vary during the day at peak and off-peak times. The call charge information may not be an accurate reflection of the tariffs charged by your Service Provider.

Disabling the maximum unit level

Use this to disable your maximum cost setting.

- ▶ Select **Service Charges > Max Cost**.
- ▶ Select **Menu > Disable**.
- ▶ Confirm that you want to disable this setting.
- ▶ Enter your PIN2.

Setting a warning level

You can set a warning to indicate that you have almost reached your maximum cost.

Note: This is SIM dependent .

- ▶ Select **Service Charges > Warning at**.
- ▶ Enter a value in units at which you want the warning to sound.

Viewing the remaining cost

You can see how many units you have left before you reach your maximum cost level.

- ▶ Select **Service Charges > Cost Left**.

Viewing the used cost

You can see how many units you have used.

- ▶ Select **Service Charges > Call Meter**.

Resetting the used cost

Use this to reset your used cost.

- ▶ Select **Service Charges > Call Meter**.
- ▶ Select **Reset**.
- ▶ Confirm that you want to reset this setting.
- ▶ Enter your PIN2.

Sending your number

Note: This is network dependent .

If your network supports this function, you can decide whether you want your phone number to be sent when you make a call.

Note: You must be registered with a service provider before you can choose to send your number.

- ▶ Select **Send My Number**.
- ▶ Select from **Network Set, On** and **Off**.

If you select **Network Set**, your network's default setting is used.

Call divert

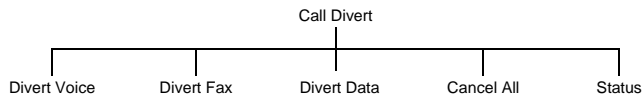

Setting and cancelling diverts

To set diverts for specific call types:

- ▶ Select the type of call you want to divert.
- ▶ Select **Set**.
- ▶ Select from **All Calls**, **When Busy**, **When No Reply** and **When Unreachable**.
- ▶ Enter the number to divert to.

To cancel diverts for specific call types:

- ▶ Select the type of call you want to cancel the divert on.
- ▶ Select **Cancel**.
- ▶ Select from **All Calls**, **When Busy**, **When No Reply** and **When Unreachable**.

To cancel all diverts:

- ▶ Select **Cancel All**.
- ▶ Confirm that you want to cancel all the diverts you have set.

Viewing the divert status

- ▶ Select **Status**.
- ▶ Use  to scroll through the list, only one item at a time appears on the screen.

Security

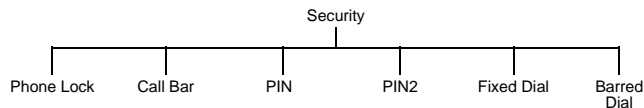

Setting and cancelling the phone lock

Note: You can also set the phone lock by holding down  on the idle screen, then following the instructions below.

When the phone lock is set you can only use the phone to receive incoming calls and to make emergency calls.

- ▶ Select **Phone Lock > On/Off > On**.
- ▶ Enter the lock code.

The lock icon (🔒) is displayed on the screen.

When the phone lock is on you have to enter the lock code from the idle screen before you can use the phone.

Note: The phone lock code is preset to 0000. For security, you should change this to your own four-figure number, see Changing the phone lock code on page 53.

To cancel the phone lock:

- ▶ Select **Phone Lock > On/Off > Off**.
- ▶ Enter the lock code.

Changing the phone lock code

You can change the phone lock code to a four figure number that you find easy to remember.

- ▶ Select **Phone Lock > Change Code**.
- ▶ Enter the current phone lock code.
- ▶ Enter the new phone lock code.
- ▶ Verify the new phone lock code.

Setting and cancelling call bar

Call barring restricts certain types of incoming and/or outgoing calls, using a password provided by your Service Provider. When you check the status of the Call Bar, your phone must be registered with a network. You can set call barring for voice, fax and data calls.

- ▶ Select **Call Bar**.
- ▶ Select the type of call that you want to bar.
- ▶ Select **Set** or **Cancel**.
- ▶ Select when you want to bar the calls.
- ▶ Enter the password, provided by your Service Provider.

Note: You can change your password to something that you find easy to remember, see Changing the password on page 54.

To cancel all the current call bars:

- ▶ Select **Call Bar > Cancel All**.
- ▶ Enter the password.
- ▶ Confirm that you want to cancel all the set call bars.

Viewing the call bar status

You can see whether you have any call types barred.

- ▶ Select **Call Bar > Status**.
- ▶ Use  to scroll through the list, only one item at a time appears on the screen.

Changing the password

You can change the password to something that you find easy to remember.

- ▶ Select **Call Bar > Password**.
- ▶ Enter the password, supplied by your Service Provider.
- ▶ Enter the new password.
- ▶ Verify the new password.

Enabling and disabling PIN and PIN2

The PIN protects your phone against unauthorized use. If you enable the PIN, you have to enter it every time you turn on the phone.

You need PIN2 to set fixed dial numbers.

Your PIN and PIN2 are supplied by your Service Provider.

Note: If you enter the PIN or PIN2 incorrectly three times, the phone will lock and you will need to enter the PUK or PUK2 code. If you enter the PUK or PUK2 code incorrectly ten times, your phone will no longer operate. All information stored in the SIM will be lost, and you will need to replace the SIM. Contact your Service Provider for the PUK and PUK2 codes. Contact your Service Provider for more details.

- To enter PUK code for PIN, enter ****05*** you will then be prompted to enter the PUK code, then follow the on-screen instructions.
- To enter PUK2 code for PIN2, enter ****052*** you will then be prompted to enter the PUK2 code, then follow the on-screen instructions.

If the PUK/PUK2 code is entered incorrectly 10 times, the SIM will cease to operate. All information stored in the SIM will be lost and the SIM will need to be replaced. Contact your Service Provider for more details.

To enable and disable PIN:

- ▶ Select **PIN**.
- ▶ Select **Enable/Disable**.
- ▶ Select **On** or **Off**.

- ▶ Enter the **PIN**.

To enable and disable PIN2:

- ▶ Select **PIN2**.
- ▶ Enter the **PIN2**.

Changing the PIN

You can change the PIN to an eight figure number that you find easy to remember.

- ▶ Select **PIN**.
- ▶ Select **Change Code**.
- ▶ Enter the PIN.
- ▶ Enter the new PIN.
- ▶ Verify the new PIN.

Note: You can only change the PIN when it is enabled.

Note: PIN2 is SIM dependent 

Enabling and disabling fixed dial

Fixed dial is part of the **Contacts List**, but with added security. When you enable fixed dial:

- You can only dial numbers that are in the fixed dial store
- If you manually dial a number, it must match one in the fixed dial store.
- If you store, edit or delete a phone number, you have to enter your PIN2.

To enable or disable fixed dial:

- ▶ Select **Fixed Dial**.
- ▶ Select **On** or **Off**.
- ▶ Enter your PIN2, provided by your Service Provider.

When you enable fixed dial, in the **Contacts List** you can only browse the numbers that are in the fixed dial store.

Enabling and disabling barred dial

When you enable barred dial you can no longer dial the numbers that you entered as barred dial numbers. You can use this to stop certain numbers being dialed.

To enable or disable barred dial:

- ▶ Select **Barred Dial**.
- ▶ Select **On** or **Off**.
- ▶ Enter your password.

Note: Barred Dial is SIM dependent 

Network

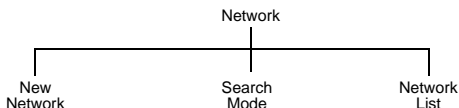

Changing to a new network

When you are not in your home country or region, you may be able to use a network that you are not directly subscribed to. This is called *roaming*.

Use the options on the **Network** menu to select a network that is available in your current location.

- ▶ Select **New Network**.
- ▶ Select a new network.

An X appears in the information area if you cannot register with the selected network.

Search mode

You can set the **Search Mode** to **Automatic** or **Manual**. When the **Search Mode** is **Manual**, the phone only uses the selected network. If coverage is lost, you need to select another network. When the **Search Mode** is **Automatic**, the phone automatically reselects a new network to maintain network availability.

Network list

In **Automatic Mode**, the phone uses the **Network List** to find a new network. The location numbers in the **Network List** show the search priority. You can change the list as follows:

Insert stores a new network in the currently displayed location, and moves other networks down.

Edit overwrites the old network with a new one.

Delete deletes the currently displayed network.

Ok selects the currently displayed network.

Defaults

Use this to return your personal settings to their factory default. You cannot return the **Phone Lock**, **Language** and **Clock** to their default settings.





Contacts list

Use the **Contacts List** menu to store a person's phone numbers, e-mail addresses, company name, picture and other information. You can also set up how your contacts list is organised and displayed.

Browse

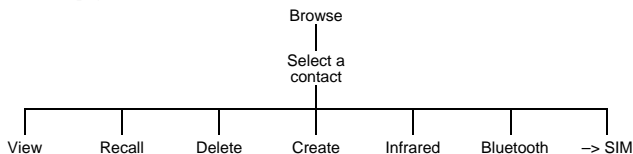
This menu only applies to contacts stored on your phone. For contacts stored on the SIM see SIM on page 64.



Note: When you create or edit any of your entries, you must press  to save your changes, or they will be lost.

View. Displays all the details for the entry you selected. You need to scroll down the screen to see all the information.

Recall. Displays the phone number for the entry you selected. You can either call it or change it. To call it press .

Note: Unless the phone number is stored in **Contacts List**, the phone will automatically go back to Idle mode.

Delete. Deletes the entry.

Create. Creates a new entry in the **Contacts List**.

Infrared. Sends the details of the current entry to another device via the infrared port. See Send your details to an infrared device on page 115.

Bluetooth. Sends the details of the current entry to another Bluetooth® device. See Send your details to a Bluetooth® device on page 115.

Note: To receive a contact entry from another infrared or Bluetooth® device use **ReceiveObject**, see Receive object on page 124.

-> **SIM.** Copies the details of the current entry to the SIM.



















Create

Note: When you create or edit any entries, you must remember to press  to save your changes, or they will be lost.

Creating a new contact

- ▶ Select **Create**.
- ▶ Select an item.
- ▶ Enter the data using the keypad, or select an item from the list available.

For each contact you can enter:

Item	Number of characters
 First name	16
 Last name	16
 Home number	40
 Work number	40
 Mobile number	40
 Other number	40
 Home e-mail	80
 Work e-mail	80
 Other e-mail	80
 URL	80
 Title	16
 Company	16
 Note	32
 Photo	Select a picture from the list or take a picture with the camera
 Group name	Select a group from the list.
 Ring type	Select a tone from the list
 Vibration alert	Select a vibration type from the list.
 Case screen colour	Select a colour from the list.
 Location	3 (up to 500 locations)

When you have entered all the details, press  to save the contact. The contact you created is saved into Phone. You can copy it to SIM.

Note: You need to enter one of which is name, phone number or e-mail address to save. Location is the location number in your **Contacts List**. If you put a contact in a group which has a ring type, case screen colour and vibration alert, then these options are not available for the individual contact.

You can only see the contact data in Phone when pressing  from idle mode. If you wish to see a contact data in SIM, you need to copy it from SIM to Phone.

Entering DTMF digits in a phone number

You can enter DTMF digits at the end of a phone number, so that these numbers are automatically sent after the main phone number.

- ▶ Enter the phone number.
- ▶ Press and hold  until a P is displayed at the end of the phone number.
- ▶ Enter the DTMF digits, for example, the number to access voice mail messages.

When you call this number the DTMF tones will be sent after 3 seconds.

Entering a picture

You can choose from **Camera** and **Select**.

Choose **Camera** to take a picture with the phone's camera:

- ▶ Select **Camera**.
- ▶ Take the picture.
- ▶ Press  to return to the **Contact**.

Choose **Select** to select a picture from your **Data Folders**:

- ▶ Select **Select**.
- ▶ Choose the folder contain the picture you want to use and press **Open**.
- ▶ Select the picture and press **Select**.

'Wild' numbers

Wild numbers are spaces that you can store in a phone number. You must fill the wild numbers before you can dial that phone number. You can use wild numbers in conjunction with fixed dial, to, for example, restrict calls to a specific area by storing the area code then adding the remainder of the number when it is recalled.

To enter a wild number:

While entering a phone number, press and hold , until _ is displayed.

When you recall this phone number, enter the required number to replace the wild number.

Voice dial

With voice dial you can save a number using your voice. You can then dial the number by saying the name that you want to call.

Creating a voice dial entry

- ▶ Select **Voice Dial**.
- ▶ Select **Add**.
- ▶ Select a contact.
- ▶ Select **Recall**.
- ▶ Select **Ok**.
- ▶ Hold the phone about 8 inches away from your mouth.
- ▶ Speak clearly into the microphone to record the required name.

For each entry you are prompted to record the name a second time, so that the phone recognizes your voice and intonation.

When you have finished recording, the display shows whether or not the recording was successful. If the recording failed, you need to try again. You can try as many times as you need to.

Note: Each recording is short, so be ready to speak soon after initiating the recording.

Recalling a voice dial entry

- ▶ From idle mode press and hold **⓪** or **⓪**.
- ▶ Say clearly the name that you want to recall.
- ▶ Press **☎** to call the number.

dialing a voice dial entry

You can set up voice dial to dial a voice dial number directly from idle mode, so you don't have to press **☎** to call the number.

- ▶ Select **Settings**.
- ▶ Select **Voice Dial**.
- ▶ Select **On/Off**.
- ▶ Select **ON**.

To turn it off select **Off**.

Note: Use voice dial to make calls from your Bluetooth® headset or car kit. Voice dial recordings must be loud to ensure that confirmation is audible when using some car kits.

Editing a voice dial entry

- ▶ Select **Voice Dial**.
- ▶ Select an entry.
- ▶ Select from **Add**, **Play** and **Delete**.

Add. Add a new **Voice Dial** entry.

Play. Listen to the recording for the selected entry.

Delete. Delete the selected entry.

Groups

From the **Groups** menu, you can set up groups of contacts. You can use groups to collect together types of entries, for example, business, friends and family. You can give each group a suitable title, for quick access to the entries.

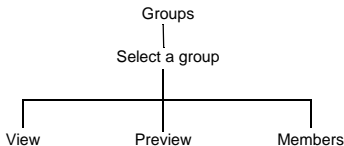

Note: If you already have ring type, vibration alert and case screen colour set for an individual that you add to the group, then the group's settings are used in preference to those set for the individual.

Creating a group

- ▶ Select a preset group name or one of the available user group names from the list.
- ▶ You can enter a name, ring type, vibration alert and case screen colour.

Note: If you already have ring type, vibration alert and case screen colour set for an individual that you add to the group, then the group's settings are used in preference to those set for the individual.

Viewing a group

- ▶ Select the group on the list.
- ▶ Select **View** from the menu.

From this view you can then edit the group settings:

- ▶ Select the item that you want to edit.
- ▶ Select **Edit**.
- ▶ Make your changes.

Contacts list

- ▶ Select **Ok** to make your changes or **Cancel** to revert to the original.

You can revert to the original settings by selecting **Reset**.

Previewing a group

This simulates an incoming call, so that you can review your settings and see if they are what you want.

- ▶ Select a group.
- ▶ Select **Preview** from the menu.

You can then adjust your settings using **View**.

Adding and removing members

You can add or remove numbers.

To add a new member:

- ▶ Select the group on the list.
- ▶ Select **Members** from the menu.
- ▶ Select **Add**.
- ▶ Select a contact from your list.

Or

- ▶ Highlight the group on the list.
- ▶ Press .
- ▶ Select **Add**.
- ▶ Select a contact from your list.

To remove a member:

- ▶ Select the group on the list.
- ▶ Select **Members** from the menu.
- ▶ Highlight a contact.
- ▶ Select **Remove** to remove this contact from the group.

Or

- ▶ Highlight the group on the list.
- ▶ Press .
- ▶ Highlight a contact.
- ▶ Select **Remove** to remove this contact from the group.

Settings

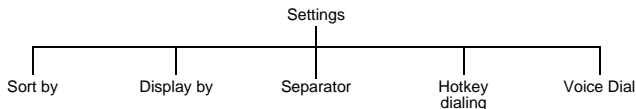

Setting how to sort or search entries

You can choose how to sort and search the entries in your **Contacts List**.

- ▶ Select **Sort by** or **Display by**.
- ▶ Select **First Name** or **Last Name**.

Setting how to display entries

You can choose how to display the entries in your **Contacts List**.

- ▶ Select **Separator**.
- ▶ Select **Space** or **Comma**.

Enabling and disabling hotkey dialing

With hotkey dialing, you can press and hold the digit key that relates to a location number to call contacts on your **Contacts List**. For example, to call the contact in location 3 of your **Contacts List**, press and hold .

To enable hotkey dialing, select **Hot Key dialing**, then select either **SIM Phonebook** or **Mobile Phonebook**.

To disable hotkey dialing, select **Hot Key dialing** > **Off**.

Enabling and disabling voice dialing

With voice dialing, you can call a contact by speaking into the microphone.

- ▶ Select **Voice Dial**.
- ▶ Select **On** or **Off**.

To set up voice dial numbers see *Creating a voice dial entry* on page 60.

SIM

This shows the contacts stored on your SIM.

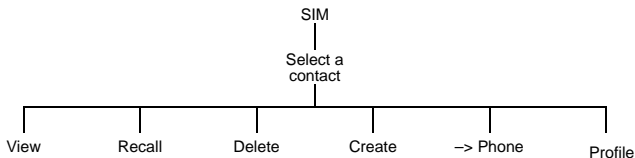

Note: When you create or edit any of your entries, you must press  to save your changes, or they will be lost.

View. Displays all the details for the entry you selected.

Recall. Displays the phone number for the entry you selected. You can either call it or change it. To call it press .

Delete. Deletes the entry.

Create. Creates a new entry in the **Contacts List**.

Note: For a SIM entry you can only enter a name, phone number and location.

-> Phone. Copies the details of the current entry to the phone.

Profile. Displays the entry's profile.

Creating fixed dial number entries

Note: Before you can create a fixed dial number entry, you have to enable Fixed Dial (see Enabling and disabling fixed dial on page 55).

Fixed dial is part of the **Contacts List**, but with added security. When you enable fixed dial:

- You can only dial numbers that are in the fixed dial store
- If you manually dial a number, it must match one in the fixed dial store.
- If you store, edit or delete a phone number, you have to enter the PIN2, provided by your Service Provider.

You enter the contact details using the **Create** option on the **SIM** menu. When you save the entry you have to enter your PIN2. The number is stored in the fixed dial store on your SIM.

Creating barred dial number entries

Note: Before you can create a barred dial number entry you have to enable Barred Dial (see Enabling and disabling barred dial on page 55).

Note: Barred Dial is SIM dependent 

When you enable barred dial you can no longer dial the numbers that you entered as barred dial numbers. You can use this to stop certain numbers being dialed.

You enter the contact details using the **Create** option on the **SIM** menu. When you save the entry you have to enter your password.

Storage

This shows the amount of space you have used on your SIM and your phone. Use  to move between the two.

You can copy all the SIM contacts to the phone or copy all the phone contacts to the SIM:

- ▶ Select **Menu > Copy All**.
- ▶ Select **SIM to phone** or **Phone to SIM**.

You can delete all the SIM contacts or all the phone contacts:

- ▶ Select **Menu > Delete All**.
- ▶ Select **SIM Contacts** or **Phone Contacts**.



Games

The games that are on your phone are **network dependent**. If you have four games listed then you have embedded games and should follow the instructions in the Embedded games section.

Embedded games

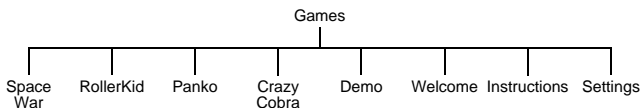

To play the embedded games, select the required game, then follow the on-screen instructions.

Demo

Select this to see a demonstration of a game.

Welcome

Select this to read the welcome screen.

Instructions

Select this to see general instructions for playing the games.

Settings

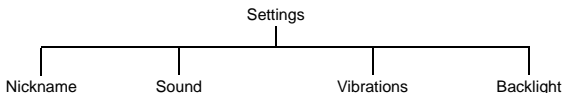

Nickname

Use this to create a name to use when you play games. When you first select this item, it displays **No nickname**. Use  to delete the existing text, then enter your nickname.

Sound

Use this to set the sound level for your games. You can select from **Off**, **Low**, **Medium** and **High**.

Vibrations

If you turn vibrations on, the phone vibrates when a target is hit in the game. You can select from **On** and **Off**.

Backlight

Use this to set your key backlight. You can select from **Off**, **On 30s** and **Always on**.

Note: If you select **Always on**, this may affect the talk and standby time of your battery.



Browser

Use the Browser menu to access Internet services supported by the network, such as news, weather reports and sport.

Server list

Before you can access the Internet, your SIM must be data enabled and the configuration information must be entered.

Note: The configuration information may have been pre-programmed by your Service Provider. If you modify these settings, your browser may no longer work. Once you have set up a server you need to select the new server and select **Set** to activate the new setting.

You can manually set up five servers on your phone.

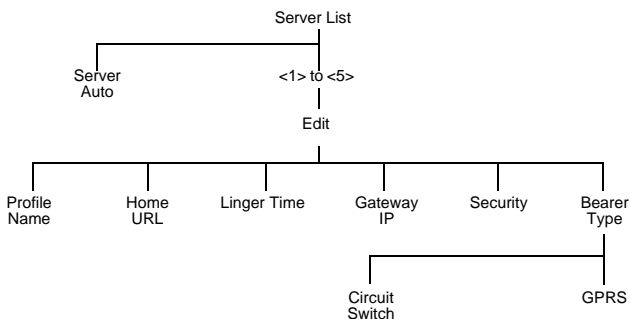

Select **Circuit Switch**, select **Set**, then select **Edit** to set:

- Digital Dial #
- Analogue Dial #
- Circuit Type. Select from **Digital** and **Analogue**.
- User ID
- User Password

Select **GPRS**, select **Set**, then select **Edit** to set:

- Access Point Name
- User ID
- User Password
- Authentication. Select from **Normal**, **Encrypted** and **None**.

Home page

To start the browser, select **Home Page** (to start the browser from idle mode press the  key).

This opens the browser at your Service Provider's home page. This is recalled from the cache each time you start the browser. The cache is the phone's memory where pages that you have previously downloaded are stored.

The phone remains off line (i.e. not connected to a server) when it recalls pages from the cache.

The browser menu

The browser has its own menu, which you use when an Internet page is currently displayed, either on line or off line. To access this menu press .

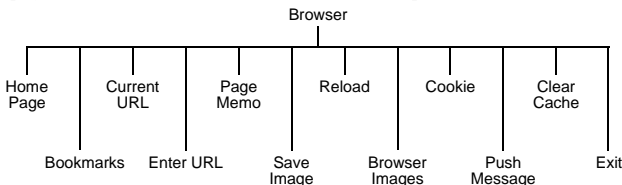

Home Page. Displays the page defined by your Service Provider.

Bookmarks. Saves the current page as a bookmark, so you can return to it another time.

Current URL. Displays the current URL.

Enter URL. Enter the address of the URL that you want to go to.

Page Memo. Saves the currently displayed page.

Save Image. Saves the currently displayed image.

Reload. Reloads and updates the current page.

Browser Images. Disables images, to display a page more quickly.

Cookie. Enable, disable or delete cookies.

Push Message. View all your push messages.

Clear Cache. Deletes the page(s) in the cache, and displays the **Home Page**.

Exit. Stops the browser.

Navigating pages

- ⬆ Scroll up one line at a time. Focus on a link if there is one.
- ⬇ Scroll down one line at a time. Focus on a link if there is one.
- ⬅ Moves the focus to the left.
If there is a right arrow icon in the left selection area of the screen, this key moves the focus to the right side in the next upper line.
- ➡ Moves the focus to the right.
If there is a left arrow icon in the right selection area of the screen, this key moves the focus to the right side in the next lower line.
- ☑ If there is a tick icon in the right selection area of the screen, this key opens a new menu.
- ☰ Display the browser menu.
- 🔗 Follow a highlighted link.
- 🖼 indicates an image that cannot be displayed.
- 🌐 indicates on line browsing GPRS mode (non secure).
- 🔒 indicates on line browsing GPRS mode (secure).
- 🌐 indicates on line browsing CSD mode (non secure).
- 🔒 indicates on line browsing CSD mode (secure).

Bookmarks

This lists the bookmarks that you have stored. Select a bookmark from the list to go directly to that page.

Adding a bookmark

- ▶ While viewing content, select **Bookmarks** from the **Browser** menu.
- ▶ Select **<Register>**.

Deleting bookmarks

- ▶ While viewing content, select **Bookmarks** from the **Browser** menu.
- ▶ Press  to select **Menu**.
- ▶ Select from **Delete This**, **Delete Any** and **Delete All**.

Renaming a bookmark

- ▶ Select **Bookmarks** from the **Browser** menu.
- ▶ Select **Menu > Edit Title**.
- ▶ Press and hold  to delete the current name.
- ▶ Enter the new name.

Grouped bookmarks

If you have set your bookmarks to display in groups (see Bookmarks on page 72), then you can highlight a group and select **Menu**, to make changes to that group. The options are:

Edit Title. Change the title of the group.

Display. Select **List** to display your bookmarks as one list.

Delete All. Delete all the bookmarks in that group.

Enter URL

Use this to enter a URL to go to a known site.

Page memo

Use this to view a previously saved page.

Push message

Push messages are SMS messages that the phone receives that relate to the browser. Use this to view the received messages.

Note: WAP push message will be displayed on Idle mode, or launcher mode while you are in a WAP browse. The display will not change on the modes other than Idle mode or launcher mode while you are in a WAP browse. However, WAP push message can be viewed by selecting **Browser > Push Message**.

Browser settings

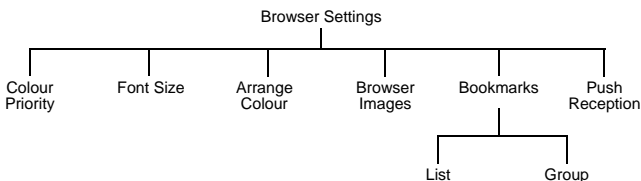

Use this to customise the browser interface.

Setting the colour priority

You can choose whether to use your colour settings, or those set by the Internet site that you are viewing.

- ▶ Select **Colour Priority**.
- ▶ Select from **Prefer Content** and **Prefer User's**.

Browser

Setting the font size

You can choose the font size of the text.

- ▶ Select **Font Size**.
- ▶ Select from **Large**, **Standard** and **Small**.

Arranging the colour

You can set the colours for your background, text, visited site and new site.

- ▶ Select **Arrange Colour**.
- ▶ Select from **Background**, **Text Colour**, **Visited Site** or **New Site**.
- ▶ Select a colour.

Enabling and disabling the browser images

If you disable browser images, pages display more quickly.

- ▶ Select **Browser Images**.
- ▶ Select from **On** and **Off**.

Bookmarks

You can choose whether to have one list of bookmarks, or whether to group your bookmarks.

- ▶ Select **Bookmarks**.
- ▶ Select from **List** and **Group**.

If you select **Group**, you can set up five different groups to store your bookmarks.

Enabling and disabling push reception

If you enable **Push Reception**, you will receive all the push messages sent by your Service Provider.

- ▶ Select **Push Reception**.
- ▶ Select from **On** and **Off**.

Cookie

Cookies are information saved about a site to allow you to access it more quickly when you return to it.

If you want the phone to save cookies, select **Cookie > Enable > On**.

If you do not want the phone to save cookies, select **Cookie > Enable > Off**.

To delete an existing cookie, select **Cookie > Delete**.

Last status

This displays the status of the last site that you visited. If your browser stops working, you may need this information to find the problem.



Camera

Note: Before using the camera it is recommended to set the date and time. The date and time are reflected on the file name. See Setting the clock on page 46.

You can take pictures with the built-in camera, and send them in multimedia (MMS) e-mail messages, or use them as wallpaper.

You can also send the pictures in **Data Folders** using Infrared and Bluetooth®.

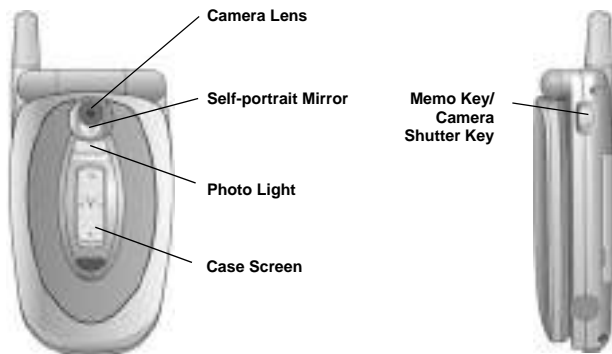

Changing to camera mode

When the phone is opened:

- ▶ Select camera from the main menu.

or

- ▶  from Idle mode.

Note: Available only by setting the function in the Shortcut key.

When the phone is closed:



- ▶ Press and hold Memo Key/Camera Shutter Key.

Leaving camera mode

To leave camera mode press  to return to idle mode.

Taking a picture

- ▶ When you are in camera mode, move the phone around until you can see the image you want on the preview screen.
- ▶ Press  to capture the image.

If you decide that you do not want the image that you have taken, you can press  or  and select **Delete**.

Taking a self-portrait

You can take a self-portrait using the shutter button on the side of the phone.

- ▶ Ensure that the phone is in camera mode.
- ▶ Close the phone.
- ▶ View the image in the self-portrait mirror.
- ▶ Press the shutter button on the side of the phone.

You can use this image in the same way as any other picture that you take with the camera.

Note: The digital camera built into this phone uses a C-Mos sensor, leaving the phone in extremely warm conditions may affect the quality of pictures taken at that time. Do not leave the phone with the Camera facing direct sunlight to avoid impairing the camera performance.

If the Camera is left in the preview mode or a captured picture is displayed the phone will automatically return to Idle mode after 3 minutes. However, If you enter **Camera** menu from Main menu, the phone returns to main menu.

Saving a picture

When you take a picture, it is automatically given a default name and stored in a data folder. You can change the name of the picture using **Rename**, see Renaming the picture on page 77.

Incoming calls when in camera mode

If you receive an incoming call while you are in camera mode, the phone leaves camera mode and switches to the incoming call. If a captured image is on the preview screen, it is saved in **My Folders > My Pictures**. If you want to use the image when you have completed your call, go to **My Folders > My Pictures** and select the image.

Using your Picture

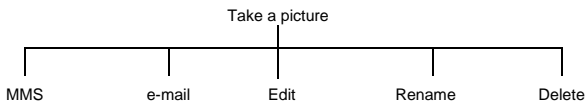

Once you have taken a picture, press to access the menu.

Sending the picture in a multimedia or e-mail message

Select **MMS** or **e-mail**.

A multimedia or e-mail message is opened, with the picture already embedded or attached.

Editing the picture

When you have finished editing the picture, you must press to save your changes.

- ▶ Select **Edit**.
- ▶ Press .

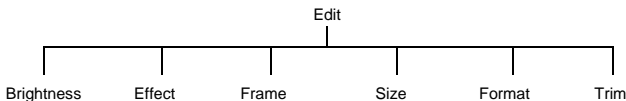

Changing the brightness

- ▶ Select **Brightness**.

Camera

- ▶ Press **◀** to make it lighter or **▶** to make it darker.

Changing the effect

Use this to change your picture's colours by using an effect.

- ▶ Select **Effect**.
- ▶ Select from **Sepia**, **Monochrome** and **Negative**.

Selecting a frame

Use this to enhance your picture, by adding one of the predefined frames.

- ▶ Select **Frame**.
- ▶ Select from a list of frames. You can preview the frame by highlighting it then pressing **○**.

Changing the size

Use this to make your picture larger or smaller.

- ▶ Select **Size**.
- ▶ Choose **Width** or **Height**.
- ▶ Select **Edit**.
- ▶ Enter the percentage by which you want to change the size.
- ▶ Press **○** and select **Ok**.
- ▶ After completing to change the size, press **○**.
- ▶ Select **Ok**.

Note: This does not cut your image, it compresses and/or stretches it. To cut your image, use **Trim**.

Changing the format

- ▶ Select **Format**.
- ▶ Choose from **JPEG Fine**, **JPEG Normal**, **JPEG Economy** and **PNG**.

JPEG Economy produces a small file but with a low resolution.

JPEG Normal produces a file which is acceptable for most uses.



JPEG Fine and **PNG** produce large files with high resolution.

Trimming your picture



Use this to select and save just a small part of your picture.

- ▶ Select **Trim**.
- ▶ Use **◀** to increase and decrease the size of the box to include just the part of the picture that you want.
- ▶ First adjust up and left, then press **○** to adjust down and right. The white corner of the box indicates the directions that you can go.
- ▶ When you have the selection you want, press **○** to select the area.
- ▶ Press **○**.



Renaming the picture

- ▶ Select **Rename**.
- ▶ Use  to remove the existing text.
- ▶ Enter the new text.
- ▶ Press .
- ▶ Select **Ok** to save your changes or **Cancel** to revert to the old name.

Deleting the picture

- ▶ Select **Delete** or press .
- ▶ Press  to confirm, or  to cancel.



Close up picture

When the image is on the preview screen, press  to see a close up picture. This zooms in on the center of the image. Press  to return to the original image.

Brightness adjustment

You can set the brightness of an image both before and after taking the picture. The brightness can be increased or decreased by two levels.

Changing brightness while taking a picture

When the image is on the preview screen, press  to make it lighter or  to make it darker. The brightness icon at the top of the screen changes to show how much lighter or darker you have made the image.

Changing brightness after taking a picture

See Changing the brightness on page 75.

Preview screen menu

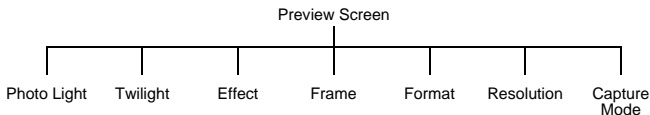

These are all set up using the same basic method:

- ▶ When the required image is shown in the preview screen, press .
- ▶ Select the required option.

Camera

- ▶ Select the required setting.
- ▶ Press  to leave the menu.

Photo light

Turns on a light on the front of the phone.

Twilight

Turn **Twilight** on when taking pictures in low light conditions.

Effect

With **Effect** you can choose from **Off**, **Sepia**, **Monochrome** or **Negative**.

Frame

This places a border round the image. You can preview the frame by highlighting it then pressing .

Format

With **Format** you can choose the format for saving your image.

JPEG Economy produces a small file but with a low resolution.

JPEG Normal produces a file which is acceptable for most uses.

JPEG Fine and **PNG** produce large files with high resolution.

Resolution

With **Resolution** you can choose the resolution for your image. You can choose from **132 x 176** and **288 x 352**. The default is **132 x 176**.

If you select **288 x 352** then the following options are not available:

- Close-up picture: Zoom in and out in preview
- **Frame**
- PNG format preview.

Also:

- **Multi-shot** is available but the picture resolution in this mode is 132 x 176.
- The close up icon on the preview is replaced by the CIF icon.
- When you take a picture then select **Edit**, the editor reduces the picture to 132 x 176. A warning message: **This will reduce the picture size. Continue?** appears on the screen, press  to continue editing.

Capture mode

With **Capture Mode** you can choose from:

Single Shot takes a single picture.

Multi Shot captures images at 1 second interval while you hold  down, to a maximum of six images.

Self Timer delays the taking of an image.

Remote takes a picture automatically upon receiving a call while you are away from the phone.

- ▶ Select **Remote** for a remote control picture taking.
- ▶ When you receive an incoming call, the image on the screen is captured automatically.
- ▶ After taking a picture, the phone return to Preview Screen.



Messaging

From the Messaging menu you can send and receive MMS, SMS and e-mail messages.

The nine menus are as follows:



Settings

- 1 MMS
- 2 SMS
- 3 e-mail



Inbox

- 1 MMS
- 2 SMS
- 3 e-mail



Broadcasts

- 1 Receive
- 2 Message List
- 3 Topics
- 4 Languages



Voice Mail

- 1 Voice Mailbox



Create

- 1 MMS
- 2 SMS
- 3 e-mail



e-mail



Data Folders

- 1 My Pictures
- 2 My Sounds
- 3 My Themes
- 4 User 1 - 5



Outbox

- 1 MMS
- 2 SMS
- 3 e-mail



SMS Chat

MMS

MMS stands for Multimedia Message Service. With MMS you can attach images and music to text messages. The recipient can play the images and music as a slide show.



Settings

Use **Settings** to set up MMS to suit your requirements.

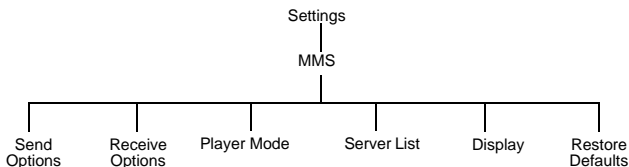

Configuring MMS

Note: Your MMS settings may have been pre-configured by your service provider. MMS may not work if you change these settings.

You must configure your MMS before you can send or receive MMS messages. You can create up to three server profiles on the phone.

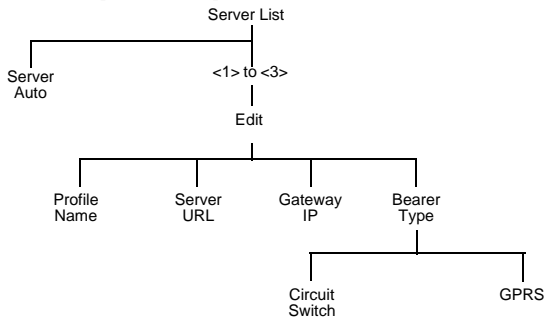

Select **Circuit Switch**, select **Set**, then select **Edit** to set:

- Digital Dial #
- Analogue Dial #
- Circuit Type. Select from **Digital** and **Analogue**.
- User ID
- User Password

Select **GPRS**, select **Set**, then select **Edit** to set:

- Access Point Name
- User ID
- User Password
- Authentication. Select from **Normal**, **Encrypted** and **None**.

Note: Once you have set up a server you need to select the new server and select Set to activate the new setting.

Messaging

Setting send options

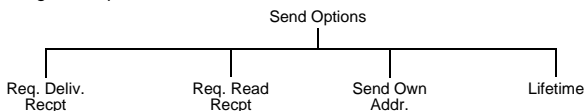

You set send options to determine what happens to messages that you send.

Req. Deliv. Recpt. Decide whether or not you want confirmation that your message has been delivered. Select **Yes** or **No**.

Req. Read Recpt. Decide whether or not you want confirmation that your message has been read. Select **Yes** or **No**.

Send Own Addr. Choose whether or not to let the recipient see your address. You can only show your address if your service provider allows. Select **Show** or **Hide**.

Lifetime. Set the time limit for the lifetime for sent messages. Select **Maximum** or **Manual**. If you select **Manual**, you need to enter the number of hours (1 - 99).

Setting receive options

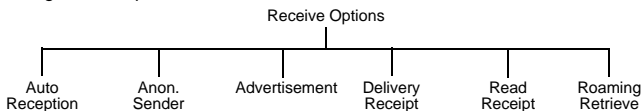

When you have selected a message type, you can select how you want to deal with it.

Message type	Options
Auto Reception	Auto Retrieve, Ask
Anon. Sender	Accept, Reject
Advertisement	Accept, Reject
Delivery Receipt	Permit, Reject
Read Receipt	Permit, Reject
Roaming Retrieve	Ask, Pending, Off

Setting the player mode

You can decide whether to play attached Picture, Text and Sound manually or automatically.

- ▶ Select **Player Mode**.
- ▶ Select **Automatic** or **Manual**.

Setting what is displayed

You can decide whether to display the subject or the address in your inbox and outbox.

- ▶ Select **Display**.
- ▶ Select **Inbox** or **Outbox**.
- ▶ Select **Subject** or **Address**.

Restoring defaults

To cancel all the options that you have set select **Restore Defaults**.

Create



Use **Create** to create an MMS message.

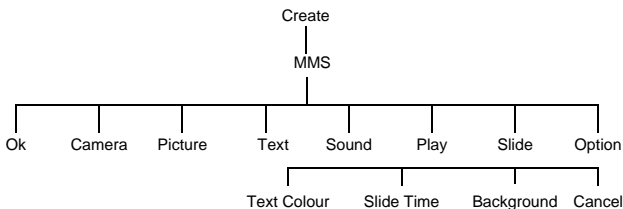

- ▶ Select **Create > MMS**.
- ▶ Press **○**.
- ▶ Select an item from the menu that you want to enter.
- ▶ When your message is complete, press **○** and select **Ok**.

Note: See next page for details.

- ▶ Select **Addr:**.
- ▶ Select **Edit** to enter an address.
- ▶ Enter an address. Press **○** and select **Accept**.
- ▶ Select **Subj:**.
- ▶ Select **Edit** to enter a subject.
- ▶ Enter a subject, press **○** and select **Ok**.

To send your message, press **G** or press **○** and select **Send**.

To save your message press **○** and select **Save**. Your message is stored in the **Outbox**, so you can send it or edit it later.

You can send a camera image, text, a picture from a data folder and/or a sound from a data folder.

To send a camera image:

Messaging

- ▶ Select **Camera** as your item in Creating an MMS message.
- ▶ Take a picture.
- ▶ Press  to return to the MMS message.

To send a picture:

- ▶ Select **Picture** as your item in Creating an MMS message.
- ▶ Select a folder.
- ▶ Select the picture.



To enter text:

- ▶ Select **Text** as your item in Creating an MMS message.
- ▶ Enter the text.
- ▶ Select **Ok** or **Cancel**.

To attach an audio file:

- ▶ Select **Sound** as your item in Creating an MMS message.
- ▶ Select a folder.
- ▶ Select the audio file.

To review the message you created:

- ▶ Select **Play** as your item in Creating an MMS message.
- ▶ If a picture and text are inserted, they will be played.
If a sound is added, it will be displayed.
It is possible to adjust the volume by pressing  when playing the sound.
- ▶ Press  to select **Play Mode** or **Save Object**.
Play Mode. Decides whether to play a slide manually or automatically.
Save Object. Saves attached files in **Data Folders**.

To add a new slide:

- ▶ Select **Slide** as your item in Creating an MMS message.
- ▶ Select **Add** or **Insert** or **Delete**.

To set options:

- ▶ Select **Option** as your item in Creating an MMS message.
- ▶ Select a required option from the below.
Text Colour. Selects a colour of the text message.
Slide Time. Sets slide time when **Player Mode** is set to **Automatic**.
Background. Sets a background colour of the slide.

User messages

While entering text, you can enter one of the predefined user message in your MMS message:

- ▶ Select **Menu > User Msg**.
A list of the user defined messages is displayed.
- ▶ Select the message you require.

- ▶ Press .

To edit a user message, see Editing user messages on page 46.

Note: You can not enter user message when the text entry mode is numeric mode.

Inbox

The messages you receive are stored in the **Inbox**.

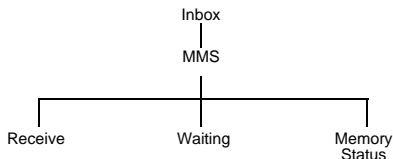

Select **Inbox > MMS**.



If there are messages waiting, a number appears by **Waiting**. You need to retrieve these messages before you can play any **Picture**, **Text** and **Sound** file attached to them.

Retrieving a message

- ▶ Select **Waiting**.
- ▶ Highlight a message.
- ▶ Press  to retrieve the message.

When you have retrieved a message it is available in **Receive**. The number of retrieved messages appears by **Receive**.

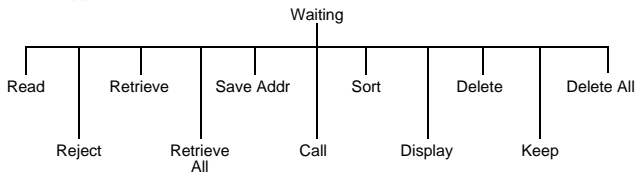

When you select a message from the **Waiting** menu, you can choose from:

Read. Displays the message header. Press  to retrieve the message.

Reject. Do not retrieve the selected message.

Retrieve. Retrieves the selected message.

Retrieve All. Retrieves all waiting messages.

Save Addr. Saves the address of the selected message.

Call. Call the person who sent the selected message.

Messaging

Sort. Sorts your messages.

Display. Selects how to display the list.

Delete. Deletes the selected message.

Keep. Keeps a message for you to retrieve later.

Delete All. Deletes all messages.

Reading received messages

Once you have retrieved a message, you can view it and play attached **Picture**, **Text** and **Sound** file.

- ▶ Select **Receive**.
- ▶ Highlight a message.
- ▶ Press  to play the message.

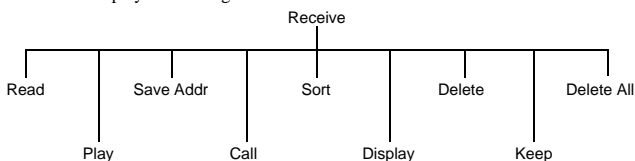

When you select a message from the **Receive** menu, you can choose from:

Read. Displays the message header.

Play. Plays the message.

Save Addr. Saves the address of the current message.

Call. Call the person who sent the message.

Sort. Sorts your messages.

Display. Selects how to display the list.

Delete. Deletes the selected message.

Keep. Keeps a message for you to read later.

Delete All. Deletes all messages.

Viewing your messages status in Inbox

To see a summary of waiting, received, sent, unused and vacant, select **Memory Status**.



Outbox

To access your **Outbox** select **Outbox > MMS**.

From your outbox you can view all your draft, pending and sent MMS messages. You can also see a summary of your memory status.

You can highlight a message, then press **ⓘ** to get the following menu options. The available options depend on whether you are looking at a draft, pending or sent message.

Read. Displays any text in the message.

Send. Sends the selected message.

Play. Plays the message.

Send All. Sends all the messages in the list.

Save Addr. Saves the address of the selected message.

Sort. Sorts your messages.

Display. Selects how to display the list.

Delete. Deletes the selected message.

Keep. Keeps a message for you to read later.

Delete All. Deletes all messages.

Edit. Edits the selected message.

SMS

SMS is usually called text messaging. With text messaging you can send and receive text. You can receive, display, edit and send text messages of up to 459 characters to mobile phones on your service provider's network or any network that has a roaming agreement. The actual number of characters available depends on the language you use. You can only send text messages to phones that have text messaging functionality.



Settings

The following functions are all available from **Settings > SMS**.

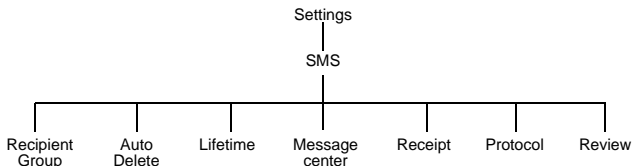

Messaging

Message center

You must enter the message center number before you can send text messages.

Note: The message center number may have been pre-programmed on the SIM.

- ▶ Select **Message center**.
- ▶ Enter the message center number in international dial format (see Making international calls on page 28).

Note: The message center number is provided by your service provider.

Recipient group

You can preset the destination of text messages. There are five recipient groups. You can store up to ten destinations in each group.

To name or rename a group:

- ▶ Highlight a group number or name.
- ▶ Press .
- ▶ Select **Rename**.
- ▶ Enter a new name.

To add names to a recipient group:

- ▶ Highlight a group number or name.
- ▶ Press .
- ▶ Select **Select**.
- ▶ Select **Entry**.
- ▶ Select required name.
- ▶ Select **Recall**.

To add another name:

- ▶ Press .
- ▶ Select required name.
- ▶ Select **Recall**.

When you have added all the names, press .

Note: You can only add numbers in Phone to recipient groups.

Auto delete

You can set this to automatically delete messages. You select from:

Off. Turns off **Auto Delete**.

Received Read. Overwrites the oldest read message.

Received Any. Overwrites the oldest read message or the oldest unread message if there are no read messages.

Lifetime

This is the time that your message is stored at the message center. The message center keeps trying to deliver the message until the message is delivered, or the **Lifetime** expires.

Receipt

You can choose whether you want to receive a confirmation when your message has been delivered. You select from **Yes**, **No** and **Ask**. If you select **Ask**, you are asked if you want to receive a delivery confirmation whenever you send a message.

Protocol

The **Message center** may be able to convert your message to the format specified by the selected protocol.

Review

You can see how many messages are stored in your SIM or in your phone. You can store up to 15 messages in your SIM (depending on your SIM) and 200 in your phone. If your SIM storage is full or nearly full, you can move messages to your phone storage. To move a message from SIM to mobile:



Note: SIM storage depends on your SIM. You can also move messages from your phone to your SIM.

- ▶ Select **Inbox** or **Outbox** > **SMS**.
- ▶ Highlight the message.
- ▶ Press .
- ▶ Select **Move**.
- ▶ Confirm that you want to move the message from the SIM to your phone, or your phone to the SIM.

Create



Use **Create** to create an SMS message.



- ▶ Select **Create** > **SMS**.
- ▶ Enter your text.
- ▶ Press .
- ▶ Select **Ok** or **Cancel**.
- ▶ Press  to send the message.
- ▶ Enter the phone number.

or

Messaging

- ▶ Press  > Select required number from Contact List > Select **Recall**.

or

- ▶ Select **Recipient** from Menu > Select required Recipient group > press .
- ▶ Press .
- ▶ Select **Ok** or **Cancel**.
- ▶ If you selected **Ask** as your Receipt option, then You are asked '**Request Delivery Confirmation?**' Press , then select **No** or **Yes**.

User messages

You can enter one of the predefined user message in your SMS message:

- ▶ Select **Menu** > **User Msg.**
A list of the user defined messages is displayed.
- ▶ Select the message you require.
- ▶ Press .

Note: You can not enter user messages when the text entry mode is numeric mode.

To edit a user message, see Editing user messages on page 46.

Inbox

 Indicates that you have received a new message. A flashing envelope indicates that your message store is full.



Received text messages are stored in your **Inbox**.

Select **Inbox** > **SMS** to see a list of your received messages.

Message options

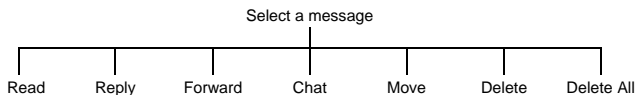

Read. Display any text in the message.

Reply. Reply to the person who sent the message.

Forward. Forward the message to someone else.

Chat. Read sent and received messages with another party on one screen.

- ▶ Select **Chat**.
- ▶ Enter a nickname. This can be up to 18 characters long.
- ▶ Send and receive messages.
- ▶ Press  to end the chat.

When you receive a message in chat mode, the text appears above your previous message.

If your phone is not in chat mode when you receive a reply to a chat message, it is received as normal SMS.

If you receive a voice call while you are in chat mode, you can accept the incoming call and return to chat mode at the end of the call.

To save a chat message session select **Menu > Save**

Move. Move the message to your phone or SIM memory.

Delete. Delete the message.

Delete All. Delete all messages.



Outbox

To access your Outbox select **Outbox > SMS**.

From your outbox you can view all your sent text messages.

You can select a message, and choose from the following options:

Edit. Edit the message.

Send. Send the message.

Read. Read the message.

Chat. Read sent and received messages with another party on one screen.

- ▶ Select **Chat**.
- ▶ Enter the phone number you want to chat with. (only when the number is not stored)
- ▶ Enter a nickname. This can be up to 18 characters long.
- ▶ Send and receive messages.
- ▶ Press  to end the chat.

When you receive a message in chat mode, the text appears above your previous message.

If your phone is not in chat mode when you receive a reply to a chat message, it is received as normal SMS.

If you receive a voice call while you are in chat mode, you can accept the incoming call and return to chat mode at the end of the call.

To save a chat message session select **Menu > Save**.

Create. Create another text message.

Move. Move the message to your phone or SIM memory.

Delete. Delete the message.

Delete All. Delete all messages.





Broadcasts

Broadcasts are messages sent on a variety of subjects by your service provider.

Topics

Before you can receive broadcasts, you need to specify the topics of information that you want to receive.

- ▶ Select **Topics**.
- ▶ Press .
- ▶ Select **Insert**.
- ▶ Use  to page through the list of available topics.
- ▶ Press  to select a topic.

If you want to specify more than one topic, keep paging through the topics and select all the ones that you want.

Turning broadcasts on and off

If you are busy, or do not want to receive broadcasts for a while, you can turn them off, and turn them on again later.

- ▶ Select **Receive**.
- ▶ Select **On** or **Off**.

Message list

The **Message List** stores the last broadcast messages that you received. You can delete messages from here.

Languages

You can change the language for your broadcast messages.

To edit language in the list:

- ▶ Select **Language**.
- ▶ Select **Menu > Edit**.
- ▶ Select the language from the list.

To add and insert language:

- ▶ Select **Language**.
- ▶ Select **Menu > Add** or **Insert**.
- ▶ Select the language from the list.



SMS chat

With **SMS Chat** you can read sent and received messages with another party on one screen.



Use this to start a call in chat mode.

- ▶ Enter the phone number you want to chat with.

To enter a number using the keypad:

- ▶ Enter the number, then select **Menu > Ok**.

To select a number from the contacts list:

- ▶ Press  to go to the **Contacts List**.
- ▶ Select the contact.
- ▶ Select **Recall**.
- ▶ Confirm the number, select **Menu > Ok**.
- ▶ Enter a nickname. This can be up to 18 characters long.
- ▶ Select **Menu > Ok**.
- ▶ Enter your message.
- ▶ Select **Menu > Send**.
- ▶ Press  to end the chat.

You can also enter a user message in your chat.

- ▶ Select **Menu > User Msg**.
A list of the user defined messages is displayed.
- ▶ Select the message you require.
- ▶ Press .

Note: You can not enter user messages when the text entry mode is numeric mode.

To edit a user message, see Editing user messages on page 46.

To save a chat message session select **Menu > Save**.

e-mail

You can send and receive e-mails via the mail server of an Internet Service Provider (ISP) that supports POP3/STMP protocols.

Before you can use the Internet e-mail feature your SIM must be data enabled, and you must have a contract with an ISP.



Settings

The following functions are all available from **Settings > e-mail**.

Messaging

Server list

You must configure your e-mail before you can send or receive e-mail messages.

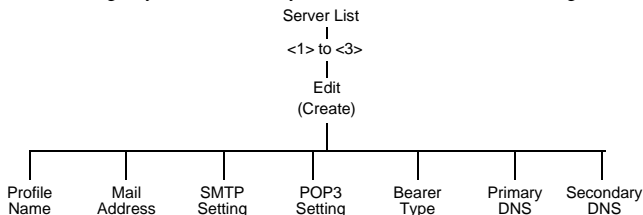

Use the following method to set the server options:

- ▶ Select the required option.
- ▶ Enter the option details or select the required setting.

Repeat these steps, until you have set all the required options.

Server profile option	Settings	Options	Options
Profile Name	Name for account, e.g. ISP name.		
Mail Address	Reply to address for sent e-mail.		
SMTP Setting	SMTP server		
	User ID		
	Password		
	Authentication		
			Off
POP3 Setting	POP3 server		
	User ID		
	Password		
	Mail delivery		
			Delete Msg.

Server profile option	Settings	Options	Options	
Bearer Type	Circuit switch	Digital Dial #		
		Analogue Dial #		
		Circuit Type		Digital
				Analogue
		User ID		
	User Password			
	GPRS	AccessPointName		
		User ID		
		User Password		
		Authentication		Normal
		Encrypted		
		None		
Primary DNS	Name Server at ISP (Normally set automatically unless ISP gives details)			
Secondary DNS	Name Server at ISP (Normally set automatically unless ISP gives details)			

Note: Once you have set up a server you need to select the new server and select **Set** to activate the new setting.

Options

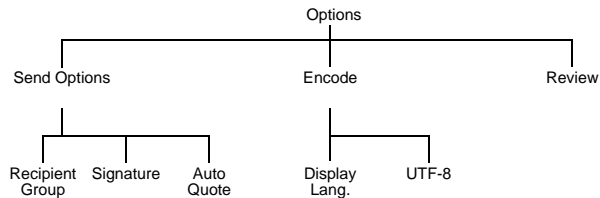

Recipient Group. Use to preset the destination of e-mail messages. There are five recipient groups. You can store up to ten destinations in each group.



Signature. Use this to insert essential information in outgoing messages, for example, disclaimer.

Auto Quote. Use this to attach text from the message that you are replying to. Set to **On** or **Off**.

Create



Use **Create** to create an e-mail message.

- ▶ Select **Create > e-mail**.
- ▶ Highlight **To, Cc** or **Bcc**.
- ▶ Press  twice to select an entry from your **Contacts List**.
Or
Press  and select **Edit**. Select **Menu > Add**, then enter the e-mail address.
- ▶ Repeat the previous steps until you have added all the recipients.
- ▶ Highlight **Subj** to enter a subject line.
- ▶ Select **Edit**.
- ▶ Enter text, then select **Menu > Ok**.
- ▶ Highlight **Message** to enter your message.
- ▶ Select **Edit**.
- ▶ Enter text, then select **Menu > Ok**.
- ▶ To attach a file, highlight **File**.
- ▶ Select **Edit**.
- ▶ Select **Menu > Add**.
- ▶ Select the required folder.
- ▶ Select the required file, then select **Menu > Ok**.

You can also enter a user message in your e-mail by:

- ▶ Select **Menu > User Msg**.
A list of the user defined messages is displayed.
- ▶ Select the message you require.
- ▶ Press .

Note: You can not enter user messages when the text entry mode is numeric mode.

To edit a user message, see Editing user messages on page 46.

Send/Receive

You can send and receive e-mails at the same time. This sends any unsent messages in your **Outbox**, and downloads any messages that are in your server mailbox to your phone's **Inbox**.



You access this function from **e-mail**.

- ▶ Select **e-mail**.

When messages are in **Draft** or **Pending**:

- ▶ “**Send All Messages?**” is displayed.
- ▶ When pressing , or on completion of sending a message, “**Receive All Messages?**” is displayed.

When no messages are in **Draft** or **Pending**:

- ▶ “**Receive All Messages?**” is displayed.

Note: If no messages are sent or received and the connection is left idle, it terminates after 60 seconds.

Inbox

Your received e-mail messages are stored in your **Inbox**.



- ▶ Select **Inbox > e-mail**.
- ▶ Select a message.
- ▶ Select **Read**.

Message status

The following icons indicate the status of a message:



Read or sent message.



Unread message.



Message is locked.



Message has attached files.

Messaging

Received messages options

With the message displayed, press .

Select from:

Reply. Send a reply to the sender.

Reply to All. Send a reply to all the people who were sent the message.

Forward. Send the message to another person.

Make. Create a new message to send to the sender or save the sender's address in your contacts list.

Sort. Sort all the messages in your inbox.

Read. Read the message.

Display. Change the e-mail display to **Subject** or **Address**.

Protect/Unprotect. Use **Protect** to stop the message being overwritten when your **Inbox** is full. If a message is protected and you no longer want it to be protected, select **Unprotect**.

Delete. Deletes the message.

Delete All. Delete all the messages in your **Inbox**.

Properties. View details of the message, for example, file size (KB).



Outbox

To access your **Outbox** select **Outbox > e-mail**.

From your outbox you can view all your draft, pending and sent e-mail messages. You can highlight a message, then press  to get the following menu options. The available options depend on whether you are looking at a draft, pending or sent e-mail message.

Read. Read the message.

Edit. Edit the message.

Send All. Sends all the messages in the list.

Make. Create a new message.

Sort. Sorts your message.

Display. Selects how to display the list (Subject or Address).

Delete. Deletes the selected message.

Delete All. Deletes all messages.

Property. View details of the message, for example, file size (KB).



Voice mailbox

Before you can use voice mail, you may need to contact your service provider.

- ▶ Select **Voice Mailbox**.

To Recall

- ▶ Select **Recall** from menu.
- ▶ Press  to dial the number.

Follow the instructions given by your service provider at this number.



Data folders

You can access your **Data Folders** directly from the top level menu. For details on the Data Folder options, see Data folders on page 100.

Managing your inbox and outbox

When your **Inbox** or **Outbox** is full, any new messages that you create or receive will overwrite existing messages, starting with the oldest. To prevent messages being overwritten you should regularly clean up your lists, deleting any messages that you no longer require.



Data folders

Use data folders to store your pictures, sounds and themes. There are three predefined folders for **My Pictures**, **My Sounds** and **My Themes**. These may contain preloaded files. There are five empty folders. You can customise any of these folders. The maximum capacity of **Data Folders** is 4Mb, and it can hold up to 900 files. The maximum file size is 100KB.

Note: You cannot change or forward wallpaper and ring type files that you have downloaded from the Internet.

Changing the SIM does not affect the contents of the data folders.

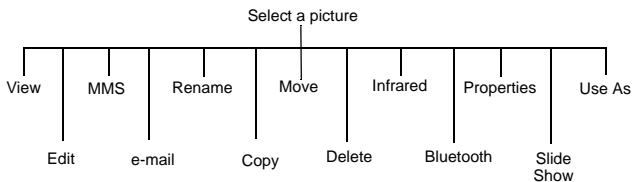

The phone can only display files that are in one of the supported formats. see Specifications on page 144 for the supported formats.

My Pictures





Note: The available functions depend on the type of the photo.

Viewing stored pictures

- ▶ Select the folder where your pictures are stored.
- ▶ Select the picture that you want to view.
- ▶ Press , or press  and select **View**.

Editing stored pictures



From the **Edit** menu you can change the **Brightness**, **Effect**, **Frame**, **Size**, **Format** and **Trim** of a stored picture. When you have edited the picture, press  to save your changes.

- ▶ Select the folder where your pictures are stored.
- ▶ Select the picture that you want to edit.
- ▶ Select **Edit**.
- ▶ Press .

Note: You cannot use this for predefined wallpaper files.

For information about these options, see Editing the picture on page 75.



Sending a picture by MMS

- ▶ Select the folder where your pictures are stored.
- ▶ Select the picture that you want to send.
- ▶ Press  and select **MMS**.
- ▶ Select an address from the Address List or press  to select an address from your Contacts List.

A new MMS message is opened with the picture already embedded.



Note: You cannot use this for predefined wallpaper files.

Sending a picture by e-mail

- ▶ Select the folder where your pictures are stored.
- ▶ Select the picture that you want to send.
- ▶ Press  and select **e-mail**.
- ▶ Highlight **To**, **Cc**, or **Bcc**.
- ▶ Press  , twice to select an entry from your Contact List.

Note: You must set e-mail server setting to send a picture by e-mail.
You cannot use this for predefined wallpaper files.

Renaming a picture

- ▶ Select the folder where your pictures are stored.
- ▶ Select the picture that you want to rename.
- ▶ Press .
- ▶ Select **Rename**.
- ▶ Remove the existing text using  , then enter the new name.

Note: You cannot use this for predefined wallpaper files.

Copying or moving a picture

- ▶ Select the folder where your pictures are stored.
- ▶ Select the picture that you want to copy or move.
- ▶ Press .
- ▶ Select **Copy** or **Move**.
- ▶ Select the folder to move or copy to.

Note: The default folder is the last one that you copied or moved to.
You cannot use this for predefined wallpaper files.

Deleting a picture

- ▶ Select the folder where your pictures are stored.
- ▶ Select the picture that you want to delete.
- ▶ Press .
- ▶ Select **Delete**.
- ▶ Confirm delete.

Note: You cannot use this for predefined wallpaper files.

Sending a picture via infrared

Set up the devices so that the infrared ports are pointing at each other, and within the effective range of infrared connection.

Ensure that there are no obstructions between the devices.

- ▶ Select the folder where your pictures are stored.
- ▶ Select the picture that you want to send.
- ▶ Press .
- ▶ Select **Infrared**.

If you fail to send a picture via infrared, “Send To Infrared Failed” message appears.

- ▶ Select **Retry** to try again.

or

- ▶ Press  to cancel.

Note: You cannot use this for predefined wallpaper files.

Sending a picture via Bluetooth®

- ▶ Select the folder where your pictures are stored.
- ▶ Select the picture that you want to send.
- ▶ Press .
- ▶ Select **Bluetooth**.
- ▶ Select the Bluetooth® device from the list of Paired Devices or select **Find** to Discover another Bluetooth® device.

If you fail to send a picture via Bluetooth®, “Send To Bluetooth Failed” message appears.

- ▶ Select **Retry** to try again.

or

- ▶ Press  to cancel.

Note: You cannot use this for predefined wallpaper files.

Viewing the image properties

You can see the image name, the date and time that it was created, its size, whether or not it is copyrighted and whether or not you can forward and copy the file.

- ▶ Select the folder where your pictures are stored.
- ▶ Select the picture that you want.
- ▶ Press .
- ▶ Select **Properties**.

Using images as a slide show

You can display the images in the folder as a slide show, starting with the current image. Each image displays for five seconds. You can select **Pause** to stop the slide show, and **Cont** to continue with the slide show.

- ▶ Select the folder where your pictures are stored.
- ▶ Select the picture.
- ▶ Press .
- ▶ Select **Slide Show**.

Using the picture as your wallpaper

- ▶ Select the folder where your pictures are stored.
- ▶ Select the picture that you want.
- ▶ Press .
- ▶ Select **Use As**.
- ▶ Select **Wallpaper**.

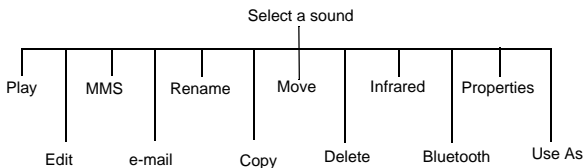

Your wallpaper is updated to use the selected picture.

My Sounds



Note: The functions available depend on the type of sound file.

Playing stored sounds

- ▶ Select the folder where your sounds are stored.
- ▶ Select the sound that you want to play.
- ▶ Press , or press  and select **Play**.



Editing stored sounds

- ▶ Select the folder where your sounds are stored.
- ▶ Select the sound that you want to edit.
- ▶ Select **Edit**.

See Creating a ring type on page 42, for information on how to edit a sound.

Note: You cannot use this for polyphonic ring types or music files.

Sending a sound by MMS



- ▶ Select the folder where your sounds are stored.
- ▶ Select the sound that you want to send.
- ▶ Press  and select **MMS**.
- ▶ Selects an address from the Address List or press  to select an address from your Contacts List.

A new MMS message is opened with the sound already embedded.

Note: You cannot use this for polyphonic ring types or music files.



Sending a sound by e-mail

- ▶ Select the folder where your sounds are stored.
- ▶ Select the sound that you want to send.

- ▶ Press  and select **e-mail**.
- ▶ Highlight **To**, **Cc**, or **Bcc**.
- ▶ Press , twice to select an entry from your Contact List.

Note: You must set e-mail server setting List to send a picture by e-mail.
You cannot use this for polyphonic ring types or music files.

Renaming a sound

- ▶ Select the folder where your sounds are stored.
- ▶ Select the sound that you want to rename.
- ▶ Press .
- ▶ Select **Rename**.
- ▶ Remove the existing text using , then enter the new name.

Note: You cannot use this for polyphonic ring types or music files.

Copying or moving a sound

- ▶ Select the folder where your sounds are stored.
- ▶ Select the sound that you want to copy or move.
- ▶ Press .
- ▶ Select **Copy** or **Move**.
- ▶ Select the folder to move or copy to.

Note: The default folder is the last one that you copied or moved to.
You cannot use this for polyphonic ring types or music files.

Deleting a sound

- ▶ Select the folder where your sounds are stored.
- ▶ Select the sound that you want to delete.
- ▶ Press .
- ▶ Select **Delete**.
- ▶ Confirm delete.

Note: You cannot use this for polyphonic ring types or music files.

Sending a sound via infrared

Set up the devices so that the infrared ports are pointing at each other, and within the effective range of infrared connection.

Ensure that there are no obstructions between the devices.

Data folders

- ▶ Select the folder where your sounds are stored.
- ▶ Select the sound that you want to send.
- ▶ Press .
- ▶ Select **Infrared**.

If you fail to send a sound via infrared, “Send To Infrared Failed” message appears.

- ▶ Select **Retry** to try again.

or

- ▶ Press  to cancel.

Note: You cannot use this for polyphonic ring types or music files.

Sending a sound via Bluetooth®

- ▶ Select the folder where your sounds are stored.
- ▶ Select the sound that you want to send.
- ▶ Press .
- ▶ Select **Bluetooth**.
- ▶ Select the Bluetooth® device from the list of Paired Devices or select **Find** to Discover another Bluetooth® device.

If you fail to send a sound via Bluetooth®, “Send To Bluetooth Failed” message appears.

- ▶ Select **Retry** to try again.

or

- ▶ Press  to cancel.

Note: You cannot use this for polyphonic ring types or music files.

Viewing the sound properties

You can see the file name, the date and time that it was created, its size, whether or not it is copyrighted and whether or not you can forward and copy the sound.

- ▶ Select the folder where your sounds are stored.
- ▶ Select the sound that you want.
- ▶ Press .
- ▶ Select **Properties**.

Using the sound as your ring type

- ▶ Select the folder where your sounds are stored.
- ▶ Select the sound that you want.
- ▶ Press .
- ▶ Select **Use As**.
- ▶ Select the type of call you want to use the ring type.
- ▶ Your ring type is updated to use the selected sound.

My Themes

The phone has seven predefined themes. A theme contains a colour scheme. It may also contain a wallpaper and/or a ringtone. You use a theme to change the look and feel of your phone.

Note: The seven predefined themes only contain a colour scheme. They set the colours used on your screen. They do not contain a wallpaper or a ringtone.

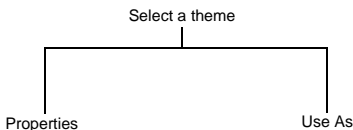

Viewing the theme properties

You can see the theme name, the date and time that it was created, its size, whether or not it is copyrighted and whether or not you can forward and copy the theme.

- ▶ Select the folder where your themes are stored.
- ▶ Select the theme that you want.
- ▶ Press .
- ▶ Select **Properties**.

Using the theme

This changes the colours used on your screen to those in the selected theme. If the theme contains a wallpaper, it also updates the wallpaper on your phone to that in the selected theme. If the theme contains a ringtone, this is saved to your My Sounds folder. The ringtone on your phone is not updated automatically.

- ▶ Select the folder where your themes are stored.
- ▶ Select the theme that you want.
- ▶ Press .
- ▶ Select **Use As > Theme**.

Manipulating folders

From the list of folders available, highlight a folder, and press .

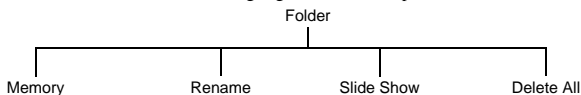

Memory

Select **Memory** to display the percentage of memory used and the number of files currently in the folder.

Rename (User folders 1-5 only)

Select **Rename** to rename the folder.

Note: You can not rename My Pictures, My Sounds, My Theme.

Slide show

Select **Slide Show** to display all the images stored in the folder in the order listed as a slide show. Each image displays for five seconds. You can select **Pause** to stop the slide show, and **Cont** to continue with the slide show.

Note: You can only do this for folders that contain graphics files.

Delete all

Select **Delete All** to delete all the downloaded contents of the folder. If the folder does not contain any downloaded files, nothing is deleted.

Downloading wallpapers, ringtones and themes

You can download images to use as wallpaper, melodies to use as ringtones and themes to change the look of your phone.

The Panasonic website is <http://www.panasonicbox.com>.

Note: The Panasonic Box service is country and network operator dependent.

For a list of supported countries and operators:

- ▶ Go to <http://www.panasonicbox.com>.
- ▶ Select your region.
- ▶ Click on FAQ.
- ▶ Click on General.
- ▶ View the list of currently supported countries and network operators.

Before you can download any files you need to register with Panasonic Box.

- ▶ Go to <http://www.panasonicbox.com>.
- ▶ Select your region.
- ▶ Click on User Registration.
- ▶ Follow the instructions on the screen.



To access the site from your phone, you need to save the URL as a bookmark.

- ▶ Select **Browser**.
- ▶ Select **Enter URL**.
- ▶ Enter <http://wap.panasonicbox.com>.
- ▶ Select **Ok**. The Panasonic WAP home page is displayed.



Downloading a colour logo

- ▶ Log in to Panasonic Box.
- ▶ Select Logos and press .
- ▶ Select the category of the logo that you want to download and press .
- ▶ Select the number of the colour logo you wish to download and press .
- ▶ Check whether this is the logo you want to download, select Download and press .
- ▶ Press  to select **Menu**.
- ▶ Select **Save Image**.
- ▶ Select the folder where you want to save the image.





Downloading a ringtone

- ▶ Log in to Panasonic Box.
- ▶ Select Ringtones and press .
- ▶ Select the category of the ringtone that you want to download and press .
- ▶ Select the number of the ringtone you want to download and press .

Data folders

- ▶ Select Download and press .
- ▶ Press  to save the ringtone.
- ▶ Select the folder where you want to save the sound.

Downloading a theme

- ▶ Log in to Panasonic Box.
- ▶ Select Theme and press .
- ▶ Select the category of the theme that you want to download and press .
- ▶ Select the number of the theme you want to download and press .
- ▶ Select Download and press .
- ▶ Press  to save the theme.
- ▶ Select the folder where you want to save the theme.

Setting up a downloaded theme

To set up the colours and wallpaper associated with your theme see Using the theme on page 107.

To set up the ringtone associated with your theme, see Using the sound as your ring type on page 106.

Note: Not all downloadable themes on Panasonic Box have ringtones. Some contain only a colour scheme and a wallpaper.



Organiser

The menus are as follows:



Synchronization

- 1 Sync Schedule
- 2 Sync Contacts
- 3 Server List
- 4 Restore Schedule
- 5 Restore Contacts



Contacts List

- 1 Browse
- 2 Create
- 3 Voice Dial
- 4 Groups
- 5 Settings
- 6 SIM
- 7 Storage



Converter



Business Card

- 1 View
- 2 Bluetooth
- 3 Infrared



Schedule



Calculator



Alarm



Memo

- 1 Record
- 2 Playback
- 3 Delete



Receive object

This option is
SIM dependent.



Connect

This option is
SIM dependent.



Synchronization

Use this to synchronize your **Contacts List** and **Schedule** with data on an external server. You may need to do this if you store this type of information on several devices, and you want them all to be the same.

Setting your servers

Note: Your server settings may have been pre-configured by your service provider. If you change them, you may not be able to synchronize with the server.

Before you can synchronize your data, you need to set up your servers. These are the servers that control your Internet connection.

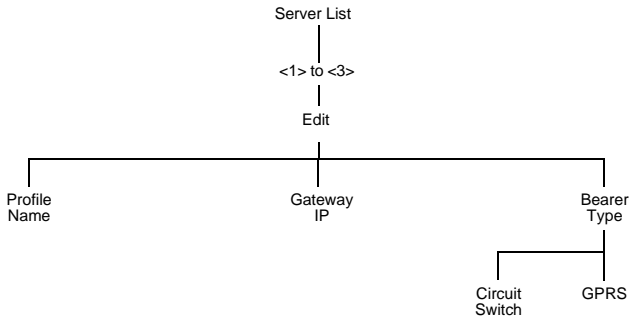

For **Circuit Switch**, select **Set**, then select **Edit** and set:

- Digital Dial #
- Analogue Dial #
- Circuit Type. Select from **Digital** and **Analogue**.
- User ID
- User Password

For **GPRS**, select **Set**, then select **Edit** and set:

- Access Point Name
- User ID
- User Password
- Authentication. Select from **Normal**, **Encrypted** and **None**.

Note: Once you have set up a server you need to select the new server and select **Set** to activate the new setting.

Synchronizing your contacts list

Before you can synchronize your contacts list, you have to set up a connection to the external database. You can set up two connections.

- ▶ Highlight **Sync Contacts**.
- ▶ Select **Edit**.
- ▶ Select a connection.
- ▶ Select **Edit**.
- ▶ Enter the information about the connection.

You need to set:

- Profile Name. This can be whatever you want to call the connection.
- Server Name. Enter the server URL.
- Server Database. Enter the name of the database.
- Server User ID. Enter your user ID.
- Server Password. Enter your user password

You can just send changes to the external database, or send all your records to the external database.

To just send changes to the external database:

- ▶ Select **Sync Contacts**.

Note: If it is the first time to select **Sync Contacts** “Synchronize All Data?” is displayed and select **Ok**.

To send all your records to the external database:

- ▶ Select **Restore Contacts**.

Synchronizing your schedule

Before you can synchronize your schedule, you have to set up a connection to the external database. You can set up two connections.

- ▶ Highlight **Sync Schedule**.
- ▶ Select **Edit**.
- ▶ Select a connection.
- ▶ Select **Edit**.
- ▶ Enter the information about the connection.

You need to set:

- Profile Name. This can be whatever you want to call the connection.
- Server Name. Enter the server URL.
- Server Database. Enter the name of the database.
- Server User ID. Enter your user ID.
- Server Password. Enter your user password

You can just send changes to the external database, or send all your records to the external database.

To just send changes to the external database:

- ▶ Select **Sync Schedule**.

Note: If it is the first time to select **Sync Schedule** “Synchronize All Data?” is displayed and select **Ok**.

To send all your records to the external database:

- ▶ Select **Restore Schedule**.



Contacts list

This accesses the same options as the Contacts List menu on the main menu. See Contacts list on page 57 for information on these options.



Converter

Use the converter to convert from/to a home currency using a conversion rate that you enter.

Entering an initial conversion rate

- ▶ Select **Converter** > **Edit**.
- ▶ Enter your abbreviation for the home currency (maximum three characters).
- ▶ Enter your abbreviation for the foreign currency (maximum three characters).
- ▶ Enter the current currency conversion rate.

Once you have entered a conversion rate it is retained in the phone. You can edit the conversion rate and currency abbreviation.

Converting a value

- ▶ Confirm that the conversion rate is correct, if not select **Edit** to edit it.
- ▶ Press **OK**.
- ▶ Enter the amount to convert.
- ▶ Press **OK**.

Reversing the currency conversion

When you have accepted the conversion rate and are ready to enter the value to convert, you can swap the currencies to convert from the foreign currency into the home currency.

- ▶ Select **Swap**.
- ▶ Enter the value to convert.
- ▶ Press **OK**.



Business card

With **Business Card** you can enter some details about you, and send them to a Bluetooth® or infrared device.















Entering details

- ▶ Select **View**.
- ▶ Select the item you want to enter or change.
- ▶ Select **Edit**.
- ▶ Enter the text.

► Press  to save the card.

Note: To save the Business card, you need to enter name, phone number, or e-mail address at least.

You can enter the following information:

Item		Number of characters
	First name	16
	Last name	16
	Home number	40
	Work number	40
	Mobile number	40
	Other number	40
	Home e-mail	80
	Work e-mail	80
	Other e-mail	80
	URL	80
	Title	16
	Company name	16
	Note	32
	Photo	Select a picture from the list or take a picture with the camera.

Send your details to a Bluetooth® device

Select **Bluetooth**.

The phone searches for another Bluetooth® device. Select **Stop** when the Bluetooth® device is displayed.

Select the Bluetooth® device from the list or select **Find** to Discover another Bluetooth® device.

Send your details to an infrared device

Set up the devices so that the infrared ports are pointing at each other, and within the effective range of infrared connection.

Ensure that there are no obstructions between the devices.

Select **Infrared**.

Note: To receive a business card from another infrared or Bluetooth® device use Receive Object. See Receive object on page 124.





Schedule

Use the schedule to register reminders for events and for planning holiday periods.

Caution: You need to ensure that any settings made in the schedule will not automatically power on the phone when you are in an aircraft, medical facility etc. See Safety first on page 5.

Creating a reminder

- ▶ Select **Menu > Create**.
- ▶ Press .
- ▶ Enter the start date.
- ▶ Enter the end date.
- ▶ Select the next menu item.
- ▶ Enter the start time.
- ▶ Enter the end time.
- ▶ Select the next menu item. Select from **Once, Daily, Weekly** and **Yearly**.
- ▶ Select the next menu item. Enter any notes that you want to make.
- ▶ Select the next menu item. Select a ring type.
- ▶ Press  to save the entry.

Viewing a reminder

- ▶ Highlight a date.
- ▶ Select **View** or select **Menu > View**.
- ▶ Select the reminder.
- ▶ Select **Detail**.

Deleting a reminder

- ▶ Highlight a date.
- ▶ Select **Menu > Delete**.
- ▶ Select from **Day, Past** and **All**.

Day, deletes all the reminders on the selected day.

Past, deletes all reminders prior to the selected day.

All, deletes all reminders.

Setting a holiday reminder

To set Day:

- ▶ Select **Menu > Options**.
- ▶ Select **Holiday Set**.
- ▶ Select **Day**.
- ▶ Press and hold  to remove the current date.
- ▶ Enter the new date.
- ▶ Select **Menu > Ok**.
- ▶ Repeat for each day of holiday as required.

To set Day of the week:

- ▶ Select **Menu > Options**.
- ▶ Select **Holiday Set**.
- ▶ Select **Day of the week**.
- ▶ Select required Day of the week.
- ▶ Repeat for each Day of the week of holiday as required.

Note: Dates that you set as holiday dates are shown in red.

Deleting holiday reminders

- ▶ Select **Menu > Options**.
- ▶ Select **Holiday Set**.
- ▶ Select **Holiday List**.
- ▶ Select required holiday date.
- ▶ Select **Delete**.
- ▶ Confirm delete.

To delete all your holiday reminders:

- ▶ Select **Menu > Options**.
- ▶ Select **Holiday Set**.
- ▶ Select **All Clear**.
- ▶ Confirm delete.

Review a holiday reminder

- ▶ Select **Menu > Options**.
- ▶ Select **Holiday Set**.
- ▶ Select **Review**.

Review schedule

- ▶ Select **Menu** > **Options**.
- ▶ Select **Review**.

Changing the schedule layout

You can decide which day you want to have at the start of the week.

- ▶ Select **Menu** > **Options** > **Start of week**.
- ▶ Select the day.

Jumping to a date



Rather than scrolling through each month on the schedule, you may want to go straight to a specific date to see whether you have any reminders set.

- ▶ Select **Menu** > **Jump**.
- ▶ Press and hold  to remove the current date.
- ▶ Enter the date you want to go to.
- ▶ Select **Ok**.



Calculator

The four function calculator performs simple calculations - addition, subtraction, multiplication and division.

- ▶ Select **Calculator**.
- ▶ Enter a number (maximum 10 digits).
- ▶ Use  to select the arithmetic operator.
- ▶ Enter another number (maximum 10 digits).
- ▶ If the calculation is complete press  to get the result.
- ▶ If the calculation is not complete, enter numbers and arithmetic operators, until the calculation is complete, then press  to get the result.

If you press  :

- before calculation, you will exit **Calculator**.
- during calculation, a number you have just entered will be deleted.
- while the result is displayed, it will be deleted.

If you press and hold  , the line of numbers entered will be deleted.

Note: To enter a decimal point press  .



Alarm

Sets the time, frequency and tone for an alarm call. You can set up to four alarms.

Setting an alarm





- ▶ Select **--:--** to enter a new alarm, or select an existing alarm time to set alarm.
- ▶ Select **--:--** to enter a new alarm, or select an existing alarm time to edit.
- ▶ Enter the time.
- ▶ Select the next menu item to set the frequency of the alarm.
- ▶ Choose from **Repeat Daily**, **Once** or **Disabled**.
- ▶ Select the next menu item to set an alarm tone.
- ▶ Choose the sound you required.
- ▶ Press  to save your alarm settings.

Once you have set an alarm you can highlight it and use  to cycle through **Repeat Daily**, **Once** or **Disabled**. The icon next to the alarm time changes to show which option you have selected.

Disabling an alarm

- ▶ Select an existing alarm time.
- ▶ Select the frequency option.
- ▶ Select **Disabled**.
- ▶ Press  to save your alarm settings.

Or

- ▶ Highlight an existing alarm time.
- ▶ Press  to cycle through **Repeat Daily** () , **Once** () or **Disabled** () .
- ▶ Stop at **Disabled**.



Memo

Use the Memo to record a two-way conversation during a call, and to use the phone as a voice memo. You can record up to four memos. The maximum length of each memo is 14 seconds



Note: You can press the memo key on the side of the phone to access the memo function from idle mode.

If you install a different SIM you will lose your current memos.



When you have filled the four memo storage areas, any new recording overwrites the oldest memo.

Caution: You are responsible for the security of a recorded message. You should ask for the other party's consent before recording.

Recording a memo

- ▶ Select **Record**.
- ▶ Record your message.
- ▶ Press  to stop recording.
- ▶ Press  to start recording the next memo.

Recording a conversation

- ▶ To start recording during a call press  and select **Memo** or press the memo key on the side of the phone. A tone sounds when recording starts and again when it stops.
- ▶ To stop recording, press .

Note: While recording, use **e** to adjust the volume.

Playing back a recording

- ▶ Select **Playback**.
- ▶ Select a recording.

To stop playing press  twice.

Note: You can use the notepad during play back, see Using the notepad on page 34.

Volume control during play back

While playing back a recording, use  to adjust the volume.

H'free or H'held during play back

While playing back a voice memo, you can choose H'free or H'held from Menu.

Deleting a recording

- ▶ Select **Delete**.
- ▶ Select the recording.
- ▶ Confirm delete recording.



Connect

From the **Connect** menu you can set up your Bluetooth® and infrared dialup connections and receive data from other devices.

Note: You can access the **Connect** menu from the top level menu or via the **Organiser** menu. This is SIM dependent.

Bluetooth®

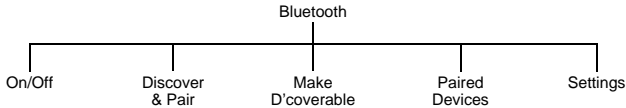

Bluetooth® provides wireless connections from your X70 to headsets, car kits, PC's, laptops and other devices. It uses a radio link which provides fast and reliable transmission of data and voice without the need for a line of sight connection. It operates over a distance of about 33 feet, although you may be able to achieve a distance of up to 100 feet.

You can use Bluetooth® on X70 to:

- Make and receive voice calls using a Bluetooth® headset or car kit.
- Transfer pictures, sounds, themes or other data files to or from PC's, laptops or other mobile phones that support Bluetooth®.
- Send and receive electronic business cards with other mobile phones that support Bluetooth®.
- Connect a computer to the Internet so you can send e-mails or browse websites.
- Connect to a computer to send and receive faxes.

Turning Bluetooth® on and off

When Bluetooth® is on, the Bluetooth® icon (📶) is displayed at the top of the main display. If you leave Bluetooth® on you can make and answer calls using your Bluetooth® headset or car kit, send e-mails and browse websites without pressing any keys on your X70.

Note: Leaving Bluetooth® on reduces the phone's standby time by about 20%.

- ▶ Select **On/Off**.
- ▶ Select **On** or **Off**.

If Bluetooth® is active and you choose to turn it off, you are prompted to confirm the disconnection.

Note: You can send and receive pictures, sounds, themes, contact details and other data when Bluetooth® is off. Your X70 automatically switches Bluetooth® on while the transfer is taking place, then switches it off when the transfer is complete.

Discovering and pairing devices

To use your Bluetooth® headset or car kit with X70 to make voice calls or to use your Bluetooth® enabled laptop to connect to the Internet you must Pair them with your X70. You only need to do this once for each device, thereafter X70 remembers these devices and stores them in its Paired Devices list. Your phone can be Paired with up to ten devices.

▶ Select **Discover & Pair**.

This lists all Discoverable Bluetooth® devices within about 33 feet.

▶ When the device appears in the list you can select **Stop** to stop the search.

▶ If the phone does not discover your device, you can press  to try again.

▶ Highlight the device in the list.

▶ Select **Pair**.

▶ Enter the Bluetooth® Passkey provided with the device.

If the device you want to pair with is not listed then check that it is Discoverable. Some Bluetooth® devices are not Discoverable even if they are within 33 feet range. Most Bluetooth® headsets and car kits must be put into Discoverable mode. This is a security feature to prevent other Bluetooth® devices from Pairing with your headset or car kit. The pairing will fail if you enter the wrong Passkey. Most Bluetooth® headsets and car kits use a fixed 4 digit Passkey, e.g. the Passkey for the Panasonic EB-BHX70 headset is 0000. For other devices such as a PC, laptop or another mobile phone that don't use a fixed Passkey enter the same Passkey on both devices. This can be anything from 1 to 16 digits long.

Note: Some manufactures may use the term PIN, Password or Passcode instead of Passkey. X70 only supports Passkeys that use numbers not letters.

Making the phone discoverable

You can also Pair with another Bluetooth® device by making your phone discoverable and letting the other Bluetooth® device initiate the Pairing. To make your phone discoverable:

- ▶ Select **Make D'coverable**.
- ▶ Select **Start**.

Your phone will be discoverable for five minutes. While the phone is discoverable, the Bluetooth® icon flashes. If you pair your devices in less than five minutes you can turn off discoverable mode:

- ▶ Select **Make D'coverable**.
- ▶ Select **Stop**.

If you take longer than five minutes to pair your devices, your phone automatically turns off discoverable mode and you have to start it again.

Viewing, editing and deleting your paired devices

To see what devices you currently have paired select **Paired Devices**, and look at the list on the screen.

If you have no paired devices, you can select **Find** to discover a device.

You can select an item on the list and choose to edit it or delete it. If you choose **Edit**, you can rename the device.

Note: Your X70 can be Paired with up to ten devices.

Selecting default audio device

If your X70 is Paired with more than one audio device (headsets, car kits, etc.) then the last device that you Paired is your default audio device. When you transfer audio to Bluetooth® during a call you transfer to the default audio device. When you receive a call, only the default audio device ring.

If you want to change the default audio device:

- ▶ Select **Paired Devices**.
- ▶ Highlight the device that you want to be the default.
- ▶ Select **Menu > Make Default**.

Note: If the **Make Default** option is not available, then this device is already the default device.

Viewing your Bluetooth® settings

Your Bluetooth® name is the name reported to other Bluetooth® devices when they Pair or exchange data with your phone. By default the name is Panasonic X70 but we recommend that you change it.

To view your Bluetooth® name and address select **Settings**.

Connect

To edit the name select **Menu > Edit**.

You cannot change your Bluetooth® address.

Sending objects via Bluetooth®

You can send data from **Contacts List, Data Folders, Business Card**.

For **Contacts List**, select **> Contacts List > Browse > Bluetooth**.

For **Data Folders**, highlight the object you want to send. Press **⊙**. Select **Bluetooth**.

For **Business Card**, select **Organiser > Business Card > Bluetooth**.

Receiving objects via Bluetooth®

From the **Connect** menu select **Receive Object**.

The phone waits for incoming data from either Bluetooth® or infrared port. If data is received from a Bluetooth® device you are asked if you want to accept the data. You do not need to Pair with the other Bluetooth® device.

Note: If Bluetooth® is off when you send or receive objects, X70 automatically switches Bluetooth® on while the transfer is taking place, then switches it off when the transfer is complete.

When you receive **Calendar** or **Contacts List** data, these applications are launched, and you are prompted to save the received data.

When you receive multimedia data, the **Data Folders** are opened, and you can choose where to save the file.

Connecting your computer to the Internet via Bluetooth®

You can use Bluetooth® to connect your computer (laptop, notepad or PC) to your phone without using any cables. Your phone acts as a modem. You can use it to connect your computer to the Internet for web browsing, sending and receiving e-mails and transferring files (FTP).

Your Internet connection can be circuit switched (CSD) which gives a connection speed of up to 9.6 kbps or GPRS which gives a connection speed of up to 57.6 kbps. With GPRS you are usually only charged for the amount of data sent and received, not for the duration of the connection. Also, with GPRS, you can still make and receive voice calls while accessing the Internet, although the GPRS connection is suspended during the voice call.

Note: To use CSD you must subscribe to your network operator's CSD service. To use GPRS you must subscribe to your network operator's GPRS service.

To set up your computer and phone you need to:

- Subscribe to CSD or GPRS service.
- Install Bluetooth® on your computer.

- Pair your computer with your phone.
- Install the Data Connection Assistant software on your computer.
- Set up a dial up connection on your computer to access the Internet via your phone.

Note: Installation instructions for your computer may vary depending on your computer's operating system, web browser, Bluetooth® Adaptor, etc. For further information please refer to the documentation on the CD-ROM, or to the Panasonic website www.panasonicmobile.com/support/software.

Installing Bluetooth® on your computer

If your computer does not have Bluetooth® built in, you need to:

- Get a Bluetooth® USB or PCMCIA adaptor.
- Plug the Bluetooth® adaptor into your computer.
- Install the software provided with the adaptor.

Pairing your computer with your phone

You need to Pair your phone with your computer. You can do this from the phone in the same way as you Pair with a Bluetooth® headset (see Discovering and pairing devices on page 122) or you can do it from the computer:

First you need to turn on Bluetooth® on the phone:

- ▶ Select **Menu > Connect > Bluetooth > On/Off > On**.

The Bluetooth® icon appears on the phone.

Then make the phone Discoverable:

- ▶ Select **Menu > Connect > Bluetooth > Make D'coverable > Start/Stop > Start**.

On your computer, run your Bluetooth® application.

Select Find Bluetooth® Devices.

Your computer should Discover your phone.

- ▶ On your computer select Pair, then enter the Passkey (any number from 1 to 16 digits).
- ▶ On your phone enter the same Passkey then select Ok.

Installing the Data Connection Assistant software

The Data Connection Assistant software is supplied with your phone on the CD-ROM, or it can be downloaded from www.panasonicmobile.com.

Follow the instructions provided to install the Data Connection Assistant.

Note: Select Other/Skip modem install for operation with Bluetooth®.

Once the Data Connection Assistant is installed you need to set up a connection to your Bluetooth® modem:

- ▶ Select **Start > Programs > Panasonic Data Connection Assistant > Data Connections**.

If you are using a circuit switched connection:

- ▶ Select Make New Connection.
- ▶ Select Modem - (Panasonic X70 or Bluetooth® COM port from the Select a Device window).
- ▶ Enter the phone number for your Internet Service Provider (ISP).

If you are using a GPRS connection:

- ▶ Select Make New GPRS Connection (GPRS).
- ▶ Select Modem - (Panasonic X70 or Bluetooth® COM port from the Select a Device window).
- ▶ Enter the Access Point Name (APN) supplied by your GPRS network operator.

Note: With some Bluetooth® USB adaptors you may need to add a modem on the correct COM port for the Data Connection Assistant. To do this on your computer select Start > Settings > Control Panel > Phone and modem options > Add > COMn, where n is the Bluetooth® COM port number.

Setting your computer's dial up connection

From your web browser:

- ▶ Select Start > Program > Panasonic Data Connection Assistant
- ▶ Select the previously created data connection, then select the Connect option from the File menu.
- ▶ Enter your user name and password and select Connect.

Once connected you can:

- Browse web sites using your computer's web browser software, e.g. Internet Explorer.
- Send and receive e-mails using your e-mail software application.
- Send and receive files to and from a server connected to the Internet using FTP software.

Note: For further details see the Data Connection Assistant documentation.

Faxing from your computer via Bluetooth®

You can use Bluetooth® to connect your computer (laptop, notepad or PC) to your phone without using any cables. Your phone acts as a fax modem. You can use it for sending and receiving faxes.

Once it is set up, whenever you send a fax from your computer it will use Bluetooth® to connect to the phone, then your phone will dial the fax number.

To send and receive faxes you must subscribe to your network operator's fax service. This gives you a second number for receiving incoming faxes.

To set up your computer and phone you need to:

- Subscribe to fax service.
- Install Bluetooth® on your computer. See *Installing Bluetooth® on your computer* on page 125.
- Pair your computer with your phone. See *Pairing your computer with your phone* on page 125.
- Install fax software on your computer, e.g. WinFax Pro (www.symantec.com).
- Install the Data Connection Software on your computer. See *Installing the Data Connection Assistant software* on page 125.
- Set up your computer's fax application software to send and receive faxes via your phone. Ensure that you select the Panasonic X70 Bluetooth® modem port in your Fax application.

Infrared dialup

You can use the infrared connection to transfer information between X70 and another device with an infrared port. You can also use the infrared connection between your phone and your computer to access the Internet and to send and receive faxes from your computer.

Preparing for infrared connection

Place your phone and the other device within the effective range of the infrared connection.

- ▶ Ensure that there are no obstructions between the two devices.
- ▶ Ensure that the infrared ports of the devices point at each other.
- ▶ If you use a PC, you need to set up infrared connection on the PC.
For example, Start > Settings > Control Panel > Infrared > Options Tab > Enable Infrared Communication.



Sending objects via infrared

You can send data from **Contacts List**, **Data Folders**, **Business Card**.

For **Contacts List**, select > **Contacts List** > **Browse** > **Infrared**.

For **Data Folders**, highlight the object you want to send. Press . Select **Infrared**.

For **Business Card**, select **Organiser** > **Business Card** > **Infrared**.

Press  or  to stop the transmission at any time.

Receiving objects via infrared

From the **Connect** menu select **Receive Object**

The phone waits for incoming data from either Bluetooth® or infrared port.

To save the received data, select **Save** and choose the folder which you want to save the required data in.

Customising your phone via infrared

To customise your phone you can download ring tones, wallpapers, contacts and other data from your computer via infrared (or the USB charge data cable EB-UCX70). You can do this using the Handset Manager software on your CD-ROM.

Connecting your computer to the Internet via infrared

You can use Infrared to connect your computer (Laptop, Notepad or PC) to your phone without using any cables. Your phone acts as a modem and it can be used for connecting your computer to the Internet for web browsing, sending/receiving emails, and transferring files (FTP).

To set up your computer and phone you will need to:-

- Subscribe to CSD or GPRS service
- Install the Data Connection Assistant software on your computer. See Installing the Data Connection Assistant software on page 125.
- Set up a dial up connection on your computer to access the Internet via your phone. See Setting your computer's dial up connection on page 126.

Note: Installation instructions regarding your computer may vary depending on your computer's operating system, web browser, etc.

Faxing from your computer via Infrared

You can use Infrared to connect your computer (Laptop, Notepad or PC) to your phone without using any cables. Your phone acts as a Fax modem and it can be used for sending and receiving Faxes.

Once set up, whenever you send a Fax from your computer it will use Infrared to connect to your phone, then your phone will dial the Fax number.

To send and receive Faxes you must subscribe to your network operator's Fax service. This gives you a second phone number on which to receive incoming Faxes.

To set up your computer and phone you will need to:-

- Subscribe to Fax service
- Install Fax software on your computer such as WinFaxPro (www.symantec.com)
- Install the Data Connection Assistant software on your computer (See Installing the Data Connection Assistant software on page 125.)
- Set up your computer's Fax application software to send/receive faxes via your phone. Ensure that you select the Panasonic X70 infrared modem port in your Fax application.

USB charge data cable (EB-UCX70)

Note: This is optional kit.

You can connect your phone to your computer with the USB charge data cable (EB-UCX70) With this you can:

- Access the Internet from your computer, using your phone as a modem.
- Send and receive faxes from your computer.
- Download ring tones, wallpapers, contacts and other data to customise your phone.

You should use this in conjunction with the software on the CD-ROM.

Note: Refer to the documentation on the CD-ROM, or to the Panasonic website www.panasonicmobile.com/support/software.

Accessories

Many accessories are available for your Panasonic phone. To purchase Genuine Panasonic accessories visit www.panasonic.com/wireless.

Bluetooth® headset (EB-BHX70)



You can use a Bluetooth® Headset to make handsfree calls within approximately 33 feet of your phone.

Car charger (EB-CDX70)



Top up your battery in your vehicle by attaching this to your cigarette lighter socket.

Car holder (EB-KAX70)



This can be mounted in your vehicle to store your phone. Can be used with car charger and personal handsfree to provide basic in-car handsfree operation.

Carry case (EB-YKX70)



This hip case protects your phone, and can be attached to your belt to keep it close at hand.

Fast travel charge (EB-BHX70US)

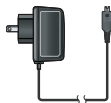

Carry this wherever you go so you can always recharge your battery.

Li-Ion battery (EB-BSX70)

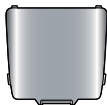

Double your talk time by having a spare battery.

Personal handsfree (EB-EMD87)



Talk and move while keeping your hands free, by using a personal handsfree. Put the ear piece in your ear and the adaptor in the side of the handset, and talk.

USB and charging data cable (EB-UCX70)



Use this to connect your phone to a PC, so you can transfer data between them. You should use this in conjunction with the software on your CD-ROM.

CD-ROM

PC Software

The CD-ROM supplied with your X70 phone contains software applications which allow you to manage the information in your phone from a Personal Computer (PC), and to enable your PC to communicate with the Internet through your phone. These applications include:

Data Connection Assistant Software

The Panasonic Data Connection Assistant Software allows you to connect a laptop or desktop PC to the Internet and other network services via your X70 mobile phone. For further information please refer to the documentation on the CD-ROM, or to the Panasonic website www.panasonicmobile.com/support/software.

X70 Handset Manager

With Handset Manager you can easily manage your phone information on a PC and synchronize it back to the phone. This information includes contacts, messages, calendar and the image or sound data held in your X70. For further information please refer to the documentation on the CD-ROM, or to the Panasonic website www.panasonicmobile.com/support/software.

Using X70 handset with X70 Handset Manager over Infra-red link.

To enable X70 handset for infra-red transfer with Handset Manager select

Main Menu > Organiser > Connect > Infrared Dialup

Future enhancements to X70 Handset Manager

- 1 Browse to www.panasonicmobile.com
- 2 Select region and language
- 3 Select Support > Software from the menu
- 4 Click "Handset Manager X70" logo
- 5 Follow the instructions to download the PC software upgrade



Installing the Software

The software is compatible with PCs and laptops running Microsoft Windows™ 98 or later. On most PCs the software should auto-install when the CD-ROM is inserted into the CD drive. If not, then autoplay must be manually selected in Windows Explorer. Follow the instructions that appear on the PC screen to install the software.

Troubleshooting

Please contact your dealer, if any problem persists, or if your problem is not dealt with here.

Problem	Cause	Remedy
Phone will not switch on.	The battery is not charged or correctly connected to the phone.	Check that the battery is fully charged and correctly connected to the phone.
Short battery life for a new battery.	The network you are using and the condition of the battery can affect battery life.	
	Leaving Bluetooth® on reduces standby battery life by about 20%.	Turn Bluetooth® off if you are not using it.
Short battery life for an old battery.	The battery has worn out	Replace with a new fully charged battery.
The charging indicator does not light, the battery level indicator does not appear and the phone cannot be switched on when charging.	The battery is not attached to the phone or when the battery has been deeply discharged the phone will take a short time until the indicator lights.	Leave the phone charging the battery for a few minutes before the indicator is lit and attempting to switch it on.
Battery fails to charge.	The battery is not attached to the phone.	Ensure the battery is fitted to the phone prior to commencing charging.
	Battery has been connected to the phone after the Fast Travel Charger has been switched on.	
Charge fault icon (⚡) on phone with charge LED on, while charging the battery.	The charging temperature limits have been exceeded.	Leave the charger connected. Charging will automatically resume when the temperature falls.

Problem	Cause	Remedy
Charge fault icon () on phone with charge LED off, while charging the battery.	There is a problem charging the battery.	Disconnect then reconnect the charger. If the problem persists, contact your service provider.
Calls cannot be made.	The phone is locked.	Enter the lock code to unlock the phone.
	Outgoing calls are barred	Disable the outgoing call barring, or barred dial.
	The phone is not registered to a network.	Move to a coverage area and operate your phone after it has registered with a network.
Calls cannot be made from Fixed Dial Store.		Check your SIM supports Fixed Dial. Check the Fixed Dial is switched on. Check the phone number is stored in the Fixed Dial.
Calls cannot be received.	The phone is not switched on.	Switch the phone on.
	Incoming calls are barred.	Disable the incoming call barring.
	The phone is not registered to a network.	Move to a coverage area and operate your phone after it has registered with a network.
Emergency calls cannot be made.	You are not in a GSM coverage area.	Check that the antenna symbol  is displayed – move to a coverage area and operate your phone when the antenna symbol is displayed.
Phone numbers cannot be recalled from Contacts List	The phone is locked.	Enter the lock code to unlock the phone.
	Phone number has been restricted.	Switch off restriction.

Problem	Cause	Remedy
X70 does not Discover another Bluetooth® device.	The other Bluetooth® device may not be in Discoverable mode.	Put the other device into Discoverable mode.
X70 fails to Pair with another Bluetooth® device	Incorrect Passkey entered.	Check Passkey and retry.
	X70 may already be Paired with 10 devices.	Delete a device from the Paired Devices list.
X70 is not Discovered by other Bluetooth® devices	X70 is not in Discoverable mode.	Put the X70 into Discoverable mode.
Call is terminated when closing the phone	Active Flip is enabled.	Disable Active Flip.

Important error messages

These are some of the important error messages which may be displayed.

Area Not Allowed.	Roaming in the selected area is not allowed.
Network Not Allowed.	Roaming with the selected network is not allowed.
Security Failure.	The network has detected an authentication failure because your SIM is not registered with that network – contact your service provider.
SIM Blocked/Contact service provider.	The SIM is blocked because one of the PIN/PIN2 unblocking keys (PUK/PUK2) has been entered incorrectly ten times – contact your service provider.
SIM Error.	The phone has detected a problem with the SIM – switch the phone off and then back on; if the message is still displayed contact your service provider.
SIM Invalid.	The SIM has failed one or more of the SIM personalisation checks – contact your service provider.
Function Unavailable.	The selected feature is either not supported by the SIM or is not available with the current subscription – contact your service provider.
PIN2 Invalidated.	The PIN2 is blocked permanently because the wrong PUK2 has been entered ten times, services controlled by PIN2 cannot be used – contact your service provider.
Message Rejected Store Full.	A message has been received but the message store is full – to receive messages, delete some of the currently stored messages or set messages to Auto Delete.

Phone Number Too Long (Max:20).	The edited or newly created Contacts List number is too long for the SIM.
This message cannot be stored.	The message area is full. Your messages cannot be stored until some of the currently stored messages are deleted.
VERIFICATION FAILURE.	On changing the phone lock code, verification of the new code is incorrect – retry changing the lock code with correct verification.
Incorrect LOCK CODE.	Disabling or enabling the lock code has failed due to incorrect entry of the lock code – re-enter lock code.
Incorrect PIN/PIN2/PUK/PUK2.	The entered code is incorrect – re-enter code correctly.
Auto Redial List Full.	Redial list of unsuccessfully dialed numbers is full – switch the phone off and then on again.

Glossary

APN	Access Point Name. Gateway from GRPS network to other networks, e.g. Internet.
Bluetooth®	Short range wireless connection for voice and data transfer.
CHAP	Challenge Handshake Authentication Protocol. A security feature for the GPRS network.
CSD	Circuit Switched Data. Connection method used by your phone for data services such as web browsing, e-mail and fax. In this mode your phone acts like a dial up modem with a data rate of up to 9.6 kbps. With CSD you are charged for the duration of your connection, and you cannot receive voice calls while you are using CSD. To use your phone's CSD capability you must subscribe to your network operator's CSD service.
Discover	Search for other Bluetooth® devices.
Discoverable	Allow other Bluetooth® devices to discover your device.
DTMF Tones	Dual Tone Multi-Frequency tones allow you to communicate with computerized phone systems, voice mailboxes etc.
GPRS	General Packet Radio Service. The name give to the advanced mobile packet data communications system that your phone supports. This system gives increased data rates compared to a Circuit Switched Data (CSD) connection. It is usually charged on the amount of data transferred not on the connection time. To use your phone's GPRS capability you must subscribe to your network operator's GPRS service.
GSM	Global System for Mobile Communications. The name given to the advanced digital technology that your phone uses.
ISP	Internet Service Provider.
Network Operator	The organization responsible for operating a GSM network.
Pair	Form a permanent association between two Bluetooth® devices.
PAP	Password Authentication Protocol. A security feature for the GPRS network.
Passkey	A one to sixteen digit number entered when Pairing Bluetooth® devices. Used as a security measure to prevent unauthorized Pairing. Also known as PIN, Password or Passcode by other manufacturers.

Password	Used for the control of the Call Bar. Supplied by your service provider.
PIN	Personal Identification Number used for SIM security. Supplied by your service provider. If the PIN is entered incorrectly 3 times, the PIN will be blocked.
PIN2	Personal Identification Number used for the control of Fixed Dial Store and Call Charge metering. Supplied by your service provider. If the PIN2 is entered incorrectly 3 times, the PIN2 will be blocked.
PUK/PUK2	PIN/PIN2 Unblocking Key. Used to unblock the PIN/PIN2. Supplied by your service provider. If the PUK/PUK2 is entered incorrectly 10 times, the PUK/PUK2 will be blocked.
Registration	The act of locking on to a GSM network. This is usually performed automatically by your phone.
Roaming	The ability to use your phone on networks other than your Home network.
Service Provider	The organization responsible for providing access to the GSM network.
SIM	Subscriber Identity Module. A small smart-card which stores unique subscriber and user-entered information such as Contacts List entries and Short Messages. Supplied by your service provider.
WAP	Wireless Application Protocol. The communication standard which enables you to download resources from the Internet to your phone.

Consumer update

Consumer Update on Mobile Phones

(Published by U.S. Food and Drug Administration, Center for Devices and Radiological Health, October 20, 1999.)

FDA has been receiving inquiries about the safety of mobile phones, including cellular phones and PCS phones. The following summarizes what is known—and what remains unknown—about whether these products can pose a hazard to health, and what can be done to minimize any potential risk. This information may be used to respond to questions.

Why the concern?

Mobile phones emit low levels of radiofrequency energy (i.e., radiofrequency radiation) in the microwave range while being used. They also emit very low levels of radiofrequency energy (RF), considered non-significant, when in the stand-by mode. It is well known that high levels of RF can produce biological damage through heating effects (this is how your microwave oven is able to cook food). However, it is not known whether, to what extent, or through what mechanism, lower levels of RF might cause adverse health effects as well. Although some research has been done to address these questions, no clear picture of the biological effects of this type of radiation has emerged to date. Thus, the available science does not allow us to conclude that mobile phones are absolutely safe, or that they are unsafe. However, the available scientific evidence does not demonstrate any adverse health effects associated with the use of mobile phones.

What kind of phones are in question?

Questions have been raised about hand-held mobile phones, the kind that have a built-in antenna that is positioned close to the user's head during normal telephone conversation. These types of mobile phones are of concern because of the short distance between the phone's antenna — the primary source of the RF — and the person's head. The exposure to RF from mobile phones in which the antenna is located at greater distances from the user (on the outside of a car, for example) is drastically lower than that from hand-held phones, because a person's RF exposure decreases rapidly with distance from the source. The safety of so-called "cordless phones", which have a base unit connected to the telephone wiring in a house and which operate at far lower power levels and frequencies, has not been questioned.

How much evidence is there that handheld mobile phones might be harmful?

Briefly, there is not enough evidence to know for sure, either way; however, research efforts are on-going. The existing scientific evidence is conflicting and many of the

studies that have been done to date have suffered from flaws in their research methods. Animal experiments investigating the effects of RF exposures characteristic of mobile phones have yielded conflicting results. A few animal studies, however, have suggested that low levels of RF could accelerate the development of cancer in laboratory animals. In one study, mice genetically altered to be predisposed to developing one type of cancer developed more than twice as many such cancers when they were exposed to RF energy compared to controls. There is much uncertainty among scientists about whether results obtained from animal studies apply to the use of mobile phones. First, it is uncertain how to apply the results obtained in rats and mice to humans. Second, many of the studies that showed increased tumor development used animals that had already been treated with cancer-causing chemicals, and other studies exposed the animals to the RF virtually continuously — up to 22 hours per day.

For the past five years in the United States, the mobile phone industry has supported research into the safety of mobile phones. This research has resulted in two findings in particular that merit additional study:

- 1 In a hospital-based, case-control study, researchers looked for an association between mobile phone use and either glioma (a type of brain cancer) or acoustic neuroma (a benign tumor of the nerve sheath). No statistically significant association was found between mobile phone use and acoustic neuroma. There was also no association between mobile phone use and gliomas when all types of gliomas were considered together. It should be noted that the average length of mobile phone exposure in this study was less than three years. When 20 types of glioma were considered separately, however, an association was found between mobile phone use and one rare type of glioma, neuroepitheliomatous tumors. It is possible with multiple comparisons of the same sample that this association occurred by chance. Moreover, the risk did not increase with how often the mobile phone was used, or the length of the calls. In fact, the risk actually decreased with cumulative hours of mobile phone use. Most cancer causing agents increase risk with increased exposure. An ongoing study of brain cancers by the National Cancer Institute is expected to bear on the accuracy and repeatability of these results.¹
- 2 Researchers conducted a large battery of laboratory tests to assess the effect of exposure to mobile phone RF on genetic material. These included tests for several kinds of abnormalities, including mutations, chromosomal aberrations, DNA strand breaks, and structural changes in the genetic material of blood cells called lymphocytes. None of the tests showed any effect from the RF except for the micronucleus assay, which detects structural effects on the genetic material. The cells in this assay showed changes after exposure to simulated cell phone radiation, but only after 24 hours of exposure. It is possible that exposing the test cells to radiation for this long resulted in heating. Since this assay is known to be sensitive to heating, heat alone could have caused the abnormalities to occur. The data already in the literature on the response of the micronucleus assay to RF are conflicting. Thus, follow-up research is necessary.²

FDA is currently working with government, industry, and academic groups to ensure the proper follow-up to these industry-funded research findings. Collaboration with the Cellular Telecommunications Industry Association (CTIA) in particular is expected to lead to FDA providing research recommendations and scientific oversight of new CTIA-funded research based on such recommendations.

Two other studies of interest have been reported recently in the literature:

- 1 Two groups of 18 people were exposed to simulated mobile phone signals under laboratory conditions while they performed cognitive function test. There were no changes in the subjects' ability to recall words, numbers, or pictures, or in their spatial memory, but they were able to make choices more quickly in one visual test when they were exposed to simulated mobile phone signals. This was the only change noted among more than 20 variables compared.³

- 2 In study of 209 brain tumor cases and 425 matched controls, there was no increased risk of brain tumors associated with mobile phone use. When tumors did exist in certain locations, however, they were more likely to be on the side of the head where the mobile phone was used. Because this occurred in only a small number of cases, the increased likelihood was too small to be statistically significant.⁴

In summary, we do not have enough information at this point to assure the public that there are, or are not, any low incident health problems associated with use of mobile phones. FDA continues to work with all parties, including other federal agencies and industry, to assure that research is undertaken to provide the necessary answers to the outstanding questions about the safety of mobile phones.

What is known about cases of human cancer that have been reported in users of handheld mobile phones?

Some people who have used mobile phones have been diagnosed with brain cancer. But it is important to understand that this type of cancer also occurs among people who have not used mobile phones. In fact, brain cancer occurs in the U.S. population at a rate of about 6 new cases per 100,000 people each year. At that rate, assuming 80 million users of mobile phones (a number increasing at a rate of about 1 million per month), about 4800 cases of brain cancer would be expected each year among those 80 million people, whether or not they used their phones. Thus it is not possible to tell whether any individual's cancer arose because of the phone, or whether it would have happened anyway. A key question is whether the risk of getting a particular form of cancer is greater among people who use mobile phones than among the rest of the population. One way to answer that question is to compare the usage of mobile phones among people with brain cancer with the use of mobile phones among appropriately matched people without brain cancer. This is called a case-control study. The current case-control study of brain cancers by the National Cancer Institute, as well as the follow-up research to be sponsored by industry, will begin to generate this type of information.

What is FDA's role concerning the safety of mobile phones?

Under the law, FDA does not review the safety of radiation-emitting consumer products such as mobile phones before marketing, as it does with new drugs or medical devices. However, the agency has authority to take action if mobile phones are shown to emit radiation at a level that is hazardous to the user. In such a case, FDA could require the manufacturers of mobile phones to notify users of the health hazard and to repair, replace or recall the phones so that the hazard no longer exists.

Although the existing scientific data do not justify FDA regulatory actions at this time, FDA has urged the mobile phone industry to take a number of steps to assure public safety. The agency has recommended that the industry:

- support needed research into possible biological effects of RF of the type emitted by mobile phones;

Consumer update

- design mobile phones in a way that minimizes any RF exposure to the user that is not necessary for device function; and
- cooperate in providing mobile phone users with the best possible information on what is known about possible effects of mobile phone use on human health.

At the same time, FDA belongs to an interagency working group of the federal agencies that have responsibility for different aspects of mobile phone safety to ensure a coordinated effort at the federal level. These agencies are:

- National Institute for Occupational Safety and Health
- Environmental Protection Agency
- Federal Communications Commission
- Occupational Health and Safety Administration
- National Telecommunications and Information Administration

The National Institutes of Health also participates in this group.

In the absence of conclusive information about any possible risk, what can concerned individuals do?

If there is a risk from these products — and at this point we do not know that there is — it is probably very small. But if people are concerned about avoiding even potential risks, there are simple steps they can take to do so. For example, time is a key factor in how much exposure a person receives. Those persons who spend long periods of time on their hand-held mobile phones could consider holding lengthy conversations on conventional phones and reserving the hand-held models for shorter conversations or for situations when other types of phones are not available.

People who must conduct extended conversations in their cars every day could switch to a type of mobile phone that places more distance between their bodies and the source of the RF, since the exposure level drops off dramatically with distance. For example, they could switch to

- a mobile phone in which the antenna is located outside the vehicle,
- a hand-held phone with a built-in antenna connected to a different antenna mounted on the outside of the car or built into a separate package, or
- a headset with a remote antenna to a mobile phone carried at the waist.

Again, the scientific data do not demonstrate that mobile phones are harmful. But if people are concerned about the radiofrequency energy from these products, taking the simple precautions outlined above can reduce any possible risk.

Where can I find additional information?

For additional information, see the following websites:

- Federal Communications Commission (FCC)
RF Safety Program (select “Information on Human Exposure to RF Fields from

Cellular and PCD Radio Transmitters”):

<http://www.fcc.gov/oet/rfsafety>

- World Health Organization (WHO) International Commission on Non-Ionizing Radiation Protection (select Qs & As): <http://www.who.int/peh-emf>
- United Kingdom, National Radiological Protection Board: <http://www.nrpb.org.uk>
- Cellular Telecommunications Industry Association (CTIA):
<http://www.wowcom.com>
- U.S. Food and Drug Administration (FDA) Center for Devices and Radiological Health: <http://www.fda.gov/cdrh/consumer/>

-
- 1 Muscat et al. “Epidemiological Study of Cellular Telephone Use and Malignant Brain Tumors”. In: State of the Science Symposium; 1999 June 20; Long Beach, California.
 - 2 Tice et al. “Tests of mobile phone signals for activity in genotoxicity and other laboratory assays”. In: Annual Meeting of the Environmental Mutagen Society. March 29,1999, Washington, D.C. and personal communication, unpublished results.
 - 3 Preece, AW, Iwi, G, Davies-Smith, A, Wesnes, K, Butler, S, Lim, E, and Varey, A. “Effect of a 915-MHz simulated mobile phone signal on cognitive function in man”. Int. J. Radiat. Biol., April 8, 1999.
 - 4 Hardell, L, Nasman, A, Pahlson, A, Hallquist, Aand Mild, KH. “Use of cellular telephones and the risk for brain tumors: a case-control study”. Int. J. Oncol., 15: 113-116, 1999.

Specifications

Bands supported	GSM900 Class 4, GSM1800 Class 1 GSM1900
Standby Time	75 – 250 hours
Standby Time (Bluetooth® on)	60 – 170 hours
Talk Time	1.5 – 5 hours
Talk Time (using Bluetooth®)	1.4 – 4.6 hours

Note: Talk and Standby time are dependant upon network conditions, SIM usage, battery condition and LCD backlight setting.

Temperature Range

Charging	+41°F - +95°F (+5° - +35°C)
Storage	-4°F - +140°F (-20° - +60°C)
Weight	3.35oz (95g) (including battery)
Dimensions	
Height	3.46 " (88 mm)
Width	1.89 " (48 mm)
Depth	0.94 " (24 mm)
Supply Voltage	3.7 V DC, 680 mAh Li-ion
Antenna	Fixed
Charge Time	Up to 120 min.

Note: Charging time is dependant on usage and battery condition.

SIM Type	3 V only
Contacts List Memory	500 + SIM
Animation Themes	2
Memo & Dictaphone	4 x 14 seconds
Games	4
Backlight colours	8
Ringtones	15 Fixed (depends on Data Folder)
Schedule	Up to 100 entries
Alarms	4

Graphics Formats Supported	GIF87a, GIF89, JPEG, WBMP, BMP, PNG
Maximum File Download Size	100 Kb
Maximum File Storage	4 Mb
Audio Formats Supported	MIDI, iMelody, AMR, SMAF, WAV

Note: Limitation of MIDI: Format 0 and 1 are supported
Limitation of SMAF: 16 polyphonic SMAF
Limitation of WAV: "CD quality" WAV (16 bit Linear PCM/44.1kHz/stereo) is not supported. Only the following formats are supported:
8 bit Linear PCM/4 kHz/mono
8 bit Linear PCM/8 kHz/mono
16 bit Linear PCM/4 kHz/mono
16 bit Linear PCM/8 kHz/mono

Bluetooth® Version	1.1
Bluetooth® Class	2
Bluetooth® Range	up to 33 feet
Bluetooth® Profiles	Headset, Handsfree, DUN, OBEX FAX
WAP 1.2.1 protocol stack	

Warranty

PANASONIC DIGITAL COMMUNICATIONS AND SECURITY COMPANY
DIVISION OF MATSUSHITA ELECTRIC CORPORATION OF AMERICA
2 Panasonic Way, 2H-2, Secaucus, New Jersey 07094

CELLULAR TELEPHONE PRODUCTS

Limited Warranty

Panasonic Digital Communications and Security Company (referred to as the "Warrantor") will repair or replace this product with new or refurbished parts or product, at Panasonic's sole option, free of charge, in the U.S.A. in the event of a defect in materials or workmanship from the date of original purchase as follows:

HANDHELD CELLULAR TELEPHONE (except description as follows) - For one (1) year.

ACCESSORIES (packaged with the Handheld Kit) - For one (1) year.

ACCESSORIES (packaged separately) - Refer to the warranty statement printed on or included in the accessory package.

To exercise your warranty return the product and a copy of the original dated purchase receipt, pre-paid, to Panasonic at the address as follows.

Please be sure to include your return address and a description of the alleged defect.

Panasonic Cellular Service Repair

14800 FAA Blvd., Suite 100
Fort Worth, TX 76155

Panasonic strongly recommends that the product be adequately packaged to avoid shipping damage. You may also want to insure the product.

Panasonic will return the repaired product pre-paid to you at your U.S.A. address.

This warranty is extended only to the original purchaser. A valid purchase receipt or other proof of date of original purchase will be required before warranty service is rendered.

This warranty covers only failures due to defects in materials or workmanship that occur during normal use. It does not cover damage that occurs in shipment, failures that are caused by products not supplied by Panasonic, failures that result from accident, misuse, abuse, neglect, water damage, mishandling, misapplication, faulty installation, setup adjustments, improper maintenance, alteration, improper antenna, inadequate signal pickup, maladjustment of consumer controls, line power surge, lightning damage, modification or service by anyone other than a Panasonic Authorized Servicer or damage that is attributable to acts of God. Removal and re-installation costs are not covered by this warranty nor are products on which the serial number is missing, altered or made illegible.

LIMITS AND EXCLUSIONS

There are no express warranties except as set forth hereinbefore.

WARRANTOR SHALL NOT BE LIABLE FOR INCIDENTAL OR CONSEQUENTIAL DAMAGES RESULTING FROM THE USE OF THIS PRODUCT, OR ARISING OUT OF ANY BREACH OF THIS WARRANTY. ALL EXPRESS AND IMPLIED WARRANTIES, INCLUDING THE IMPLIED WARRANTIES OF MERCHANTABILITY AND FITNESS FOR A PARTICULAR PURPOSE, ARE LIMITED TO THE APPLICABLE WARRANTY PERIODS SET FORTH HEREINBEFORE. Some states do not allow the exclusion or limitation of incidental or consequential damages, or limitations on how long an implied warranty lasts, so the above exclusions or limitations may not apply to you.

This warranty gives you specific legal rights and you may also have other rights which vary from state to state.

If a problem is not handled to your satisfaction, then write the Consumer Affairs Division at the company address indicated hereinbefore or contact Panasonic at Tel: 1-800-414-4408. or TTY: 1-770-338-6204.

Licensing

Bluetooth®

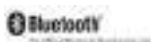

The Bluetooth® word and mark are owned by the Bluetooth® SIG, Inc. and any use of such marks by Panasonic is under license. Other trademarks and trade names are those of their respective owners.

iN-FUSiO



iN-FUSiO have developed specific software called ExEn for the purpose of downloading and playing games from mobile handset.

iN-FUSiO is a trademark or registered trademark of iN-FUSiO, France.

Tegic

T9® is a trademark of Tegic Communications Inc. T9® Text Input is licensed under one or more of the following: U.S. Pat Nos. 5,818,437, 5,953,541, 5,187,480, 5,945,928, and 6,011,554; Canadian Pat No. 1,331,057; United Kingdom Pat No. 2238414B; Hong Kong Standard Pat. No. HK0940329; Republic of Singapore Pat No. 51383; Euro. Pat No. 0 842 463 (969272260.8) DE/DK,FI, FR, IT, NL, PT, ES, SE, GB: and additional patents are pending worldwide.

CP8 Patent

Panasonic Mobile Communications Co., Ltd. 2003.

Information in this document is subject to change without notice. No part of these instructions may be reproduced or transmitted in any form or by any means without obtaining express permission from Panasonic Mobile Communications Co., Ltd.



This product is licensed under one or more of the following U.S.

Patents:4,675,863,4,777,633,4,779,262,4,785,450,4,811,420,4,817,089,4,912,705,5,022,024,5,119,375,5,121,391,5,159,705,5,657,358,5,687,194,5,734,678

This product may be protected under one or more of the following U.S. Patents: 5,842,129,5,504,803, and 5,483,666 and other patents that are pending.

Personal settings and notes

Use the table below to record your GSM/GPRS WAP settings.

Item	Provisioning Information Setting No 1	Provisioning Information Setting No 2	Provisioning Information Setting No 3	Provisioning Information Setting No 4	Provisioning Information Setting No 5
Name					
Home URL					
Linger Time					
Gateway IP					
Security	Non secure/ Secure (Delete One)				
Bearer Type					
Circuit Switched (GSM)					
Digital Dial #					
Analogue Dial #					
Circuit Type					
User ID					
User Password					
Packet Switched (GPRS)					
Access Point Name					
User ID					
User Password					
Authentication	Normal/ Encrypted/ None (PAP) (Chap)				

Notes

The Serial Number can be found on the outside of the phone under the battery. For your convenience we recommend that you note the following details as a record of your purchase.

Part Number	
Serial Number	
Dealer Name	
Purchase Date	

Index

A

- Active flip 45
- Adjusting the time difference
 - Automatically 47
 - Manually 47
- Alarm
 - Disabling 119
 - Setting 119
- All calls details 49
- Answer key 44
- Answering a call 27
 - By opening the phone ... 45
 - Handsfree 27
- Auto answer 43
- Automatic power off 47
- Automatic power on 47

B

- Backlight time 39
- Barred dial
 - Disabling 55
 - Enabling 55
- Battery
 - Charging 16
 - Fitting 15
 - Removing 15
- Bluetooth®
 - Discover and pair 122
 - Headset 19
 - Make discoverable 123
 - Paired devices 123
 - Sending a picture 103
 - Sending a sound 106
- Bookmarks
 - Adding 70
 - Deleting 70

- Grouped 71
- Grouping 72
- Renaming 70
- Broadcasts
 - Message list 92
 - Off 92
 - On 92
 - Selecting topics 92
- Browser
 - Menu 69
 - Server list 68
 - Settings 71
- Browser images
 - Disabling 72
 - Enabling 72
- Business card
 - Entering details 114

C

- Calculator 118
- Calendar on idle screen 39
- Call bar
 - Cancelling 53
 - Current status 54
 - Setting 53
- Call waiting status 49
- Caller ID 30
- Caller's ID status 49
- Camera
 - Capture mode 79
 - Close up 77
 - Tones 45
 - Zoom 77
- Camera image
 - Brightness adjustment ... 77
 - Capture mode 79
 - Effect 78

Format 78
 Frame 78
 Resolution 78
 Twilight mode 78
 Camera mode 17, 73
 Case screen 39
 Backlight colour 40
 Clock 40
 Contrast 40
 Orientation 40
 Changing your network 56
 Choosing your answer key .. 44
 Clock
 Away clock display 47
 Changing location 47
 Display format 47
 Home area 46
 On idle screen 39
 Set time 46
 Set time difference 47
 Summertime 46
 Composing a melody 42
 Contacts list
 Browsing 60
 New entry 58
 Cookies
 Deleting 72
 Disabling 72
 Enabling 72
 Copying
 Picture 102
 Sound 105
 Creating a ring type 42
 Currency converter
 Converting a value 114
 Initial conversion rate ... 114
 Reversing rates 114

D

Deleting
 Downloaded files 108
 Holiday reminder 117
 Memo 120
 Picture 77, 102
 Reminder 116
 Sound 105
 Display brightness 38
 Display icons 23
 Display language 45
 Diverts
 Cancelling 52
 Current status 52
 Setting 52
 Downloading ringtones 109
 Downloading wallpapers ... 109
 DTMF tones
 Length 45
 Sending 27
 Duration
 All calls 48
 Last call 48

E

Ear piece volume 31
 Editing
 Sound 104
 Text 37
 User messages 46
 e-mail
 Creating a message 96
 Encode 95
 Message status 97
 Received messages options . 98
 Receiving a message 97
 Send options 95
 Sending a message 97

- Server list 94
- Emergency calls 28
- Ending calls 27

F

- Faxing 126, 128
- Fixed dial
 - Disabling 55
 - Enabling 55

G

- Games
 - Embedded 66
- Greeting 38
- Groups 61

H

- Handheld to handsfree 31
- Handsfree to handheld 31
- Holding a call 31
- Hotkey dialling 30, 63

I

- Icons 23
- Idle screen calendar 39
- Image
 - Brightness 75
 - Effects 76
 - Format 76
 - Frame 76
 - Size 76
 - Trim 76
- Image properties 103
- Images as a slide show 103
- In call options 34
- Incoming calls
 - During data transfer 50
 - In camera mode 75

Infrared

- Preparing for connection 127
- Sending a picture 102
- Sending a sound 105
- Sending data 127
- International calls 28
- Internet connection 124

K

- Key backlight 39
- Key tone 44
- Key volume 44
- Keypad 44

L

- Last call details 49
- Low battery warning 16

M

- Making a second call 31
- Making calls 17, 27
- Managing your inbox 99
- Managing your outbox 99
- Manipulating folders 108
- Melody composer 42
- Memo 119
 - Deleting 120
 - Play back 120
 - Recording a conversation 120
- Menu shortcuts 26
- MMS
 - Configuring 81
 - Creating a message .. 19, 83
 - Entering user messages .. 84
 - Messages status 86
 - Outbox 87, 98
 - Player mode 82
 - Reading messages 86

Receive options 82
 Send options 82
 Sending a picture 101
 Sending a sound 104
 Moving
 Picture 102
 Sound 105
 Multi shot 79
 Multi-party calls 33
N
 New contact 58
 Notepad 34
P
 Password 54
 Phone defaults 56
 Phone lock
 Cancelling 52
 Changing the code 53
 Setting 52
 Phone off 17
 Phone on 17
 Picture
 As wallpaper 103
 Brightness 75
 Effects 76
 Format 76
 Frame 76
 Size 76
 Trim 76
 PIN
 Changing 55
 Disabling 54
 Enabling 54
 PIN2
 Disabling 54
 Enabling 54
 Playing a sound 104

Q

Quiet mode 18, 41

R

Receive object 124, 127
 Receiving a second call 32
 Rejecting a call 28
 Reminder
 Creating 116
 Deleting 116
 Deleting holiday reminder 117
 Holiday reminder 117
 Viewing 116
 Remote 79
 Renaming
 Picture 77
 Sound 105
 Resuming a call 31
 Returning to default settings 56
 Ring type 18, 41, 106
 Ring volume 41
 Roaming 56

S

Safety first 5
 Saving a picture 75
 Schedule
 Changing the layout 118
 Jumping to a date 118
 Self timer 79
 Self-portrait 74
 Shortcut key 43
 SIM
 Fitting 14
 Removing 14
 Single shot 79
 Slide show 103, 108

SMS

- Auto delete 88
- Chat 92
- Creating a message .. 19, 89
- Message centre 88
- Message lifetime 89
- Message options 90
- Message receipt 89
- Outbox 91
- Protocol 89
- Receiving a message 90
- Recipient group 88
- User messages 90

Sound

- As a ring type 106
- Properties 106

Start up animation 38

Status icons 23

Swapping between calls 32

Synchronizing

- Contacts list 112
- Schedule 113

T

T9® 36

- Adding to dictionary 36

Taking a picture 17, 74

Tegic language 45

Text

- Copying 37

- Cutting 37

- Editing 36

- Pasting 37

Text language 45

Theme properties 107

Transferring a call 32

Turning tones off 45

Turning tones on 45

U

Using a theme 107

V

Vibration alert 42

Viewing a picture 100

Voice mail 98

Voice message 43

W

Wallpaper 18, 38, 103

Wild numbers 59

Withhold ID status 49

Reference

For future reference, please complete the information on this page. Also, you may want to tape or staple your purchase receipt here.

Model Number: _____

IMEI Number (under battery on back of phone): _____

Purchase Date: _____

Dealer's Name: _____

Dealer's Address: _____

Dealer's Phone Number: _____

Emergency Number: _____

Lock Code: _____

To order this manual in Spanish
(part number 3TR001403AAA),
call our toll free number 1 (800) 833-9626.
Si desea hacer su pedido de la versión en español
(No. catálogo 3TR001403AAA) de este manual,
llame sin costo al 1(800) 833-9626.

Before operating this phone, please read these instructions completely. Charge battery before operation.



Panasonic Digital Communications & Security Company
Division of Matsushita Electric Corporation of America
2 Panasonic Way, 2H-2
Secaucus, NJ 07094



3790024758AA

©2004 by Panasonic Mobile Communications Co., Ltd.
All rights reserved. Unauthorized copying and distribution
is a violation of the law.
Published 2004

