

au by KDDI

# WOO ケータイ

## H001

### Basic Manual

READ THIS MANUAL TO MASTER  
THE CELLULAR PHONE

[www.au.kddi.com](http://www.au.kddi.com)

Illustrations and  
Screenshots  
in This Manual

Notes on  
Cell Phone Use

Contents

Getting Ready

Making and  
Answering Calls

Global Functions

Character Input

Phone Book

Pair Function

Mail

Camera

EZweb

EZ News Flash/  
au one Gadget

EZ Navi

TV (1Seg)

In Case of  
Loss of Your H001

Troubleshooting

Index

# Introduction

Thank you for purchasing the H001. Before using your H001, be sure to read the H001 Basic Manual (this PDF manual) to ensure correct usage. After you have finished reading this manual, store this PDF manual and the printed manuals in safe places so you can retrieve them whenever you need them.

## Manuals for the H001

The H001 comes with the Basic Manual and Instruction Manual.

### ● For learning the basics:

Read the H001 Basic Manual (this manual).

### ● For learning details on using each function:

Read the supplied H001 Instruction Manual (Japanese). Be sure to read the Safety Precautions “安全上のご注意” to ensure proper usage of the H001.

The keyword searchable au Online Manual is also available on the au homepage:

<http://www.au.kddi.com/manual/index.html>

- To access from EZweb:  ⇒ *au one Top* ⇒ *auお客さまサポート* (au Customer Support) ⇒ *オンラインマニュアル* (Online Manual)

Scan this QR code to access the au Online Manual. ▶



# Illustrations and Screenshots in This Manual

## Note on Illustrations

The illustrations in this manual may look different from the actual cell phone in shape, color and typeface. The key illustrations are also simplified as shown below.

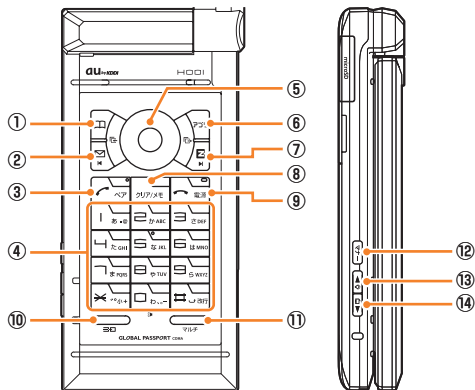

| Key Illustration |  | Key Illustration |  |
|------------------|--|------------------|--|
| ①                |  | ⑧                |  |
| ②                |  | ⑨                |  |
| ③                |  | ⑩                |  |
| ④                |  | ⑪                |  |
|                  |  |                  |  |
|                  |  |                  |  |
|                  |  |                  |  |
| ⑤                |  | ⑫                |  |
| ⑥                |  | ⑬                |  |
| ⑦                |  | ⑭                |  |

## Note on Screenshots

The screenshots in this manual are simplified and may look different from the actual cell phone screens.

- The display design themes of the H001 vary by model color. The screenshots for the Flame Red models are used in this manual.

## Notes on Cell Phone Use

### Cell Phone Etiquette

The cell phone always emits weak radio waves when power is on.

Use the cell phone in an enjoyable and safe manner without forgetting to be considerate of others around you.

- **Use of cell phones is not allowed in some places.**
  - Do not use the cell phone while you are driving. Doing so is both dangerous and prohibited by law.
  - Using a cell phone in an aircraft is prohibited by law. Be sure to turn the cell phone off.
- **Radio waves from cell phones may interfere with medical electrical equipment.**
  - Some people close to you in crowded places such as packed trains may be using a cardiac pacemaker. Turn the cell phone off in such places.
  - Abide by the rules of hospitals and other medical institutions where it is forbidden to use or carry cell phones.
- **Be considerate of where you use the cell phone and how loudly you talk.**
  - Do not make calls in theaters, museums, libraries, and other similar places. Turn power off or turn on manner mode not to disturb others around you by ring tones.
  - Do not use the cell phone on a street where you might interrupt the flow of pedestrians.
  - Move to areas where you will not inconvenience others on trains or in hotel lobbies.
  - Refrain from talking in a loud voice.

- Obtain the permission of other people before you take their photos with the cell phone's camera.
- Do not record information with the cell phone's camera in bookstores and other locations where taking photos is not permitted.

### Do Not Use the Cell Phone While Driving!

**Turn off your cell phone or put it in Drive Mode while driving.**



Do not use the cell phone while driving a car/motorcycle or riding a bicycle. It may result in a traffic accident. Using a cell phone while driving is prohibited by law. Using a cell phone while riding a bicycle may also be punishable by law.

#### Prohibited!

- Looking at a cell phone display
- Talking on a cell phone while holding it

#### Drive Mode

In Drive Mode, a Japanese message meaning "I'm driving now, so I can't answer your call." is played when a call is received, and asks the caller to leave a message on the answer memo.

When the standby screen is displayed, press , use  to select *Drive*, and then press  (Set).

## Disaster Message Board Service

When a big scale disaster occurs, you can register your safety information from EZweb. The registered information can be referred from anywhere in Japan from EZweb or Internet.

### Registering safety information

- When a big scale disaster occurs, from an au phone, you can register your safety information (i.e. your condition and comments) to the 災害用伝言板 (Disaster Message Board) created on the EZweb.
- After registration of your safety information, e-mail is sent to your family or acquaintances you have previously designated to notify that your safety information has been uploaded to the 災害用伝言板 (Disaster Message Board).

### Inquiring for safety information

- You can inquire for safety information of a person by entering his/her phone number from EZweb or Internet.\*  
\* To inquire from other carriers' cell phone, a PHS or PC, access "<http://dengon.ezweb.ne.jp/>".

|        |   |
|--------|---|
| Access | ☰ ⇒ <i>au one Top</i> ⇒ 災害用伝言板 (Disaster Message Board)             |
|        | <a href="http://dengon.ezweb.ne.jp/">http://dengon.ezweb.ne.jp/</a> |

- The maximum storage period of the registered information is 72 hours.
- The maximum available number of registrations is 10 per phone number. When the number of registrations exceeds 10, the oldest one is overwritten.
- The demonstration of this service can be referred to anytime by pressing ☰ ⇒ *au one Top* ⇒ *auお客様サポート* (au Customer Support) ⇒ 調べる (Search) ⇒ 災害用伝言板 (デモ版) (Disaster Message Board (Demo Version)).
- To view the Disaster Message Board in English, select *English* from the top menu of the Disaster Message Board.

# Contents

## Introduction

### Illustrations and Screenshots in This Manual 1

### Notes on Cell Phone Use 2

|   |   |
|---|---|
| Cell Phone Etiquette .....                    | 2 |
| Do Not Use the Cell Phone While Driving!..... | 2 |
| Disaster Message Board Service .....          | 3 |

### Contents 4

### Getting Ready 6

|   |    |
|---|----|
| Checking the Contents of the Box .....            | 6  |
| Names of Parts .....                              | 7  |
| Position of H001 .....                            | 8  |
| Using 3D .....                                    | 9  |
| Charging the Battery Pack .....                   | 10 |
| Learning the Basics .....                         | 11 |
| Turning On Power .....                            | 12 |
| Switching the Display Language to English .....   | 12 |
| Initial Setup of E-mail and EZweb .....           | 12 |
| Checking Your Phone Number and E-mail Address ... | 12 |
| Display Indicators .....                          | 13 |
| Using Main Menu .....                             | 14 |
| Using Wide Open Menu .....                        | 16 |
| Changing Your E-mail Address .....                | 17 |
| Security Code and Passwords .....                 | 18 |

### Making and Answering Calls 19

|  |    |
|--|----|
| Making a Call .....                                      | 19 |
| Making an International Call.....                        | 19 |
| Answering a Call .....                                   | 20 |
| Returning a Call (Outgoing History/Incoming History) ... | 21 |
| One-ring Calls.....                                      | 21 |
| Adjusting the Earpiece Volume during a Call .....        | 21 |
| Turning On Manner Mode.....                              | 21 |
| Changing the Incoming Ring Tone .....                    | 22 |
| Adjusting the Incoming Ring Tone Volume .....            | 22 |
| Turning On the Answer Memo .....                         | 23 |

### Global Functions 24

|                                      |    |
|--------------------------------------|----|
| Setting Area .....                   | 24 |
| Calling to Japan from Overseas ..... | 24 |

### Character Input 25

|  |    |
|--|----|
| Character Entry Modes .....            | 25 |
| Entering Alphanumeric Characters ..... | 25 |
| Entering E-mail Addresses .....        | 26 |
| Entering Pictograms .....              | 27 |

### Phone Book 28

|  |    |
|--|----|
| Saving a Phone Book Entry .....                                      | 28 |
| Dialing from the Phone Book .....                                    | 28 |
| Editing Phone Book Entries .....                                     | 28 |
| Saving a Phone Number from the Incoming<br>or Outgoing History ..... | 29 |

|  |           |   |           |
|--|-----------|---|-----------|
| <b>Pair Function</b>   | <b>30</b> | <b>EZ News Flash/au one Gadget</b>  | <b>41</b> |
| Registering a Pair Partner .....                                   | 30        | Basic Operations .....  | 41        |
| Making a Call to a Pair Partner .....                              | 30        | Setting EZ News Flash .....   | 41        |
| Sending Mail to a Pair Partner .....                               | 30        |   |           |
| <b>Mail</b>  | <b>31</b> | <b>EZ Navi</b>  | <b>43</b> |
| Using E-mail .....   | 31        | Passenger Seat Navi for People<br>in the Passenger Seat to Check the Route .....        | 43        |
| Creating and Sending E-mail Messages .....                         | 31        | Security Navi to Check Where Your Kids Are .....  | 43        |
| Reading Received E-mail Messages .....                             | 32        | EZ Navi Walk for When You Go Out .....  | 44        |
| Reading an E-mail Message<br>with an Attached Photo or Movie ..... | 32        | Evacuate Navi to Guide You Home or to Nearby<br>Evacuation Areas during Disasters ..... | 45        |
| Replying to Received E-mail Messages .....                         | 32        |   |           |
| Rejecting Spam .....   | 33        | <b>TV (1Seg)</b>  | <b>46</b> |
| Using C-mail .....   | 34        | Initial Setup of au Media Tuner .....   | 47        |
| Creating and Sending C-mail Messages .....                         | 34        | Watching TV (1Seg) .....  | 47        |
| Reading Received C-mail Messages .....                             | 34        | Basic Operations .....  | 48        |
|  |           | Viewing in Wide Open Position .....   | 48        |
|  |           | Exiting the au Media Tuner .....  | 48        |
| <b>Camera</b>  | <b>35</b> | <b>In Case of Loss of Your H001</b>   | <b>49</b> |
| Photo Taking Tips .....  | 35        | Setting Conditions for Activating the Remote Ctrl Lock .....                            | 49        |
| About Photo Modes .....  | 35        | Remotely Activating the Remote Ctrl Lock on Your H001 ...                               | 49        |
| Taking a Photo .....   | 36        | Activating the Remote Ctrl Lock<br>by the Security Lock Service .....                   | 50        |
| Viewing Photos .....   | 36        |   |           |
| <b>EZweb</b>   | <b>37</b> | <b>Troubleshooting</b>  | <b>51</b> |
| Accessing Sites .....  | 38        | <b>Index</b>  | <b>53</b> |
| Bookmarking Frequently Accessed Pages .....                        | 39        |   |           |
| Viewing Bookmarked Pages .....                                     | 39        |   |           |
| Checking Charges .....   | 40        |   |           |
| Downloading Chaku-Uta-Full®/Chaku-Uta® .....                       | 40        |   |           |

# Getting Ready

## Checking the Contents of the Box

The box contains the cell phone and accessories.

- Cell phone
- Battery pack

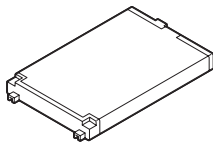
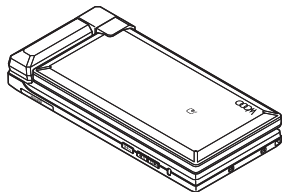

- CD-ROM
- Instruction Manual (Japanese)
- Warranty (Japanese)
- Safety Precautions (Japanese)
- Global Passport CDMA Owner's Guide (Japanese)
- Osafu-Keitai® Guide (Japanese)
- JIBUN BANK Launcher Operation Guide (Japanese)

- The following accessories are not included.

- |                       |                                    |                   |
|-----------------------|------------------------------------|-------------------|
| - microSD memory card | - Desktop holder                   | - AC adapter      |
| - USB cable           | - Earphone jack conversion adapter | - Stereo earphone |

Purchase a common AC adapter 01/02 (sold separately).



# Names of Parts

## From the Front

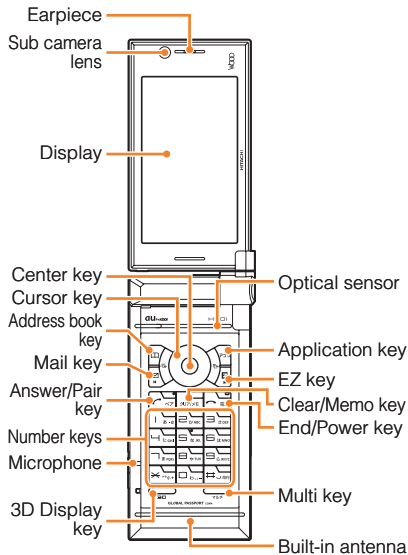

## From the Back

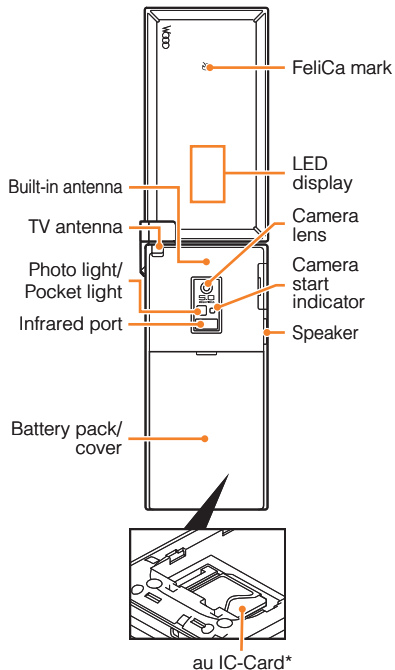

\* Do not remove this card unnecessarily as your phone number is recorded on it.

## From the Sides

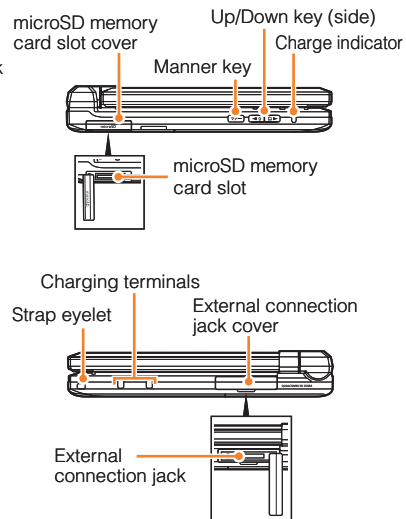

## Position of H001

H001 has two positions: Regular open position which the display part open lengthwise, and Wide open position which the display part open crosswise.

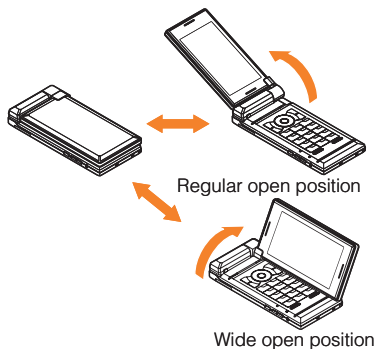

- When re-opening from Regular open position to Wide open position, or from Wide open position to Regular open position, always close your cell phone before re-opening. If you force power when your cell phone is not closed, it may cause damage.
- In Regular open position and Wide open position, do not force to close your cell phone except to the direction it closes. It may cause damage.
- When changing the position, take care not to touch the key with your fingers. It may cause malfunction.
- You can not make call in Wide open position. If you receive a call in Wide open position, re-open H001 in Regular open position before answering. In Wide open position, you can make or answer a call only when flat-type switched earphone microphone (sold separately) or flat-type stereo earphone microphone (sold separately) is attached, when a Bluetooth® device is connected by handsfree call.
- When carrying H001, close the main unit.

## Using 3D

If you press **[3D]**, movies/photos are displayed in 3D.

**Press [3D].**

- The mode will be switched to 3D. Press **[3D]** again to cancel the mode.

- Movies/photos cannot be displayed in 3D during a Voice Call, a Video Phone, a Fake Incoming Call, the Auto Lock, the Remote Ctrl Lock, a mobile UPDATE, a reset or an output period of TV (using a Casio TV Output Cable 01 (sold separately)), while you are activating the Safety Buzzer, initializing a microSD memory card, using Infrared or Bluetooth® communication, communicating in External Memory Transferring Mode (M572), decompressing Content Pack Data or EZapps Archive Data, or while the battery is low or the au one Address Book Server is being connected.
- If you switch the mode to 3D by pressing **[3D]**, some movies may not be displayed in 3D or displayed as clearly as 3D data. Try the following:
  - Keep the display facing toward yourself, and then, for clearer visibility, move the cell phone about 30 to 50 cm back and forth, or tilt the display.
  - Adjust the 3D effect in the 3D setting.
- Before seeing characters, press **[3D]** to cancel 3D.
- When playing back 3D data for Wide Open Standby, Wide Open Menu or Movie/EZ Movie, you cannot cancel 3D by pressing **[3D]**. Also, you cannot adjust the 3D effect in the 3D setting.

- Using 3D consumes more battery power than it does when 3D is not in use.
  - \* See "3DC安全ガイドライン" for more detailed precautions on using 3D safely. ⇒Visit "<http://www.3dc.gr.jp/>" (3D Consortium) from a PC.
- Watching 3D is not recommended for those who have photosensitivity, cardiac affection and those who are in poor physical condition, sleep-deprived, exhausted, under the influence of drink.
- Watching 3D long hours is not recommended. Stop using 3D if you feel exhausted or uncomfortable while watching 3D. Even if there is nothing wrong with you, taking a rest for 5 to 15 minutes every 30 to 60 minutes is recommended.
- It is not recommended to watch 3D when you are in a car or train, you are walking, or you are in an environment where the screen is not stable. Otherwise, you may feel exhausted or uncomfortable.
- Do not let small children (six years old or younger) watch 3D to prevent their eyes from growing abnormally.
- You may not be able to see 3D clearly or at all if your right or left eye's vision is quite different from the other's or your eyes do not focus equally on the screen. How clearly 3D can be seen may depend on individuals or the quality of movies that you watch.

## Charging the Battery Pack

The battery pack is not fully charged at the time of purchase. Be sure to charge the battery pack before using the cell phone for the first time.

- An AC adapter is not included. Purchase a common AC adapter 01/02 (sold separately).

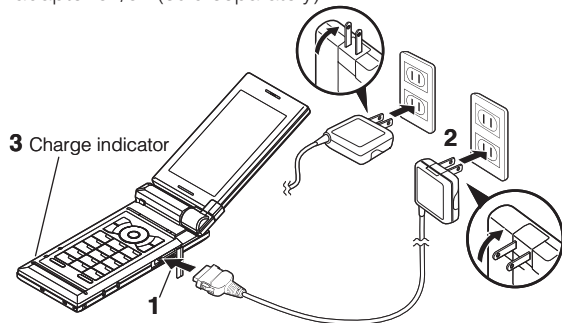

### ➔ Connect the common AC adapter 01/02 to the H001.

- Check the shape of the connector of the common AC adapter 01/02 and then plug it straight into the power terminal of the H001.

### ➔ Unfold the power plug of the common AC adapter 01/02 and plug it into a 100 V AC power outlet.

### ➔ Confirm that the charge indicator lights.

- Charging: A charge beginning sounds and the charge indicator lights.
- Charging finished: A charge completion sounds and the charge indicator goes out.

# Learning the Basics

## Key Assignments

◀ : Display Incoming History.  
 ◐ : Display Alert window/Shortcut menu.  
 ☰ : Use Phone Book.  
 ✉ : Send/receive e-mail/c-mail.  
 ☎ : Make/answer calls. Use the Pair function.  
 クリ/メモ : Set/cancel Answer memo. Delete characters. Cancel operation.  
 3D : 3D Display on/off.



⬆ : Display the ticker field, info pane and gadget (setting) icon.  
 ▶ : Display Outgoing History.  
 ● : Display Main menu.  
 アプリ : Activate EZapps.  
 EZ : Display EZ Service menu.  
 電源 : Turn power on/off. End call/communication. Cancel operation.  
 0 ~ 9 \* # : Input phone numbers and characters.  
 マルチ : Display multi play window.

## Side Key Assignments

電源 : Set/cancel manner mode.  
 ☎ : Activate Pocket light.  
 再生 : Activate au Media Tuner.

• If you lose track of where you are or if you make a mistake, press クリ/メモ to return to the previous screen. Return to the standby screen by holding down 電源 for at least one second.

## Hiding/Redisplaying the Alert Window

When the alert window is displayed on the standby screen, you can temporarily hide it by pressing  (Back) and then display the Main menu by pressing . To redisplay the hidden alert window, press  when the standby screen is displayed.

Alert window



## Turning On Power

Hold down  for at least a few seconds.

- You cannot receive or make calls if  (out of range indicator) is displayed.

## Turning Off Power







When the standby screen is displayed, hold down  for at least one second.

## Switching the Display Language to English

You can switch the display language for function names and other items to English.

When the standby screen is displayed, press .

- Use  to select **機能** (Function) and then press  (選択 [Select]).

- Use  to select **画面表示** (Screen Display) and then press  (選択 [Select]).
- Use  to select **Set Language** and then press  (選択 [Select]).
- Use  to select **English** and then press  (Set).

## Initial Setup of E-mail and EZweb

To use e-mail and EZweb, you need to apply for an EZweb subscription. If you did not apply for an EZweb subscription at the time of purchase, contact an au shop or the au Customer Service Center.

Also, before use, you need to configure initial settings. Your e-mail address is assigned automatically in the initial setup.



When the standby screen is displayed, press .

- Press  (OK).

After a short while, your e-mail address is displayed.

- Press  (OK).

The initial settings are complete.

- You can also configure initial settings by pressing  or .

## Checking Your Phone Number and E-mail Address

When the standby screen is displayed, press  and then .

# Display Indicators

Display indicators inform you of mail arrival, current settings, etc.

## Display

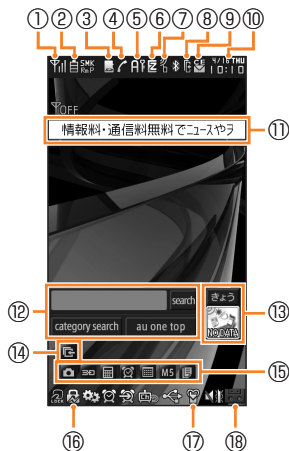

| Indicator | Description   |
|-----------|---|
| ①         | Signal strength   |
| ②         | Battery level   |
| ③         | A microSD memory card (commercially available) inserted |
| ④         | During a call   |
|           | au Media Tuner activated                                |
| ⑤         | EZapps activated  |
| ⑥         | Connecting to EZweb                                     |
| ⑦         | Receiving EZ News Flash information                     |
| ⑧         | Missed calls  |
| ⑨         | New or unread e-mail/c-mail                             |
| ⑩         | Current date and time                                   |
| ⑪         | — Ticker field  |
| ⑫         | — Search window   |
| ⑬         | — Info pane   |
| ⑭         | — Alert icon  |
| ⑮         | Shortcut menu   |
| ⑯         | Auto Lock/Side key disable feature on                   |
| ⑰         | Manner mode set   |
| ⑱         | Answer memo or manner mode set                          |

## LED display

The condition of H001 is indicated by the icon on the LED display. Also, animation will be shown in situations such as receiving a call or mail, when it gets to alarm time, and so on.

- The direction of the LED display differs depending on if the battery charger is connected or not.
- \* When the desktop holder is attached and the common AC adapter O1/O2 (sold separately) or the USB charge Cable01 (sold separately) is not connected, the display is shown in the direction of ①.

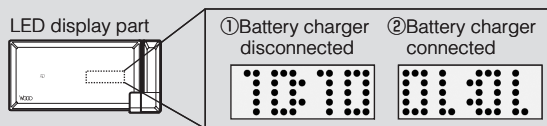

Pressing the side key (  ,  ) with the main unit closed displays the time for about five seconds. Each time you press the side key, the display indicating the condition of H001 switches in the following order.

- Only the time icon will be indicated except when the standby screen is displayed.

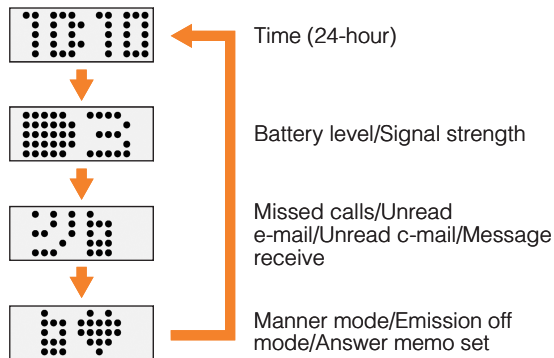



## Using Main Menu

You can access various functions from the Main menu. The Main menu patterns vary by model color. The screenshots for the Flame Red models are used in this manual.

| Model Color  | Main Menu Pattern |
|--------------|-------------------|
| Flame Red    | Solid Future      |
| Solid Silver | Silent Space      |
| Neon Purple  | Colorful Cube     |

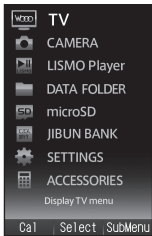

Each Main menu pattern has a different set of items.

| Solid Future  | Silent Space  | Colorful Cube   | Simple  |
|---|---|---|---|
|  |  |  |  |
| microSD   | microSD   | EZ Machi-Uta  | TV  |
| Data Folder   | Data Folder   | Uta-tomo  | CAMERA  |
| GLOBAL Function   | GLOBAL Function   | Data Folder   | LISMO Player  |
| Function  | Function  | Function  | DATA FOLDER   |
| Camera  | Camera  | au one Music  | microSD   |
| TV  | TV  | LISMO Player  | JIBUN BANK  |
| LISMO Player  | LISMO Player  | TV  | SETTINGS  |
| Watch/Calendar  | Watch/Calendar  | Camera  | ACCESSORIES   |
| JIBUN BANK  | JIBUN BANK  | au Records  |   |
| EZ FeliCa   | EZ FeliCa   | Music Search  |   |
| IrComm  | Infrared Comm   | microSD   |   |
| Accessories   | Accessories   | Accessories   |   |

## Using Wide Open Menu

The menu only for Wide open position is prepared in H001.

| Wide Open Menu  |
|---|
|  The image shows a TV(1Seg) menu icon. It features a dark background with the text 'TV(1Seg)' at the top. Below the text are several small icons representing different content types: a document, a movie, a folder, a TV set, a site viewer, and a video clip. At the bottom of the icon, it says 'Watch 1Seg TV'. |
| PC Document   |
| EZmovie   |
| Photo/Movie Folder  |
| TV(1Seg)  |
| PC Site Viewer  |
| TV rec data   |
| Video/Video Clip  |

## Changing Your E-mail Address

You can change the account name of your e-mail address.

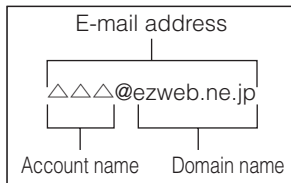

When the standby screen is displayed, press .

- ➔ Use to select *E-mail Setup* and then press (Select).
- ➔ Use to select *Other* and then press (Select).  
The cell phone connects to the server.
- ➔ Use to select *Eメールアドレスの変更* (Change E-mail Address) and then press (Select).
- ➔ Use to select the entry box, press (Input), enter your security code, and then press (OK).
  - Your security code is the four-digit number you wrote on your subscription form.
  - If the security code is incorrectly entered three times consecutively during a single day, the e-mail address change operation will be disabled until the next day.
- ➔ Use to select *送信* (Send) and then press (Select).

- ➔ Use to select *承諾する* (Accept) and then press (Select).
- ➔ Use to select the entry box, press (Input), enter an e-mail address using single-byte alphanumeric characters, and then press (OK).
  - For details on entering e-mail addresses, see page 26.
- ➔ Use to select *送信* (Send) and then press (Select).
- ➔ Use to select *OK*, press (Select) and then (OK).
  - Check that the e-mail address has been updated before pressing (OK).

- Your e-mail address cannot be changed if the new address you enter in the above procedure is already being used. In this case, enter a different e-mail address.

## Security Code and Passwords

You can use a security code and other passwords described below.

Take care not to forget your security code and passwords, because they are required for performing various operations and using subscription services.

### Security Code

|                 |  |
|-----------------|--|
| Usage Example   | <ul style="list-style-type: none"> <li>①Using the Answering Service (Voice Mail) and Call Transfer remotely from a fixed-line phone</li> <li>②Making inquiries, applications, and changes while using au Customer Service Center voice guidance, au web pages, and EZweb</li> <li>③Changing the settings of <i>Mail Filter</i> or <i>Other</i> under E-mail Setup</li> </ul> |
| Initial Setting | The four-digit number you wrote on your subscription form  |

### Lock No.

|                 |   |
|-----------------|---|
| Usage Example   | Changing various settings of the cell phone |
| Initial Setting | 1234  |

### EZ Password



|                 |  |
|-----------------|--|
| Usage Example   | Subscribing or canceling subscriptions to EZweb fee-based contents |
| Initial Setting | The four-digit number you wrote on your subscription form          |

### Premium EZ Password

|                 |  |
|-----------------|--|
| Usage Example   | <ul style="list-style-type: none"> <li>①Subscribing or canceling subscriptions to EZweb fee-based contents paid by <i>まとめてau 支払い</i> (au Collective Payment Service)</li> <li>②Purchasing products from EZweb sites using <i>まとめてau 支払い</i> (au Collective Payment Service)</li> </ul> |
| Initial Setting | The four-digit number you wrote on your subscription form  |

## Making and Answering Calls

### Making a Call

When the standby screen is displayed, use  to  to enter a phone number.

- When calling to a fixed-line phone, you also need to enter the area code.



➔ Press .

- To end the call, press .

- After you enter a phone number, you can add 184 or 186 to the phone number as follows:

➔ Press .

➔ Use  to select *Add Special No.* and then press .

➔ Use  to select *184* or *186* and then press  (Add).  
*184*: When you do not want to inform the other party of your phone number.

*186*: When you want to inform the other party of your phone number.

- You can not make call in Wide open position.

## Making an International Call

### au International Call Service

Available without any additional application



Example: To call 212-123-△△△△ in the USA

Press      .



↑  
International access code

➔ Press .

↑  
Country code (USA)

➔ Press   .

↑  
Area code

➔ Press    △△△△.

↑  
Phone number

➔ Press .

- Calling charges for this service are added to monthly cell phone calling charges and billed together.
- Check the country code at the au Customer Service Center.
- For charges, refer to au MOBILE PHONE SERVICE GUIDE or au Customer Service Center.

## 001 KOKUSAI MOBILE TALK

Application required.

For inquiries, contact the KDDI Customer Service Center.

 0077-7160

(toll-free; open 9:00 to 20:00 everyday including weekends and national holidays)

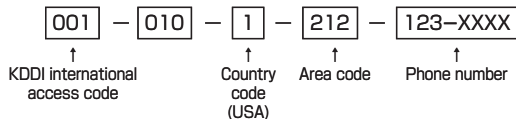

- Charges for 001 KOKUSAI MOBILE TALK are charged separately from monthly au telephone charges.
- Check the country code at the au Customer Service Center.
- For charges, refer to au MOBILE PHONE SERVICE GUIDE or au Customer Service Center.

## Answering a Call

To answer a call, press .

- To end the call, press .

- You can not make call in Wide open position.

## Display When a Call is Received

The phone number of the caller appears.



If the caller's phone number and name are in the phone book, the name is also displayed.

When the phone number of the caller is not displayed, one of the following indicators may appear.

| Indicator          | Meaning   |
|--------------------|---|
| <i>ID Unsent</i>   | The caller did not send a Caller ID.                      |
| <i>Payphone</i>    | The call is from a pay phone.                             |
| <i>Not Support</i> | The call is from a phone that does not support Caller ID. |

## Missed Call Notification

If you did not answer a call,  and *Missed Call* are displayed to let you know that you missed a call.

To check the caller's phone number, use  to select *Missed Call* and then press  (Select). You can then return the call (see page 21).

## Returning a Call (Outgoing History/Incoming History)

Example: Returning a call to a phone number in the incoming history

When the standby screen is displayed, press .

- Press  while the standby screen is displayed to display the Outgoing History screen.

➔ Use  to select the phone number you want to call and then press  (Detail).

- Press  to display the Outgoing History screen.

➔ Press .

- The cell phone can store up to 50 phone numbers in each of the incoming and outgoing history.

## One-ring Calls

### What is a One-ring Call?



A one-ring call is a call from an unknown caller that only rings once, causing it to be stored in the incoming history. One-ring calls are often used to get you to return the call, which will connect you to a dating service or some other service that charges you at high rates.

### One-ring Indicator

 indicator on the Incoming History screen indicates you have received a one-ring call (a call rang for three seconds or shorter). Be careful when you return a call to an unknown caller.

## Adjusting the Earpiece Volume during a Call



During a call, use .

- : Increases the volume.
- : Decreases the volume.

➔ Press  (OK).

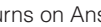

## Turning On Manner Mode

When the standby screen is displayed, hold down  for at least one second.

This turns on manner mode, and displays  and  on the standby screen. This also turns on Answer memo, which is indicated by  on the standby screen.

### Turning Off Manner Mode

















When the standby screen is displayed, hold down  for at least one second.

Turning off manner mode causes  and  to disappear from the standby screen. Answer memo is also turned off, which is indicated by  disappearing from the standby screen.

- Even in manner mode, the cell phone still emits a sound when autofocusing, a shutter sound when you take a photo.















## Changing the Incoming Ring Tone

When the standby screen is displayed, press .

- ➔ Use  to select *Function* and then press  (Select).
- ➔ Use  to select *Sound/Vib/LED* and then press  (Select).
- ➔ Use  to select *Incoming Setup* and then press  (Select).
- ➔ Use  to select *Incoming Call* and then press  (Select).
- ➔ Use  to select  (Ringtone) and then press  (Select).
- ➔ Use  to select *Original* and then press  (Select).
- ➔ Use  to select a ring tone and then press  (Set).  
The incoming ring tone is set.
  - If you press  (Play), the tone plays.
- ➔ Press  (OK).

## Adjusting the Incoming Ring Tone Volume

When the standby screen is displayed, press .

- ➔ Use  to select *Function* and then press  (Select).
- ➔ Use  to select *Sound/Vib/LED* and then press  (Select).
- ➔ Use  to select *Incoming Setup* and then press  (Select).
- ➔ Use  to select *Incoming Call* and then press  (Select).
- ➔ Use  to select  (Ringtone Volume) and then press  (Select).
- ➔ Use  to adjust the volume and then press  (Set).
  - Each press of  changes the volume one step.

|                       |   |
|-----------------------|---|
| <i>STEP</i> ↑         | The ring tone volume gradually increases. |
| <i>STEP</i> ↓         | The ring tone volume gradually decreases. |
| Level5<br>↓<br>Level1 | The ring tone sounds at the set volume.   |
| <i>OFF</i>            | The ring tone does not sound.             |

- ➔ Press  (OK).





## Turning On the Answer Memo

When the standby screen is displayed, hold down  for at least one second.

 is displayed on the standby screen.





## Turning Off the Answer Memo

When the standby screen is displayed, hold down  for at least one second. The answer memo is turned off and  disappears from the standby screen.

- The cell phone can record a maximum of ten messages, each up to 60 seconds long.
- Answer memo is a function that automatically answers calls and allows callers to record messages. Use the Answering Service (Voice Mail) when your phone is turned off or when you are in a location where a signal cannot be received.













## Playing a Message

If a message is recorded, *Answer Memo* appears on the standby screen.

- ➔ Use  to select *Answer Memo* and then press  (Select).
- ➔ Use  to select the message you want to play and then press  (Play).
  - To stop playing the message, press  (Stop).

## Deleting a Message

When the standby screen is displayed, press .

- ➔ Use  to select *Answer Memo* and then press  (Select).
- ➔ Use  to select *Answer Memo List* and then press  (Select).
- ➔ Use  to select the message you want to delete and then press  (SubMenu).
- ➔ Use  to select *Delete* and then press  (OK).
- ➔ Use  to select *Delete One* and then press  (OK).
- ➔ Use  to select *YES* and then press  (OK).

## Global Functions

You can use H001 overseas in the area supporting Global Passport CDMA without any special applications.

### Setting Area

When the standby screen is displayed, press .

➔ Use  to select *Accessories* and then press  (Select).

➔ Use  to select *GLOBAL Function*, press  (Select) and then press  (OK).

➔ Use  to select *Area Setting* and then press  (Select).

➔ Use  to select *Overseas* and then press  (Select).

- Confirmation screen is displayed. Use  to select *YES* and then press  (OK).

### Calling to Japan from Overseas

When the standby screen is displayed, enter a phone number and then press  (SubMenu).

➔ Use  to select *Intl Call:Japan* and then press  (OK).

➔ Press .

- At the time of purchase, the service area information (PRL: Roaming area information) is set. However, this information may be updated several times a year. Update to the latest data before departure.
- When making a call from Japan to a cell phone overseas supporting Global Passport CDMA, make a call in the normal operation.
- Subscribe and make initial settings for EZweb in Japan.

# Character Input

## Character Entry Modes

When a character entry screen is displayed, you can select a character entry mode if you press  (Char.Type).

### Menu Items

 : Kanji conversion mode

 : Double-byte katakana mode



 : Single-byte katakana mode

 : Double-byte alphanumeric mode

 : Single-byte alphanumeric mode

 : Double-byte number mode

 : Single-byte number mode













Use  to select a character entry mode and then press  (OK).

## Entering Alphanumeric Characters

You can use the keys  to  to enter characters.

More than one character is assigned to each key.

The following table shows the key assignment for entering characters.



|   | Number of Times to Press the Key  |                |   |   |   |   |   |   |   |    |    |    |
|---|---|----------------|---|---|---|---|---|---|---|----|----|----|
| Key   | 1   | 2              | 3 | 4 | 5 | 6 | 7 | 8 | 9 | 10 | 11 | 12 |
|  | .   | @              | - | _ | / | : | ~ | 1 |   |    |    |    |
|  | a   | b              | c | A | B | C | 2 |   |   |    |    |    |
|  | d   | e              | f | D | E | F | 3 |   |   |    |    |    |
|  | g   | h              | i | G | H | I | 4 |   |   |    |    |    |
|  | j   | k              | l | J | K | L | 5 |   |   |    |    |    |
|  | m   | n              | o | M | N | O | 6 |   |   |    |    |    |
|  | p   | q              | r | s | P | Q | R | S | 7 |    |    |    |
|  | t   | u              | v | T | U | V | 8 |   |   |    |    |    |
|  | w   | x              | y | z | W | X | Y | Z | 9 |    |    |    |
|  | 0   | Inputs symbols |   |   |   |   |   |   |   |    |    |    |
|  | Inputs symbols (switches an unconfirmed character between uppercase and lowercase). |                |   |   |   |   |   |   |   |    |    |    |
|  | Adds a line break and displays characters in the opposite order.                    |                |   |   |   |   |   |   |   |    |    |    |

When you change your e-mail address, you cannot use the characters in  for the account name (part of the address to the left of @).

## Entering Two or More Characters Assigned to the Same Key

After you enter the first character, press  and then enter the next character.

## Deleting Characters

To delete one character at a time, move the cursor to the character you want to delete and then press . To delete all characters to the right of the cursor, hold down  for at least one second. If there are no characters to the right of the cursor, holding down  will delete all the characters.

## Starting a New Line

Press .

- Certain functions such as c-mail do not support entering new lines.

## Entering E-mail Addresses









### E-mail Address Compatible Characters

- Before you enter an e-mail address, switch to the lowercase alphanumeric (single-byte) mode.
- When changing your e-mail address, you can enter up to 30 single-byte alphanumeric and symbol characters for the account name (part to the left of @). Note the following:
  - Uppercase characters cannot be used.
  - Period (.) or zero (0) cannot be used as the first character.

### How to Enter E-mail Addresses

Example: Entering "taro.23@kddi.co.jp"





#### Enter "taro.23".







- t : Press  once.
- a : Press  once.
- r : Press  three times.
- o : Press  three times.
- . : Press  once.
- 2: Press  once and then .
- 3: Press  once and then .

#### ➔ Enter "@".

- @: Press  twice.





#### ➔ Enter "kddi" and then press (OK).

- k: Press  twice.
- d: Press  once and then .
- d: Press  once.
- i : Press  three times.

- ➔ Press  (SubMenu).
- ➔ Use  to select *Phrase* and then press  (OK).
- ➔ Use  (Category) to select *Internet*.
- ➔ Use  to select *.co.jp* and then press  (Select).  
".co.jp" is entered.

## Entering Pictograms



















When a character entry screen is displayed, press .

- ➔ Use  to select the pictogram you want to enter and then press  (Select).
  - You can enter pictograms consecutively if you press  (Repeat) instead of  (Select).

# Phone Book

## Saving a Phone Book Entry







When the standby screen is displayed, hold down  for at least one second.

- ➔ Use  to select  [Name] and then press  (Select).
- ➔ Enter a name and then press  (OK).  
The  [Reading] for the name is entered automatically.
- ➔ Use  to select  [Phone No.1] and then press  (Select).
- ➔ Enter a phone number and then press  (OK).
  - If the phone number is for a fixed-line phone, enter the phone number starting with the area code.
- ➔ Use  to select a phone number type and then press  (Select).
  - Follow the next step to enter an e-mail address. If you do not want to enter an e-mail address, press  (Reg).
- ➔ Use  to select  [E-mail Address1] and then press  (Select).
- ➔ Enter an e-mail address and then press  (OK).
- ➔ Use  to select an e-mail address type and then press  (Select).
- ➔ Press  (Reg).

- The phone book can store up to 1,000 entries.
- The cell phone automatically saves an entry to the lowest available memory number from 000 to 999.
- You can save three phone numbers and three e-mail addresses for each phone book entry.
- You can also assign a group No., and enter birthday, address, and other information.





## Dialing from the Phone Book

When the standby screen is displayed, press .

- ➔ Use  to select the entry containing the phone number you want to dial and then press  (Detail).
- ➔ Use  to select the phone number and then press  (Select).
- ➔ Use  to select *Voice Call* and then press  (OK).



## Editing Phone Book Entries

When the standby screen is displayed, press .

- ➔ Select an entry and press  (Detail).
- ➔ Press  (Edit).
- ➔ Edit the contents and then press  (Reg).
- ➔ Use  to select *Overwrite* and then press  (OK).

## Saving a Phone Number from the Incoming or Outgoing History

Example: Saving a phone number from the incoming history to the phone book

When the standby screen is displayed, press  and use  to select the phone number you want to save.

➔ Press  (SubMenu).

➔ Use  to select *Reg to Adrs Book* and then press  (OK).

➔ Use  to select *Register New* and then press  (Select).

➔ Use  to select a phone number type and then press  (Select).







- For details on saving a phone book entry, see page 28.

## Pair Function

You can register a maximum of five pair partners you contact often to easily call or send mail.

### Registering a Pair Partner



When the standby screen is displayed, press .

- ➔ Use  to select a blank screen and then press  (Select).
- ➔ Use  to select *YES* and then press  (OK).
- ➔ Use  to select a pair partner, press  (Detail) and then  (Select).
  - When registering a phone book entry with multiple phone numbers and e-mail addresses as pair partner, select the phone number and e-mail address to use with the Pair function.

- When you delete a phone book entry registered in the pair partner, the phone book entry is also deleted from the Pair function.



### Making a Call to a Pair Partner

When the standby screen is displayed, press .

- ➔ Use  to select the person you want to call.
- ➔ Use  to select *Call* and then press  (Select).

### Sending Mail to a Pair Partner

When the standby screen is displayed, press .

- ➔ Use  to select the person you want to send mail.
- ➔ Use  to select *E-mail* or *C-mail* and then press  (Select).
  - To create an e-mail message, see "Creating and Sending E-mail Messages" on page 31. To create a c-mail message, see "Creating and Sending C-mail Messages" on page 34.



## Using E-mail



















To use e-mail, you need to apply for an EZweb subscription. If you did not apply for an EZweb subscription at the time of purchase, contact an au shop or the au Customer Service Center. Also, before use, you need to configure initial settings.

You can send and receive e-mail with other cell phones that support e-mail, and with PCs. In addition to text messages of up to 5,000 double-byte (or 10,000 single-byte) characters, you can also send photos and movies by e-mail.

- The packet communication charge for sending and receiving e-mail applies to the amount of data sent and received.
- You can send an e-mail message to up to 30 different addresses at one time.
- You can send up to 1,000 e-mail messages per day (a message with multiple recipients is counted as more than one message).
- Sending and receiving e-mail messages that include attachment data may take a while.



## Creating and Sending E-mail Messages

When the standby screen is displayed, press .



- ➔ Use  to select *Create New* and then press  (Select).
- ➔ Use  to select *Address* and then press  (Select) twice.
- ➔ Use  to select *Address Book* and then press  (Select).
- ➔ Use  to select a phone book entry and then press  (Detail).
- ➔ Use  to select an address and then press  (Select).
- ➔ Press  (OK).
- ➔ Use  to select *Subject* and then press  (Select).
- ➔ Enter a subject and then press  (OK).
  - You cannot enter single-byte katakana characters or a new line in a subject.
- ➔ Use  to select *Text* and then press  (Select).
- ➔ Enter text and then press  (OK).
  - You cannot enter single-byte katakana characters.
- ➔ Press  ( Send).

## Reading Received E-mail Messages

When you receive an e-mail message, *E-mail* appears on the standby screen.



➔ Use  to select *E-mail* and then press  (Select).

➔ Press  (Select).

- : Indicates a read message.
- : Indicates an unread message.

➔ Use  to select the new message and then press  (Select).

### Reading an E-mail Message from the E-mail Menu



When the standby screen is displayed, press  to display the E-mail menu, use  to select *Inbox* and then press  (Select).

For subsequent operations, see "Reading Received E-mail Messages" above.

## Reading an E-mail Message with an Attached Photo or Movie

Example: Viewing an attached photo

Display the e-mail message that has an attached photo (above).

➔ Use  to select the file name and then press  (Select).

➔ Use  to select the file name and then press  (Receive).

➔ Press  (Play).

- Selecting the file name or pressing  (Receive) may be unnecessary for some files to be displayed, depending on the file size.

## Replying to Received E-mail Messages

When the standby screen is displayed, press .

➔ Use  to select *Inbox* and then press  (Select).

➔ Press  (Select).

➔ Use  to select the message you want to reply to and then press  (Select).

➔ Press  (Reply).

"Re:" is prefixed to the subject, and the text of the message is quoted.

➔ Refer to "Creating and Sending E-mail Messages" (page 31) for subsequent operations.













## Rejecting Spam

Setting mail filters to reject spam is recommended. The サポート設定 (Supportive Settings) helps you to set mail filters easily by answering questions that appear on the screen.

### Setting Mail Filters

Example: Connecting to サポート設定 (Supportive Settings)

When the standby screen is displayed, press .

- ➔ Use  to select *E-mail Setup* and then press  (Select).
- ➔ Use  to select *Mail Filter* and then press  (Select).
- ➔ Use  to select *次へ (Next)* and then press  (Select).
- ➔ Use  to select the input box and then press  (Input).
- ➔ Enter your security code and then press  (OK).
- ➔ Use  to select *送信 (Send)* and then press  (Select).
- ➔ Use  to select an item and then press  (Select).

## カンタン設定 (Simple Settings)

|                                       |   |
|---------------------------------------|---|
| サポート設定<br>(Supportive Settings)       | Set the filter by answering questions<br>This is recommended for users who want to configure settings while confirming conditions.                        |
| フィルターレベル (高)<br>Filter Level (High)   | Shut out all mail from PCs<br>This is recommended for users who only want to send mail to and receive mail from cell phones.                              |
| フィルターレベル (中)<br>Filter Level (Medium) | Block unsolicited advertisement, spoof e-mail and mail from specific addresses<br>This is recommended for users bothered by certain senders or spam mail. |
| フィルターレベル (低)<br>Filter Level (Low)    | Block unsolicited advertisement and spoof e-mail<br>This is the minimum level recommended for all users.  |

- You can also prevent spam by changing your e-mail address. For details on changing your e-mail address, see page 17.

## Using C-mail

C-mail is a service that uses phone numbers as addresses to exchange messages between au cell phones that support c-mail. A c-mail message can contain up to 50 double-byte (or 100 single-byte) characters.

- The c-mail send charge applies when sending c-mail.









### C-mail Safety Block





C-mail safety block is a function that allows you to reject c-mails that include URLs (<http://△△△>, <https://△△△>) or phone numbers in the c-mail message text.

C-mail safety block is valid by default. Cancel the setting if you want to receive c-mails that include URLs and phone numbers in the message text.

## Creating and Sending C-mail Messages







When the standby screen is displayed, hold down  for at least one second.

- ➔ Use  to select *Create New* and then press  (Select).
- ➔ Enter text and then press  (OK).
- ➔ Use  to select  [Address] and then press  (Edit).
- ➔ Use  to select *Quote Adrs Book* and then press  (OK).



- ➔ Use  to select a phone book entry and then press  (Detail).
- ➔ Use  to select a phone number and then press  (Select).
- ➔ Press  (Send).

## Reading Received C-mail Messages

When you receive a c-mail message, *C-mail* appears on the standby screen.

- ➔ Use  to select *C-mail* and then press  (Select).
- ➔ Press  (Select).
  - : Indicates a read message.
  - : Indicates an unread message.
- ➔ Use  to select the new message and then press  (View).

### Reading a C-mail Message from the C-mail Menu

When the standby screen is displayed, hold down  for at least one second to display the C-mail menu, use  to select *Inbox* and then press  (Select).

For subsequent operations, see "Reading Received C-mail Messages" above.

## Camera

Your cell phone has a CMOS camera with 5.00 million effective pixels (Sub camera:0.34 million effective pixels) for shooting photos and movies. You can use the self-timer and autofocus.

Shot images can be used for the standby screen, and attached to e-mail messages.

Press  to switch the sub camera.

## Photo Taking Tips

When taking photos, frame the subject within the display and hold the cell phone steady with both hands to avoid shaking.

### Regular Open Position

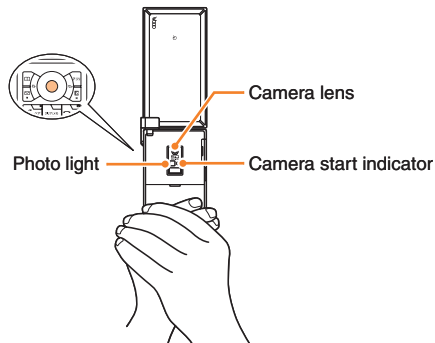

## About Photo Modes

The following modes are available for taking photos. W.paper (Wide) is set for W.paper mode and 5M is set for DSC mode at the time of purchase.





| Mode         | Photo Size       | Storage Location   |
|--------------|------------------|--|
| W.paper Mode | W.paper (Normal) | The <i>Photo Folder</i> in the Data Folder of the cell phone       |
|              | W.paper (Wide)   |  |
| DSC Mode     | 0.3M             | The <i>DSC Folder</i> in the Data Folder of a microSD memory card* |
|              | 1M               |  |
|              | 2M               |  |
|              | 3M               |  |
|              | 4M (Wide)        |  |
| 5M           |                  |  |

\* When a microSD memory card (commercially available) is not inserted, the files are saved to the Data Folder of the cell phone.

- Take care not to cover the lens and optical sensor with a strap or finger.

## Taking a Photo

When the standby screen is displayed, press .

- ➔ Use  to select *Camera* and then press  (Select).
- ➔ Use  to select *Photo (W.paper Mode)* and then press  (Select).
- ➔ Press  (Shoot).  
The preview screen is displayed.









## Saving a Photo

Press  (Save) on the preview screen.

- If you do not want to save the photo, press  in the preview screen.

## Viewing Photos

When the standby screen is displayed, press .

- ➔ Use  to select *Data Folder* and then press  (Select).
- ➔ Use  to select *Photo Folder* and then press  (Select).
- ➔ Use  to select a folder and then press  (Select).
- ➔ Use  to select the photo you want to view and then press  (Select).

EZweb is an information service that allows you to enjoy browsing the Internet on your cell phone. You can also download Chaku-Uta-Full®, Chaku-Uta®, news, and other contents from web pages.

To use EZweb, you need to apply for an EZweb subscription. If you did not apply for an EZweb subscription at the time of purchase, contact an au shop or the au Customer Service Center. Also, before use, you need to configure initial settings.

- The packet communication charge for EZweb connection applies to the amount of data sent and received, not to the length of time connected.
- In addition to communication charges, some sites charge for providing information.

# Accessing Sites

## ■ Viewing the au one Top

You can access EZweb from the au one Top. A variety of useful and fun sites are available on EZweb. When the standby screen is displayed, press **[E]**, use **[↑]** to select *au one Top* and then press **[○]** (Select).



**キーワード検索機能 (Search by Keyword)**  
Provides a search function for searching for information by keyword.

**カテゴリ(メニューリスト) (Category (Menu List))**  
Provides a list of various content provider sites.

**トップニュース (Top News)**  
Provides automatic updates of the latest news.

**最新オススメ情報 (Latest News)**  
Introduces up-to-date information concerning entertainment, daily life, etc.

**天気・乗換・占い・テレビ・銀行 (Weather, Transportation, Horoscope, TV & Bank)**  
Provides direct access to these au one services.

**買う (Shopping & Auctions)**  
Provides a list of shopping and auction sites available from your cell phone.

**知る (Tips & Tools)**  
Provides information on sports and stock prices, as well as useful tools such as maps and dictionaries.

**楽しむ (Hobbies & Culture)**  
Provides the latest information, such as games, music, books, hobbies and entertainment.

**暮らす (Lifestyle)**  
Provides travel, restaurant and other lifestyle-oriented information.

**集まる (Community)**  
Provides interesting and useful information that you can use for SNS or blogs.

**メール (Mail)**  
Provides an extra e-mail address that can be used on your PC.

**マイページ (My Page)**  
Provides useful information and tools tailored to your cell phone usage and a large data storage area.

**au style**  
Introduces information and sites that au recommends.

**とくする情報 (Valuable Information)**  
Presents gifts and push information to the EZweb subscriber for free.

**auお客さまサポート (au Customer Support)**  
Provides information about charges, various applications, au online manual and notices from au.

**auワンちゃんの部屋 (au Doggy's Room)**  
Introduces au Doggy.



**カンタンアクセス・オープンサイト (Simple Access & Open Site)**  
Provides easy access and introduces open sites.



**災害用伝言板 (Disaster Message Board)**  
Register and confirm safety information in time of disaster.

**ENGLISH**  
Introduces English sites.









## Basic Operations

Use  to select the site you want to access and then press  (OK).



Press  or  to return to the previous screen. Hold down either key for at least one second to return to the au one Top.

The following describes the basic operations that are available while accessing sites.

| Key Operation   | Description  |
|---|--|
|    | Exits EZweb.   |
|    | Moves the cursor up and down.<br>When there is data available above or below the current screen, scrolls up and down the screen one line at a time.  |
|    | When there is data available above or below the current screen, scrolls the screen page by page.<br> : Scrolls one page up.<br> : Scrolls one page down. |
|  、  | Returns to the previous screen.  |

## Bookmarking Frequently Accessed Pages

When the page you want to bookmark is displayed, press  (BrowserMenu).

→ Use  to select *New bookmark* and then press  (OK).

- Some pages cannot be bookmarked.

→ Press  (Reg).



The displayed page is bookmarked, and its title and URL are added to the Bookmark.

- The Bookmark can contain up to 100 titles and URLs.

## Viewing Bookmarked Pages









When the standby screen is displayed, press  and then use  to select *EZweb*.

→ Use  to select *Bookmark(s)* and then press  (Select).

→ Use  to select the bookmark for the page you want to view and then press  (Connect).  
The cell phone connects to the site.







## Checking Charges

When the standby screen is displayed, press .

- ➔ Use  to select *Function* and then press  (Select).
- ➔ Use  to select *Time/Toll/Sub* and then press  (Select).
- ➔ Use  to select *Inquire Toll* and then press  (Select).
- ➔ Use  to select *YES* and then press  (OK).
  - Select the item you want to check and then follow the on-screen instructions.

## Downloading Chaku-Uta-Full®/ Chaku-Uta®

When the standby screen is displayed, press  and then use  to select *EZweb*.

- ➔ Use  to select *au one Top* and then press  (Select).
- ➔ Use  to select *カテゴリ (メニューリスト)* (Category (Menu List)) and then press  (OK).
- ➔ Use  to select *着うた (Chaku-Uta®) or 着うたフル・ビデオクリップ (Chaku-Uta-Full®・Video Clip)* and then press  (Select).

- ➔ Use  to select the site you want to access and then press  (Select).

The download instructions appear.

- Fee-based information sites require entry of EZ password or Premium EZ password. Follow the on-screen instructions to enter either password. See page 18 for details.

- ➔ Follow the on-screen instructions.

Download is completed.

- Downloaded data is saved automatically to the Data Folder.

- ➔ Press  (Play).

The downloaded Chaku-Uta-Full® or Chaku-Uta® plays.

- This procedure is only an example for the purpose of explanation and may differ from actual procedures. Follow the instructions on the site from which you want to download the data.

## EZ News Flash/au one Gadget EZweb Subscription Required

Use the EZ News Flash/au one Gadget to display flash news, or activate the set gadget on the standby screen. You can check the news details and other information by selecting the ticker field.

You can use the EZ News Flash and au one Gadget by making a few simple settings following the EZweb initial setup.

### Basic Operations

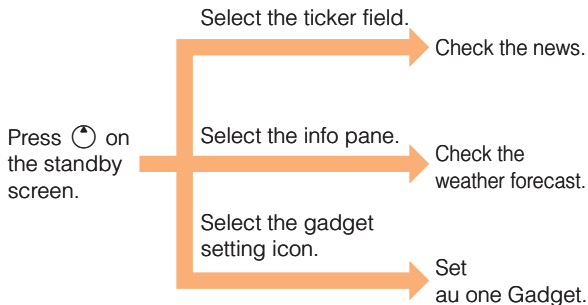

- The EZ News Flash information is automatically received at no charge. Note, however, that packet communication charges may be incurred for manual updates and connecting to EZweb sites. In this case, a confirmation screen for network connection is displayed.

- Packet communication charges are incurred for using au one Gadget applications that require network connection for information updates.
- The EZ News Flash information is updated at regular time intervals.  appears while receiving information.

### Setting EZ News Flash

The EZ News Flash is available free of charge. You have only to make a few simple settings. After following the procedure in “Initial Setup of E-mail and EZweb” on page 12, configure EZ News Flash settings. If you did not configure the EZ News Flash settings at the time of the initial setup, follow the steps below.

**When the standby screen is displayed, select the ticker field and then press  (OK).**

➔ **Follow the on-screen instructions.**

The setup procedure is completed.

- When the standby screen returns, a message asking you to wait for a while until the next update takes place appears in the ticker field.

## ■ Canceling EZ News Flash

When the standby screen is displayed, select the ticker field and then press **⊙** (News).

➔ Press **Ⓜ** (メニュー[Menu]), use **⬇** to select **サービス設定解除 (Service Cancellation)** and then press **⊙** (選択[Select]).

➔ Follow the on-screen instructions.

## ■ Changing the Reception Settings for EZ News Flash Information

You can change the ring tone, vibrator and LED settings under M216 *NewsFlash Receive* for reception of EZ News Flash information.

If you do not want the ring tone to sound when receiving EZ News Flash information, set the volume to *OFF*.

- You can configure the au one Gadget settings from the gadget setting icon on the standby screen.

Using GPS (Global Positioning System), EZ Navi provides useful positional information services.

**When the standby screen is displayed, press  and then use  to select the EZnavi.**

- The packet communication charges for using EZ Navi services apply to the amount of data sent and received. Some services may require a separate information fee.
- Before using EZ Navi, you must configure initial settings of EZweb (page 12).

## Passenger Seat Navi for People in the Passenger Seat to Check the Route

Passenger Seat Navi guides the passengers to the destination with the best route using voice and map.

Drivers are not allowed to use Passenger Seat Navi.

## Security Navi to Check Where Your Kids Are

The Security Navi application is made up of the following three functions:

いつでも位置確認 (Auto Position Search [monthly charge]),  
エリア通知 (Area Message [no monthly charge]),  
位置確認メール (Position Search Mail [no monthly charge])

Using these functions, you can check the position of an au cell phone that supports Security Navi; and automatically send a mail notification to the specified au cell phones when you enter (or are in) or leave (or are no longer in) the set area within a predetermined period of time.

# EZ Navi Walk for When You Go Out

## ■ フルモード (Full mode)



| Function  | Explanation  |
|---|--|
| トータルナビ/地図<br>(Total Navigation/Map)                           | Navigate optimum route from various transportation means such as train/aircraft/bus/taxi. See current position and map of wherever you like. |
| 乗換/時刻表(Connection/Timetable)                                  | Search for train connections, timetables and railway information.  |
| お店/施設/イベント<br>(Shop/Facility/Event)                           | Search for shops, facilities and event information.  |
| ドライブ/渋滞情報<br>(Road/Traffic Information)                       | See road and traffic information nationwide in real time.  |
| オススメ便利メニュー<br>(Useful Menu)                                   | Provides PC cooperative service and functions enabling you to enjoy EZ Navi Walk more.   |
| 設定/会員登録/インフォ<br>(Setting/Membership Registration/Information) | Configure settings/membership registration/campaign information.   |

## ■ シンプルモード (Simple mode)



| Function   | Explanation   |
|--|---|
| ナビをする(Navigation)                                  | Navigate optimum route from various transportation means such as train/aircraft/bus/taxi. |
| 現在地の地図<br>(Map of Your Current Location)           | See map around of your current location.  |
| 乗換案内(Connection Information)                       | Confirm train connections from the departure to the arrival station.                      |
| 渋滞/交通情報<br>(Traffic/Transit Information)           | See road and traffic information nationwide in real time.                                 |
| 会員登録・インフォ<br>(Membership Registration/Information) | Configure settings/membership registration/campaign information.                          |
| フルモードとは(About Full Mode)                           | Introduces functions available in Full mode.  |

## 3D Navi

Shows a 3D view at guidance points and around the destination area.

## Evacuate Navi to Guide You Home or to Nearby Evacuation Areas during Disasters

Nearby public evacuation areas or the direction to your home can be determined using the map data pre-installed on the H001 (避難所マップ[Evacuate Area Map] ).

Other useful contents can be downloaded from the 災害時ナビ(Evacuate Navi) section of the EZweb site, including 帰宅支援マップ(Route Home Map) which can guide you between two locations you specify, for example, from your office to home.

- Some contents require a monthly charge.
- Use the information on the screen as a reference and always follow the instructions of police, fire and other municipal authorities.
- When using Evacuate Navi, checking your current position may take more time than usual depending on the status of the GPS satellites.

## TV (1Seg)

EZweb Subscription Required

"1Seg", a mobile terrestrial digital television service in Japan, is available on the H001.

### Using the TV Antenna

When watching TV (1Seg), fully extend the TV antenna to ensure good reception.

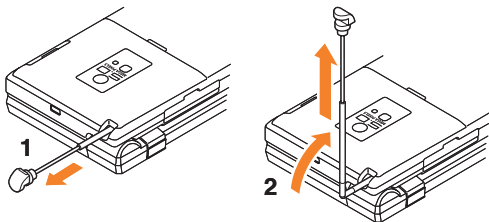

- Before using TV, you must configure initial settings of EZweb (page 12).
- If you are watching TV indoors, you may be able to improve the reception by moving closer to a window.

- The continuous viewing times of TV (1Seg) are as follows. The figures vary according to the usage of data broadcasts.

|                         |                   |   |
|-------------------------|-------------------|---|
| Continuous viewing time | Using earphones   | DBEX ON:<br>Approx. 2 hrs 50 min.<br>DBEX OFF:<br>Approx. 2 hrs 50 min. |
|                         | Using the speaker | DBEX ON:<br>Approx. 2 hrs 50 min.<br>DBEX OFF:<br>Approx. 2 hrs 50 min. |

- For information about the "1Seg" service, refer to the following homepage.

The Association for Promotion of Digital Broadcasting

|                   |   |
|-------------------|---|
| From a PC         | <a href="http://www.dpa.or.jp/">http://www.dpa.or.jp/</a>               |
| From a cell phone | <a href="http://www.dpa.or.jp/1seg/k/">http://www.dpa.or.jp/1seg/k/</a> |



## Initial Setup of au Media Tuner

To watch TV (1Seg) using the au Media Tuner, you need to configure initial settings.



**When the standby screen is displayed, hold down  for at least one second.**

Disclaimer notes are displayed.

➔ Use  to check the disclaimer notes, use  to select **OK**, and then press  (選択 [Select]).

The initial setting screen for using the au Media Tuner is displayed.

- Follow the on-screen instructions to configure each setting. Then, the screen for setting TV (1Seg) channels appears.

➔ Use  to select **オート設定 (放送波) (Auto (Broadcasting wave))** and then press  (選択 [Select]).

Automatic channel scanning begins. When receivable channels are found, the channel setup is completed.

- Select **マニュアル設定 (Manual)** to set the channel manually.

## Watching TV (1Seg)

**When the standby screen is displayed, hold down  for at least one second.**

### ■ To Change Channels

Use /   to change channels.

You can select TV (1Seg) and EZ Channel-Plus/EZ Channel programs.

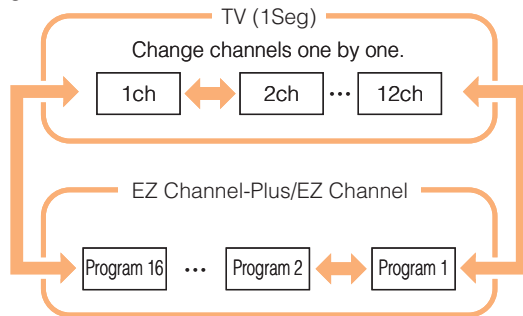

- Before using this feature, you must configure au Media Tuner initial settings (see the procedure on the left).
- Channels cannot be changed with  when the data operation screen is displayed.

## Basic Operations

Launch TV (1Seg) to start receiving data broadcasts.

The data operation screen appears when a data broadcast is received. Press  (Vol/Ch) on the data operation screen to switch to the TV operation screen.

On the TV operation screen, pressing  switches the display.

Data operation screen



 (Vol/Ch)

TV operation screen





 (戻る[Return])

- On the TV operation screen, use  to adjust the volume.

## Viewing in Wide Open Position

After making initial settings for au Media Tuner, you can enjoy it in Wide open position. Refer to "Position of H001" (page 8) and set your cell phone in Wide open position before moving to the next step.



When the **Wide open** menu is displayed, use  to select **TV (1Seg)** and then press .

→ Use  to adjust the volume.



## Wide Open Start

When *Wide Open Start* is set to *TV (1Seg)*, you can start Television (1Seg) just by opening your cell phone in Wide open position when the standby screen is displayed.

**When the standby screen is displayed, open your cell phone in Wide open position.**

Television (1Seg) starts.

## Exiting the au Media Tuner

Press , use  to select **はい** (YES) and then press .

## In Case of Loss of Your H001

The Remote Ctrl Lock allows you to remotely activate the Auto Lock, FeliCa Lock, and Address Book Lock, preventing others from using your cell phone.

### Setting Conditions for Activating the Remote Ctrl Lock

You can activate the Remote Ctrl Lock by calling your H001 a set number of times from a registered phone number within a specified period of time.

When the standby screen is displayed, press **⊙**.

- ➔ Use **⊕** to select *Function* and then press **⊙** (Select).
- ➔ Use **⬇** to select *Privacy/Rstr* and then press **⊙** (Select).
- ➔ Use **⬇** to select *Security Lock* and then press **⊙** (Select).
- ➔ Use **⬇** to select *Rem. Ctrl Lock* and then press **⊙** (Select).
- ➔ Enter Lock No., and then press **⊙** (OK).
- ➔ Use **⬇** to select *Valid No.* and then press **⊙** (Select).
- ➔ Use **⬇** to select *[Register New]* and then press **⊙** (Select).

- ➔ Use **⬇** to select *Direct Input*, press **⊙** (OK), enter a phone number, and then press **⊙** (OK).
- ➔ Press **☎** (Comp).
- ➔ Use **⬇** to select *Duration (min)* and then press **⊙** (Select).
- ➔ Enter a time and then press **⊙** (Set).
  - This sets the time limit for receiving the set number of calls after the first call is received.
  - You can set a time from one to ten minutes.
- ➔ Use **⬇** to select *No. of Incm*, and then press **⊙** (Select).
- ➔ Enter a number of calls, and then press **⊙** (Set).
  - This sets the number of calls to receive to activate the Remote Ctrl Lock.
  - You can set a number of calls from three to ten.
- ➔ Press **☎** (Save).
- ➔ Use **⬇** to select *YES* and then press **⊙** (OK).

### Remotely Activating the Remote Ctrl Lock on Your H001

Call the H001 from the registered phone number repeatedly within the set time limit.

- When the specified number of calls are received, the Remote Ctrl Lock is activated and a message plays telling you that the cell phone is locked.

## Activating the Remote Ctrl Lock by the Security Lock Service

Even if the Remote Ctrl Lock is not set in advance, the Remote Ctrl Lock can be activated by calling au Customer Service Center or completing the application process on au Customer Support from a PC.

The Security Lock Service is available free of charge.

### Calling au Customer Service Center to Activate/Cancel the Remote Ctrl Lock

From an au cell phone: 113 without a prefix (toll free)

From any other cell phone or fixed-line phone:

 0077-7-113 (toll free)

Open 24 hours

Follow the voice guidance to complete the application process.











### Activate/Cancel the Remote Ctrl Lock from a PC





Login to au Customer Support (<http://cs.kddi.com/>) and complete the application process by following the on-screen instructions.

- You must fill out an application to use au Customer Support (the application can be filled out even after your cell phone is lost).

- The Remote Ctrl Lock cannot be activated when the H001 is turned off or out of the service area, or Emission OFF is set to *ON*.

# Troubleshooting

| Symptom                                    | Possible Cause  | Remedy   | Page |
|--|---|--|------|
| Cannot turn on power.                      | ● Is the battery pack charged?  | Charge the battery pack.   | 10   |
|  | ● Did you hold down  for at least a few seconds? | Hold down  for at least a few seconds.   | 12   |
| Cannot make calls.                         | ● Is power turned on?   | Hold down  for at least a few seconds.   | 12   |
|  | ● Is  (out of range indicator) displayed?        | Move to a location where  (out of range indicator) is no longer displayed, and try again. | 12   |
|  | ● Is your hand or a metal object covering the area around the built-in antenna?   | Make sure your hand or any other metal object is not covering the area around the built-in antenna.  | 7    |
|  | ● Did you enter the phone number starting with the area code?   | When making a call to a phone other than a cell phone, you need to enter the area code even if you are inside the same area.   | 19   |
| Cannot receive calls.                      | ● Is  (out of range indicator) displayed?        | Move to a location where  (out of range indicator) is no longer displayed.                | 12   |
|  | ● Is power turned on?   | Hold down  for at least a few seconds.   | 12   |
| No response when a key is pressed.         | ● Is power turned on?   | Hold down  for at least a few seconds.   | 12   |
| A warning tone sounds and power turns off. | ● Is there enough power left in the battery pack?   | Charge the battery pack.   | 10   |
| Calls are answered automatically.          | ● Is Answer memo turned on?   | Hold down  for at least one second to turn off Answer memo.                                | 23   |

| Symptom  | Possible Cause   | Remedy  | Page |
|--|--|---|------|
| Cannot hear the other party.   | ● Is the earpiece volume too low?  | Press  during a call to increase the earpiece volume.                         | 21   |
| When making a call, a beeping sound is heard from the earpiece and a connection cannot be established. | ● Is  (out of range indicator) displayed?<br>Or are you in a location where the signal is too weak? | Move to a location where  (out of range indicator) is no longer displayed. | 12   |
|  | ● Is the wireless line busy or is the phone you are calling on another line?   | End the call and try again later.   | 19   |
| The LED display flashes but the ring tone does not play.   | ● Is manner mode turned on?  | Hold down  for at least one second to turn off manner mode.                 | 21   |
|  | ● Is  (ring tone off indicator) displayed?  | Increase the volume of the incoming call ring tone.   | 22   |
| Cannot charge the battery pack.  | ● Are the plug and connector of the common AC adapter 01/02 (sold separately) inserted properly?   | Insert the plug and connector firmly.   | 10   |
|  | ● Is the battery pack installed correctly?   | Correctly install the battery pack.   |      |
| When the camera is activated, no subject is displayed.   | ● Is a finger or other object covering the camera lens?  | Check the position of the camera lens and remove the obstacle.  | 35   |

- For more detailed information, visit the following au troubleshooting sites:
  - From an au cell phone:  ⇒ *au one Top* ⇒ *auお客様サポート* (au Customer Support) ⇒ *オンラインマニュアル* (Online Manual) ⇒ *故障診断Q&A* (Troubleshooting FAQ)
  - From a PC: <http://www.kddi.com/customer/service/au/trouble/kosho/index.html>

# Index

## Numeric

|            |    |
|------------|----|
| 1Seg ..... | 46 |
| 3D .....   | 9  |

## A

|                           |    |
|---------------------------|----|
| Accessories .....         | 6  |
| Alert window .....        | 12 |
| Answer memo .....         | 23 |
| Playback .....            | 23 |
| Turning off .....         | 23 |
| Turning on .....          | 23 |
| au one Gadget .....       | 41 |
| Gadget setting icon ..... | 41 |

## B

|                          |      |
|--------------------------|------|
| Battery level .....      | 13   |
| Battery pack .....       | 6,10 |
| Battery pack/cover ..... | 7    |

## C

|                             |    |
|-----------------------------|----|
| Camera .....                | 35 |
| Photo taking tips .....     | 35 |
| Taking a photo .....        | 36 |
| Cell phone etiquette .....  | 2  |
| Character input .....       | 25 |
| Character entry modes ..... | 25 |
| Deleting characters .....   | 26 |

|   |    |
|---|----|
| Entering characters from the same key ..... | 26 |
| Starting a new line .....                   | 26 |
| Charging the battery pack .....             | 10 |
| Checking charges .....                      | 40 |
| C-mail .....                                | 34 |
| C-mail safety block .....                   | 34 |
| Creating and sending .....                  | 34 |
| Reading received mail .....                 | 34 |
| Contents .....                              | 4  |

## D

|                                      |      |
|--------------------------------------|------|
| Disaster Message Board Service ..... | 3    |
| Display .....                        | 7,13 |
| Domain .....                         | 17   |
| Downloading Chaku-Uta® .....         | 40   |
| Downloading Chaku-Uta-Full® .....    | 40   |

## E

|                               |    |
|-------------------------------|----|
| Earpiece volume .....         | 21 |
| E-mail .....                  | 31 |
| Creating and sending .....    | 31 |
| Initial settings .....        | 12 |
| Reading .....                 | 32 |
| Received mail .....           | 32 |
| Replying .....                | 32 |
| Viewing attached images ..... | 32 |
| E-mail address .....          | 12 |
| Available characters .....    | 25 |
| Changing .....                | 17 |
| Entering .....                | 26 |

|                                       |    |
|---------------------------------------|----|
| Entering pictograms .....             | 27 |
| Evacuate Navi .....                   | 45 |
| EZ Navi .....                         | 43 |
| EZ Navi Walk .....                    | 44 |
| EZ News Flash .....                   | 41 |
| Canceling .....                       | 42 |
| Changing the Reception Settings ..... | 42 |
| Info pane .....                       | 41 |
| Setting .....                         | 41 |
| Ticker field .....                    | 41 |
| EZ password .....                     | 18 |
| EZweb .....                           | 37 |
| Accessing sites .....                 | 38 |
| au one Top .....                      | 38 |
| Basic operations .....                | 39 |
| Initial settings .....                | 12 |

## G

|                        |    |
|------------------------|----|
| Global Functions ..... | 24 |
| Setting Area .....     | 24 |

## I

|                          |       |
|--------------------------|-------|
| Incoming history .....   | 21    |
| Indicators .....         | 13    |
| Initial settings .....   | 12,47 |
| au Media Tuner .....     | 47    |
| E-mail · EZweb .....     | 12    |
| TV (1Seg) .....          | 47    |
| International Call ..... | 19    |
| Internet .....           | 37    |
| Sites .....              | 38,39 |

## K

|                       |    |
|-----------------------|----|
| Key assignments ..... | 11 |
|-----------------------|----|

## L

|                           |    |
|---------------------------|----|
| Language .....            | 12 |
| Learning the basics ..... | 11 |
| LED display .....         | 14 |
| Lock No. ....             | 18 |

## M

|                       |    |
|-----------------------|----|
| Mail .....            | 31 |
| C-mail .....          | 34 |
| E-mail .....          | 31 |
| Mail filters .....    | 33 |
| Simple settings ..... | 33 |
| Main menu .....       | 14 |
| Manner mode .....     | 21 |

## N

|                      |   |
|----------------------|---|
| Names of parts ..... | 7 |
|----------------------|---|

## O

|                        |    |
|------------------------|----|
| One-ring calls .....   | 21 |
| Outgoing history ..... | 21 |

## P

|                                       |    |
|---------------------------------------|----|
| Pair Function .....                   | 30 |
| Making a call to a pair partner ..... | 30 |



|   |    |
|---|----|
| Registering a pair partner .....                                  | 30 |
| Sending mail to a pair partner .....                              | 30 |
| Passenger Seat Navi .....   | 43 |
| Passwords .....   | 18 |
| Phone (call) .....  | 19 |
| 184/186 .....   | 19 |
| Answering .....   | 20 |
| International Call .....  | 19 |
| Making .....  | 19 |
| Returning .....   | 21 |
| Phone book .....  | 28 |
| Dialing .....   | 28 |
| Editing .....   | 28 |
| Saving .....  | 28 |
| Saving a phone number from the incoming or outgoing history ..... | 29 |
| Phone number .....  | 12 |
| Photos .....  | 35 |
| Photo modes .....   | 35 |
| Taking .....  | 36 |
| Viewing .....   | 36 |
| Playback  |    |
| Answer memo .....   | 23 |
| Position of H001 .....  | 8  |
| Premium EZ password .....   | 18 |

## R

---

|                           |    |
|---------------------------|----|
| Remote Ctrl Lock .....    | 49 |
| Ring tones                |    |
| Changing the type .....   | 22 |
| Changing the volume ..... | 22 |

## S

---

|                              |    |
|------------------------------|----|
| Security code .....          | 18 |
| Security Lock Service .....  | 50 |
| Security Navi .....          | 43 |
| Signal strength .....        | 13 |
| Simple menu .....            | 15 |
| Sites .....                  | 38 |
| Bookmarking .....            | 39 |
| Viewing from bookmarks ..... | 39 |
| Spam .....                   | 33 |

## T

---

|                            |    |
|----------------------------|----|
| Troubleshooting .....      | 51 |
| Turning on/off power ..... | 12 |
| TV (1Seg) .....            | 46 |
| Antenna .....              | 46 |
| Basic operations .....     | 48 |
| Changing channels .....    | 47 |
| Exiting .....              | 48 |
| Initial settings .....     | 47 |

## V

---

|              |    |
|--------------|----|
| Viewing      |    |
| Photos ..... | 36 |

## W

---

|                      |    |
|----------------------|----|
| Wide open menu ..... | 16 |
|----------------------|----|

For inquiries, call: au Customer Service Center

For general information and charges (toll free)

From fixed-line phones:

 0077-7-111

From au cell phones:

157 area code not required

PRESSING ZERO WILL CONNECT YOU TO AN OPERATOR  
AFTER CALLING 157 ON YOUR au CELL PHONE

For loss, theft or damage and operation information  
(toll free)

From fixed-line phones:

 0077-7-113

From au cell phones:

113 area code not required

From EZweb:

Access Method

 au one Top ▶ auお客様サポート (au Customer Support)  
▶ お問い合わせ (Inquiries)  
▶ Menu are subject to change without prior notice.

なるほど! au  
みんなで作る、auQ&Aサイト

Access Method

 au one Top ▶ auお客様サポート (au Customer Support)  
▶ みんなでQ&A「なるほど! au」(au User's Forum)

Read this code for an easy  
access to みんなでQ&A「なる  
ほど! au」(au User's Forum).

▶ The packet communication  
charge applies.



モバイル・サイタルネットワーク  
環境への配慮が大切です。

Cell phone and PHS operators collect and recycle unused  
telephones, batteries and battery chargers at stores  
bearing the ♻️ logo regardless of brand and manufacturer  
to protect the environment and reuse valuable resources.

Read this code for  
an easy access to  
au Online Manual.



BMN6460YAA-1  
January 2009, 1st Edition

Sales: KDDI CORPORATION ·  
OKINAWA CELLULAR TELEPHONE COMPANY  
Manufactured by: Hitachi, Ltd.