

au by KDDI

BRAVIA® Phone

S004

Basic Manual

READ THIS MANUAL TO MASTER
THE CELLULAR PHONE

www.au.kddi.com

Illustrations and
Screenshots
in This Manual

Notes on
Cell Phone Use

Contents

Getting Ready

Making and
Answering Calls

Global Function

Character Input

Phone Book

Mail

Camera

EZweb

EZ News EX

EZ Navi

TV (1Seg)

In Case of
Loss of Your S004

Troubleshooting

Index

Introduction

Thank you for purchasing the S004. Before using your S004, be sure to read the S004 Basic Manual (this PDF manual) to ensure correct usage. After you have finished reading this manual, store this PDF manual and the printed manuals in safe places so you can retrieve them whenever you need them.

Manuals for the S004

There are three manuals for the S004: the Basic Manual, printed Instruction Manual (Japanese) and full Instruction Manual (Japanese).

● For learning the basics:

Read the S004 Basic Manual (this manual) or printed S004 Instruction Manual (Japanese).

● For learning details of each function:

The full Instruction Manual (Japanese) gives detailed instructions on using each function and can be downloaded from the au homepage: <http://www.au.kddi.com/torisetsu/index.html>

To ensure proper usage of the S004, be sure to read the Safety Precautions "安全上のご注意" in the Instruction Manual.

- To access from EZweb (free of packet communication charge):  ⇒ *Top Menu/Search* ⇒ *auお客様サポート* (au Customer Support) ⇒ *オンラインマニュアル* (Online Manual)

Scan this QR code to access the au Online Manual. ▶



- All mentions of "the S004" in this manual refer to "BRAVIA® Phone S004."

Illustrations and Screenshots in This Manual

Note on Illustrations

The illustrations in this manual may look different from the actual cell phone in shape, color and typeface. The key illustrations are also simplified as shown below.

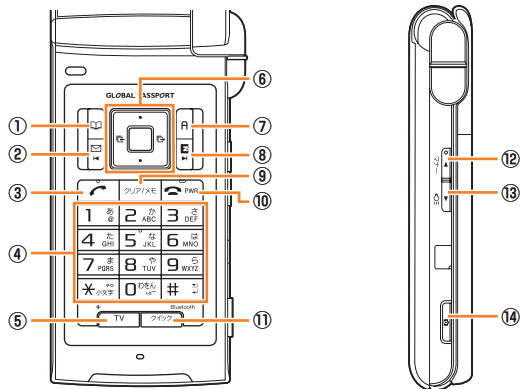

	Key Illustration		Key Illustration
①		⑧	
②		⑨	
③		⑩	
④		⑪	
⑤		⑫	
⑥		⑬	
⑦		⑭	

Note on Screenshots

The screenshots in this manual are simplified and may look different from the actual cell phone screens.

Notes on Cell Phone Use

Cell Phone Etiquette

The cell phone always emits weak radio waves when power is on.

Use the cell phone in an enjoyable and safe manner without forgetting to be considerate of others around you.

- **Use of cell phones is not allowed in some places.**
 - Do not use the cell phone while you are driving. Doing so is both dangerous and prohibited by law.
 - Using a cell phone in an aircraft is prohibited by law. Set Airplane Mode to *ON* and turn the cell phone power off.
- **Radio waves from cell phones may interfere with medical electrical equipment.**
 - Some people close to you in crowded places such as packed trains may be using a cardiac pacemaker. Turn the cell phone off in such places.
 - Abide by the rules of hospitals and other medical institutions where it is forbidden to use or carry cell phones.
- **Be considerate of where you use the cell phone and how loudly you talk.**
 - Do not make calls in theaters, museums, libraries, and other similar places. Turn power off or turn on manner mode not to disturb others around you by ring tones.
 - Do not use the cell phone on a street where you might interrupt the flow of pedestrians.
 - Move to areas where you will not inconvenience others on trains or in hotel lobbies.
 - Refrain from talking in a loud voice.

- Obtain the permission of other people before you take their photos with the cell phone's camera.
- Do not record information with the cell phone's camera in bookstores and other locations where taking photos is not permitted.

Do Not Use the Cell Phone While Driving!

Turn off your cell phone or put it in Drive Mode while driving.



Do not use the cell phone while driving a car/motorcycle or riding a bicycle. It may result in a traffic accident. Using a cell phone while driving is prohibited by law. Using a cell phone while riding a bicycle may also be punishable by law.

Prohibited!

- Looking at a cell phone display
- Talking on a cell phone while holding it

Drive Mode

In Drive Mode, a Japanese message meaning "I am driving right now. Please leave your name and message after the beep." is played when a call is received, and asks the caller to leave a message on the answer memo.

When the standby screen is displayed, press , use  to select *Drive*, and then press  (Set).

Disaster Message Board Service

When a large scale disaster occurs, you can register your safety information from EZweb. The registered information can be referred from anywhere in Japan from EZweb or Internet.

Registering safety information

- When a large scale disaster occurs, from an au phone, you can register your safety information (i.e. your condition and comments) to the 災害用伝言板 (Disaster Message Board) created on the EZweb.
- After registration of your safety information, e-mail is sent to your family or acquaintances you have previously designated to notify that your safety information has been uploaded to the 災害用伝言板 (Disaster Message Board).

Inquiring for safety information

- You can inquire for safety information of a person by entering his/her phone number from EZweb or Internet.*
* To inquire from other carriers' cell phone, a PHS or PC, access "<http://dengon.ezweb.ne.jp/>".

Access	 ⇒ Top Menu/Search ⇒ 災害用伝言板 (Disaster Message Board)
	http://dengon.ezweb.ne.jp/

- Registered information is stored until the service set up for the disaster ends.
- The maximum available number of registrations is 10 per phone number. When the number of registrations exceeds 10, the oldest one is overwritten.
- The demonstration of this service can be referred to anytime by pressing  ⇒ Top Menu/Search ⇒ auお客様サポート (au Customer Support) ⇒ 調べる (Search) ⇒ 災害用伝言板 (デモ版) (Disaster Message Board (Demo Version)).
- To view the Disaster Message Board in English, select *English* from the top menu of the Disaster Message Board.

Contents

Introduction

Illustrations and Screenshots in This Manual 1

Notes on Cell Phone Use 2

Cell Phone Etiquette.....	2
Do Not Use the Cell Phone While Driving!.....	2
Disaster Message Board Service.....	3

Contents 4

Getting Ready 6

Checking the Contents of the Box.....	6
Names of Parts.....	7
Charging the Battery Pack.....	8
Learning the Basics.....	9
Turning On Power.....	10
Switching the Display Language to English.....	10
Initial Setup of E-mail and EZweb.....	10
Checking Your Phone Number and E-mail Address ...	10
Display Indicators.....	11
Using Main Menu.....	13
Changing Your E-mail Address.....	14
Security Code and Passwords.....	15

Making and Answering Calls 16

Making a Call.....	16
Making an International Call.....	16
Answering a Call.....	17

Returning a Call (Outgoing History/Incoming History).....	17
One-ring Calls.....	17
Adjusting the Earpiece Volume during a Call.....	18
Turning On Manner Mode.....	18
Changing the Incoming Ring Tone.....	18
Adjusting the Incoming Ring Tone Volume.....	19
Turning On the Answer Memo.....	19

Global Function 21

Setting the Area.....	21
Obtaining the Latest PRL (Preferred Roaming List) ...	21
Calling Japan from Overseas.....	22

Character Input 23

Character Entry Modes.....	23
Entering Alphanumeric Characters.....	23
Entering E-mail Addresses.....	24
Entering Pictograms/Symbols/Face marks.....	25

Phone Book 26

Saving a Phone Book Entry.....	26
Dialing from the Phone Book.....	26
Editing Phone Book Entries.....	26
Saving a Phone Number from the Incoming or Outgoing History.....	27

Mail 28

Using E-mail.....	28
Creating and Sending E-mail Messages.....	28
Reading Received E-mail Messages.....	29

Reading an E-mail Message with an Attached Photo or Movie.....	29	Evacuate Navi to Guide You Home or to Nearby Evacuation Areas during Disasters	42
Replying to Received E-mail Messages.....	29	TV (1Seg)	43
Rejecting Spam.....	30	Initial Setup of au Media Tuner	44
Using C-mail.....	31	Watching TV (1Seg)	44
Creating and Sending C-mail Messages.....	31	Basic Operations.....	45
Reading Received C-mail Messages	31	Exiting the au Media Tuner	45
Camera	32	In Case of Loss of Your S004	46
Photo Taking Tips	32	Setting Conditions for Activating the Remote Ctrl Lock	46
About Photo Modes.....	32	Remotely Activating the Remote Ctrl Lock on Your S004.....	47
Taking a Photo.....	33	Activating the Remote Ctrl Lock by the Security Lock Service	47
Viewing Photos.....	33	Troubleshooting	48
EZweb	34	Index	50
Accessing Sites.....	35	Radio Wave Exposure and Specific Absorption Rate (SAR) Information	53
Bookmarking Frequently Accessed Pages.....	36	Radio Frequency (RF) exposure and Specific Absorption Rate (SAR).....	54
Viewing Bookmarked Pages.....	36	Guidelines for Safe and Efficient Use.....	55
Checking Charges.....	37	FCC Statement for the USA	58
Downloading Chaku-Uta-Full®/Chaku-Uta®.....	37	Industry Canada Statement	59
EZ News EX	38	Declaration of Conformity for CDMA SO004.....	60
Basic Operations	38		
Setting EZ News EX.....	38		
EZ Navi	40		
Passenger Seat Navi for People in the Passenger Seat to Check the Route	40		
Security Navi to Check Where Your Kids Are	40		
EZ Navi Walk for When You Go Out	41		

Getting Ready

Checking the Contents of the Box

The box contains the cell phone and accessories.

- Cell phone
- Battery pack

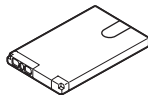
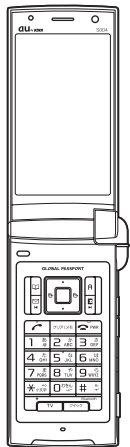

- Instruction Manual (Japanese)
- Warranty (Japanese)
- Safety Precautions (Japanese)
- Global Passport CDMA/GSM Owner's Guide (Japanese)
- Osafu-Keitai® Guide (Japanese)
- JIBUN BANK Launcher Operation Guide (Japanese)
- Wi-Fi WIN Operation Guide (Japanese)

- An AC adapter and microSD™ memory card are not included. Purchase a specified AC adapter (sold separately) and a commercially available microSD™ memory card.

Names of Parts

From the Front

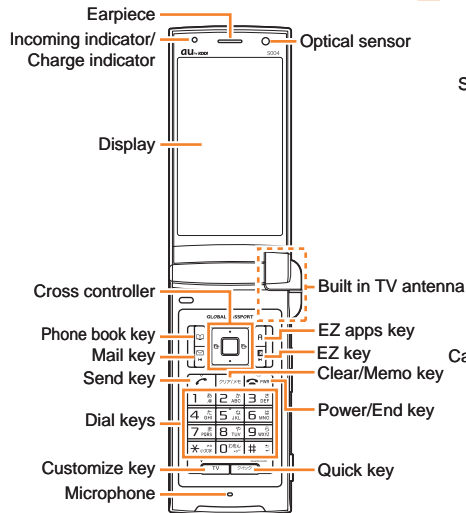

From the Back

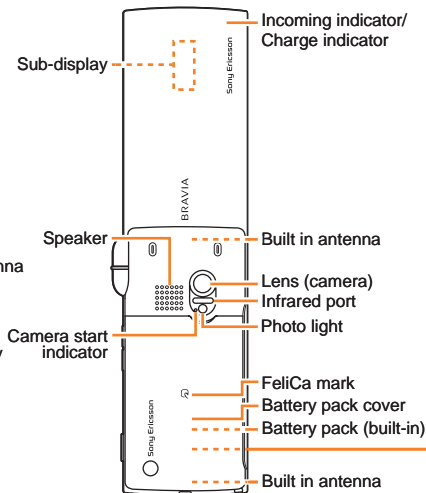

From the Sides

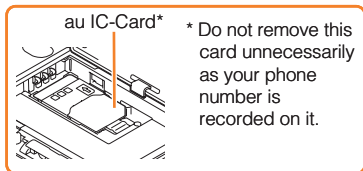
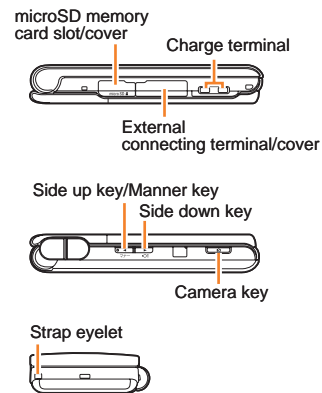

Charging the Battery Pack

The battery pack is not fully charged at the time of purchase. Be sure to charge the battery pack before using the cell phone for the first time.

- An AC adapter is not included. Purchase a specified AC adapter (sold separately).

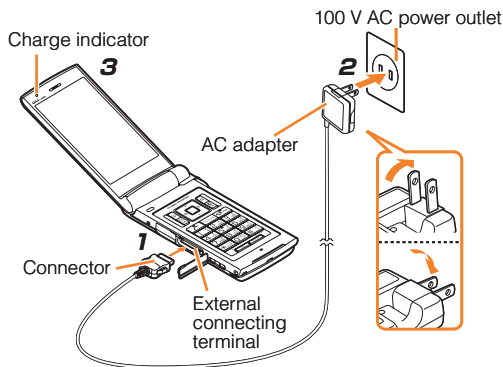

➔ Connect a specified AC adapter to the cell phone with the battery pack attached.

- Open the cover of the external connecting terminal. Check the shape of the connector of the AC adapter, and plug it straight into the external connecting terminal.

➔ Unfold the power plug of the AC adapter and plug it into a 100 V AC power outlet.

➔ Confirm that the charge indicator lights.

- Charging: The charge indicator lights.
- Charging finished: The charge indicator goes out.

- Be sure to close the cover of the external connecting terminal when charging is finished.
- Do not pull or twist the cover of the external connecting terminal forcibly.
- Be sure to use the common AC adapter 02 (sold separately) when charging overseas.

Learning the Basics

Key Assignments

☎ : Display Incoming History.
 ☎ : Display Notification window/Shortcut menu.
 📖 : Use Phone Book.
 📧 : Display E-mail/C-mail menu.
 クリア/メモ : Set/cancel Answer memo. Delete characters. Cancel operation.
 ☎ : Make/answer calls.
 TV : Activate function assigned to M59 *Customize Key*.



🔍 : Display the ticker field, info pane and search window.
 ☎ : Display Outgoing History.
 ● : Display Main menu.
 A : Display EZapps menu.
 E : Display EZ Service menu.
 PWR : Turn power on/off. End call/communication. Cancel operation.
 0 ~ 9 * # : Input phone numbers and characters.
 クイック : Display QuickAccess menu.

Side Key Assignments

マナー : Set/cancel manner mode.
 照明 : Light assist light.
 カメラ : Activate Camera.

• If you lose track of where you are or if you make a mistake, press **クリア/メモ** to return to the previous screen. Return to the standby screen by holding down **PWR** for at least one second.

Hiding/Redisplaying the Notification Window

When the Notification window is displayed on the standby screen, you can temporarily hide it by pressing  (Back) and then display the Main menu by pressing .

To redisplay the hidden Notification window, press  when the standby screen is displayed.

Notification window

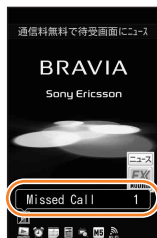

→ Use  to select **画面表示** (Screen Display) and then press  (選択 [Select]).

→ Use  to select **Set Language** and then press  (選択 [Select]).

→ Use  to select **English** and then press  (Set).

Initial Setup of E-mail and EZweb

To use e-mail and EZweb, you need to apply for an EZweb subscription. If you did not apply for an EZweb subscription at the time of purchase, contact an au shop or the au Customer Service Center.

Also, before use, you need to configure initial settings. Your e-mail address is assigned automatically in the initial setup.



When the standby screen is displayed, press .

→ Press  (OK).



After a short while, your e-mail address is displayed.

→ Press  (OK).

The initial settings are complete.

- You can also configure initial settings by pressing  or .

Checking Your Phone Number and E-mail Address

When the standby screen is displayed, press  and then .

Turning On Power

Hold down  for at least one second.

- You cannot receive or make calls if **Out** (out of range indicator) is displayed.

Turning Off Power

When the standby screen is displayed, hold down  for at least one second.

Switching the Display Language to English

You can switch the display language for function names and other items to English.

When the standby screen is displayed, press .

→ Use  to select **機能/設定** (Func/Settings) and then press  (選択 [Select]).

Display Indicators

Display indicators inform you of mail arrival, current settings, etc.

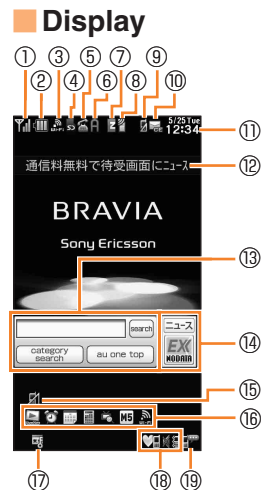

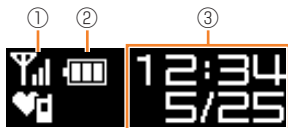

Indicator	Description
①	Signal strength
②	Battery level
③	Wi-Fi WIN connection status
	Overseas (CDMA)/(GSM) mode set
	Packet communication available
④	A microSD™ memory card (sold separately) inserted
⑤	During a call
	au Media Tuner activated
⑥	EZapps activated
⑦	Connecting to EZweb
⑧	Receiving EZ News EX information
⑨	Missed calls
⑩	New or unread e-mail/C-mail
⑪	— Current date and time
⑫	— Ticker field
⑬	— Search window
⑭	— Info pane
⑮	— Notification icon
⑯	— Shortcut menu
⑰	Auto Lock or Remote Ctrl Lock activated
⑱	Manner mode set
⑲	Answer memo or manner mode set

Sub-display





Indicator	Description
①	Signal strength
②	Battery level
③	Current date and time

- The date and time are set automatically. However, auto time adjustment is invalid when *Area Setting* is set to overseas mode. Set the date and time manually under *M551 Auto Time Adj.*
- Press   to switch the sub-display screen.

Using Main Menu

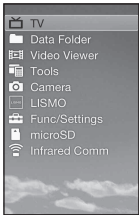
You can access various functions from the Main menu.
Each Main menu pattern has a different set of items.

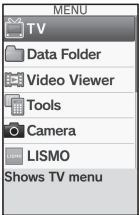

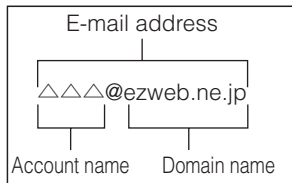

BRAVIA	Sky	Flow	ericle	でか文字 (Large Font)
				
Infrared Comm	TV	Infrared Comm	Infrared Comm	TV
Camera	Data Folder	Camera	Camera	Data Folder
Tools	Video Viewer	Video Viewer	Video Viewer	Video Viewer
LISMO	Tools	LISMO	LISMO	Tools
TV	Camera	Data Folder	TV	Camera
Video Viewer	LISMO	TV	Data Folder	LISMO
Global Function	Func/Settings	Tools	Tools	PC Site Viewer
Data Folder	microSD	microSD	microSD	Func/Settings
Func/Settings	Infrared Comm	Func/Settings	Func/Settings	Global Function
EZ FeliCa		Global Function		microSD
microSD		PlayNow		EZ FeliCa
PC Site Viewer		PlayNow Kisekai		Infrared Comm

Changing Your E-mail Address







You can change the account name of your e-mail address.



When the standby screen is displayed, press .

- ➔ Use  to select *E-mail Setup* and then press .
- ➔ Use  to select *Other* and then press .

The cell phone connects to the server.

- ➔ Use  to select *Eメールアドレスの変更(Change E-mail Address)* and then press .
- ➔ Use  to select the entry box, press , enter your security code, and then press .
 - Your security code is the four-digit number you wrote on your subscription form.
 - If the security code is incorrectly entered three times consecutively during a single day, the e-mail address change operation will be disabled until the next day.
- ➔ Use  to select *送信(Send)* and then press .

- ➔ Use  to select *承諾する(Accept)* and then press .
 - ➔ Use  to select the entry box, press , enter an e-mail address using single-byte alphanumeric characters, and then press .
 - For details on entering e-mail addresses, see page 24.
 - ➔ Use  to select *送信(Send)* and then press .
 - ➔ Use  to select *OK*, press  and then .
 - Check that the e-mail address has been updated before pressing .
- Your e-mail address cannot be changed if the new address you enter in the above procedure is already being used. In this case, enter a different e-mail address.

Security Code and Passwords

You can use a security code and other passwords described below.

Take care not to forget your security code and passwords, because they are required for performing various operations and using subscription services.

Security Code

Usage Example	<ul style="list-style-type: none">①Using the Answering Service (Voice Mail) and Call Transfer remotely from a fixed-line phone②Making inquiries, applications, and changes while using au Customer Service Center voice guidance, au web pages, and EZweb③Changing the settings of <i>Mail Filter</i> or <i>Other</i> under E-mail Setup
Initial Setting	The four-digit number you wrote on your subscription form

Lock No.

Usage Example	Changing various settings of the cell phone
Initial Setting	1234

EZ Password

Usage Example	Subscribing or canceling subscriptions to EZweb fee-based contents
Initial Setting	The four-digit number you wrote on your subscription form

Premium EZ Password

Usage Example	<ul style="list-style-type: none">①Subscribing or canceling subscriptions to EZweb fee-based contents paid by <i>まとめてau 支払い</i> (au Collective Payment Service)②Purchasing products from EZweb sites using <i>まとめてau 支払い</i> (au Collective Payment Service)
Initial Setting	The four-digit number you wrote on your subscription form

Answering a Call

To answer a call, press .

- To end the call, press .

Display When a Call is Received

The phone number of the caller appears.



If the caller's phone number and name are in the phone book, the name is also displayed.

When the phone number of the caller is not displayed, one of the following indicators may appear.

Indicator	Meaning
<i>ID Unsent</i>	The caller did not send a Caller ID.
<i>Payphone</i>	The call is from a pay phone.
<i>Not support</i>	The call is from a phone that does not support Caller ID.

Missed Call Notification

If you did not answer a call,  and *Missed Call* are displayed to let you know that you missed a call.

To check the caller's phone number, use  to select *Missed Call* and then press  (Select). You can then return the call (see the procedure on the right).

Returning a Call (Outgoing History/Incoming History)

Example: Returning a call to a phone number in the incoming history

When the standby screen is displayed, press .

- Press  while the standby screen is displayed to display the Outgoing History screen.

➔ Use  to select the phone number you want to call and then press  (Detail).

- Press  to display the Outgoing History screen.

➔ Press .

- The cell phone can store up to 50 phone numbers in each of the incoming and outgoing history.

One-ring Calls

What is a One-ring Call?



A one-ring call is a call from an unknown caller that only rings once, causing it to be stored in the incoming history. One-ring calls are often used to get you to return the call, which will connect you to a dating service or some other service that charges you at high rates.

One-ring Indicator

 indicator (red) on the Incoming History screen indicates you have received a one-ring call (a call rang for three seconds or shorter). Be careful when you return a call to an unknown caller.

Adjusting the Earpiece Volume during a Call



During a call, use .

- : Increases the volume.
- : Decreases the volume.

➔ Press  (OK).



Turning On Manner Mode

When the standby screen is displayed, hold down  for at least one second.

This turns on manner mode, and displays  on the standby screen. This also turns on Answer memo, which is indicated by  on the standby screen.

Turning Off Manner Mode



When the standby screen is displayed, hold down  for at least one second.



Turning off manner mode causes  to disappear from the standby screen. Answer memo is also turned off, which is indicated by  disappearing from the standby screen.



- Even in manner mode, the cell phone still emits a sound when autofocusing, a shutter sound when you take a photo.



Changing the Incoming Ring Tone

When the standby screen is displayed, press .

➔ Use  to select *Func/Settings* and then press  (Select).

➔ Use  to select *Sound/Vib/Lamp* and then press  (Select).

➔ Use  to select *Incoming Setup* and then press  (Select).

➔ Use  to select *Incoming Call* and then press  (Select).

➔ Use  to select *Ringtone* and then press  (Select).

➔ Use  to select *Original* and then press  (Select).

➔ Use  to select a ring tone and then press  (Set).















The incoming ring tone is set.

- If you press  (Play), the tone plays.

➔ Press  (OK).

Adjusting the Incoming Ring Tone Volume

When the standby screen is displayed, press .

- ➔ Use  to select *Func/Settings* and then press  (Select).
- ➔ Use  to select *Sound/Vib/Lamp* and then press  (Select).
- ➔ Use  to select *Incoming Setup* and then press  (Select).
- ➔ Use  to select *Incoming Call* and then press  (Select).
- ➔ Use  to select  (Ringtone Volume) and then press  (Select).
- ➔ Use  to adjust the volume and then press  (Set).
 - Each press of  changes the volume one step.

<i>STEP</i> ↑	The ring tone volume gradually increases.
<i>STEP</i> ↓	The ring tone volume gradually decreases.
<i>Level5</i> ↑ <i>Level3</i> ↓ <i>Level1</i>	The ring tone sounds at the set volume.
<i>OFF</i>	The ring tone does not sound.

➔ Press  (OK).

Turning On the Answer Memo

When the standby screen is displayed, hold down

 for at least one second.

 is displayed on the standby screen.

Turning Off the Answer Memo

When the standby screen is displayed, hold down  for





at least one second. The answer memo is turned off and

 disappears from the standby screen.

- The cell phone can record a maximum of ten messages, each up to 60 seconds (up to 20 seconds in Overseas (GSM) mode) long.
- Answer memo is a function that automatically answers calls and allows callers to record messages. Use the Answering Service (Voice Mail) when your phone is turned off or when you are in a location where a signal cannot be received.













Playing a Message

If a message is recorded, *Answer Memo* appears on the standby screen.

- ➔ Use  to select *Answer Memo* and then press  (Select).
- ➔ Use  to select the message you want to play and then press  (Play).
 - To stop playing the message, press  (Stop).

Deleting a Message

When the standby screen is displayed, press .

- ➔ Use  to select *Answer Memo* and then press  (Select).
- ➔ Use  to select *Answer Memo List* and then press  (Select).
- ➔ Use  to select the message you want to delete and then press  (SubMenu).
- ➔ Use  to select *Delete* and then press  (OK).
- ➔ Use  to select *Delete One* and then press  (OK).
- ➔ Use  to select *YES* and then press  (OK).

Global Function

The S004 supports Global Passport CDMA/GSM services. You can use your S004 overseas without any additional application.

Setting the Area

Example: Setting to Overseas (Auto) mode



When the standby screen is displayed, press .



➔ **Use  to select *Global Function* and then press  (Select).**

Precautions are displayed.

➔ **Check the precautions and then press  (OK).**

➔ **Use  to select *Area Setting* and then press  (Select).**

➔ **Use  to select *Overseas (Auto)* and then press  (Select).**

➔ **Use  to select *YES* and then press  (OK).**

- Some functions are not available when *Area Setting* is not set to *Japan*.

Obtaining the Latest PRL (Preferred Roaming List)

Manually update and set the PRL (preferred roaming list) before traveling abroad.

When the standby screen is displayed, press .

➔ **Use  to select *Global Function* and then press  (Select).**

Precautions are displayed.

➔ **Check the precautions and then press  (OK).**

➔ **Use  to select *PRL Setting* and then press  (Select).**

➔ **Use  to select *PRL Manual Update* and then press  (Select).**

The cell phone connects to the server.

➔ **Use  to select *PRLダウンロード (Download PRL)* and then press  (*ダウンロード [Download]*).**

The latest PRL is downloaded.

- The PRL (preferred roaming list) is the area information of overseas carriers offering international roaming service in partnership with KDDI (au).

- To obtain (download) the PRL, you need to subscribe to EZweb and make initial settings (see page 10) while in Japan.

Calling Japan from Overseas

When the standby screen is displayed, use  to  to enter a phone number.

➔ Press  (Call).

➔ Use  to select *Voice Call* and then press .

➔ Use  to select *Call to Japan* and then press .

➔ Press  (Call).

- When you make an international call from Japan to a Global Passport CDMA/GSM-compatible cell phone, you can do it in the same way as making domestic calls within Japan.

Character Input

Character Entry Modes

When a character entry screen is displayed, you can select a character entry mode if you press  (ChrTyp).

Menu Items

漢 : Kanji conversion mode

力 : Double-byte katakana mode

加 : Single-byte katakana mode

A : Double-byte alphanumeric mode

aA : Single-byte alphanumeric mode

1 : Double-byte number mode

12 : Single-byte number mode













- Each time you press  (ChrTyp), the character entry mode changes in following order: Alphanumeric → Number → Kanji conversion → Katakana → Alphanumeric...
- The character entry mode that you can select is different depending on the current character entry screen.

Entering Alphanumeric Characters

You can use the keys  to  to enter characters.

More than one character is assigned to each key.

The following table shows the key assignment for entering characters.



	Number of Times to Press the Key											
Key	1	2	3	4	5	6	7	8	9	10	11	12
	.	@	-	_	/	:	~	?	,	'	!	1
	a	b	c	A	B	C	2					
	d	e	f	D	E	F	3					
	g	h	i	G	H	I	4					
	j	k	l	J	K	L	5					
	m	n	o	M	N	O	6					
	p	q	r	s	P	Q	R	S	7			
	t	u	v	T	U	V	8					
	w	x	y	z	W	X	Y	Z	9			
	Space	0	Inputs symbols									
	Inputs symbols (switches an unconfirmed character between uppercase and lowercase).											
	Adds a line break (displays an unconfirmed character in the opposite order).											

When you change your e-mail address, you cannot use the characters in  for the account name (part of the address to the left of @).

Entering Two or More Characters Assigned to the Same Key

After you enter the first character, press  and then enter the next character.

Deleting Characters

To delete one character at a time, move the cursor to the character you want to delete and then press . To delete all characters to the right of the cursor, hold down  for at least one second. If there are no characters to the right of the cursor, holding down  for at least one second will delete all the characters.

Starting a New Line

Press .

- Certain functions such as C-mail do not support entering new lines.

Entering E-mail Addresses









E-mail Address Compatible Characters

- Before you enter an e-mail address, switch to the Single-byte alphanumeric mode.
- When changing your e-mail address, you can enter up to 30 single-byte alphanumeric and symbol characters for the account name (part to the left of @). Note the following:
 - Uppercase characters cannot be used.
 - Period (.) or zero (0) cannot be used as the first character.

How to Enter E-mail Addresses

Example: Entering "taro.23@kddi.co.jp"





Enter "taro.23".

- t : Press  once.
- a : Press  once.
- r : Press  three times.
- o : Press  three times.
- . : Press  once.
- 2: Press  once and then .
- 3: Press  once and then .

➔ Enter "@".

- @: Press  twice.

➔ Enter "kddi" and then press (OK).

- k: Press  twice.
- d: Press  once and then .
- d: Press  once.
- i : Press  three times.

- ➔ Press **[R]** (SubMenu).
- ➔ Use **↻** to select *Phrase* and then press **⊙** (OK).
- ➔ Use **↻** to select *Internet* and then press **⊙** (Select).
- ➔ Use **↻** to select *.co.jp* and then press **⊙** (Select).
".co.jp" is entered.

Entering Pictograms/Symbols/ Face marks

Example: Entering pictograms

When a character entry screen is displayed, press **[E]**.

- ➔ Use **↻** to select the pictogram you want to enter and then press **⊙** (OK).
 - You can enter pictograms consecutively if you press **[R]** (Repeat) instead of **⊙** (OK).
- Each time you press **[E]** in the character entry screen, the character entry mode changes in following order: Pictograms → Decoration-Emojis → Symbols → Face marks...
 - You can switch categories of pictograms, decoration-emojis or face marks by pressing **[X]/[#]** on each selection screen.



Phone Book

Saving a Phone Book Entry



When the standby screen is displayed, hold down  for at least one second.

➔ Use  to select  [Name] and then press  (Select).

➔ Enter a name and then press  (OK).
The  [Reading] for the name is entered automatically.



➔ Use  to select  [Phone No.1] and then press  (Select).

➔ Enter a phone number and then press  (OK).
• If the phone number is for a fixed-line phone, enter the phone number starting with the area code.

➔ Use  to select a phone number type and then press  (Select).
• Follow the next step to enter an e-mail address. If you do not want to enter an e-mail address, press  (Reg).

➔ Use  to select  [E-mail Address1] and then press  (Select).

➔ Enter an e-mail address and then press  (OK).



➔ Use  to select an e-mail address type and then press  (Select).

➔ Press  (Reg).

- The phone book can store up to 1,000 entries.
- The cell phone automatically saves an entry to the lowest available memory number from 000 to 999.
- You can save five phone numbers and five e-mail addresses for each phone book entry.
- You can also assign a group No., and enter birthday, address, and other information.

Dialing from the Phone Book

When the standby screen is displayed, press .

➔ Use  to select the entry containing the phone number you want to dial and then press  (Detail).

➔ Use  to select the phone number and then press  (Select).

➔ Use  to select *Voice Call* and then press  (OK).



Editing Phone Book Entries

When the standby screen is displayed, press .

➔ Select an entry and press  (Detail).



➔ Press  (Edit).

➔ Edit the contents and then press  (Reg).

➔ Use  to select *Overwrite* and then press  (OK).

Saving a Phone Number from the Incoming or Outgoing History

Example: Saving a phone number from the incoming history to the phone book

When the standby screen is displayed, press  and use  to select the phone number you want to save.

➔ Press  (SubMenu).

➔ Use  to select *Reg to Adrs Book* and then press  (OK).

➔ Use  to select *Register New* and then press  (Select).

➔ Use  to select a phone number type and then press  (Select).

- For details on saving a phone book entry, see page 26.

Mail

Using E-mail



















To use e-mail, you need to apply for an EZweb subscription. If you did not apply for an EZweb subscription at the time of purchase, contact an au shop or the au Customer Service Center. Also, before use, you need to configure initial settings.

You can send and receive e-mail with other cell phones that support e-mail, and with PCs. In addition to text messages of up to 5,000 double-byte (or 10,000 single-byte) characters, you can also send photos and movies by e-mail.

- The packet communication charge for sending and receiving e-mail applies to the amount of data sent and received.
- You can send an e-mail message to up to 30 different addresses at one time.
- You can send up to 1,000 e-mail messages per day (a message with multiple recipients is counted as more than one message).
- Sending and receiving e-mail messages that include attachment data may take a while.



Creating and Sending E-mail Messages

When the standby screen is displayed, press .



- ➔ Use  to select *Create New* and then press  (Select).
- ➔ Use  to select *Address* and then press  (Select) twice.
- ➔ Use  to select *Address Book* and then press  (Select).
- ➔ Use  to select a phone book entry and then press  (Detail).
- ➔ Use  to select an address and then press  (Select).
- ➔ Press  (OK).
- ➔ Use  to select *Subject* and then press  (Select).
- ➔ Enter a subject and then press  (OK).
 - You cannot enter single-byte katakana characters or a new line in a subject.
- ➔ Use  to select *Text* and then press  (Select).
- ➔ Enter text and then press  (OK).
 - You cannot enter single-byte katakana characters.
- ➔ Press  ( Send).

Reading Received E-mail Messages

When you receive an e-mail message, *E-mail* appears on the standby screen.



➔ Use  to select *E-mail* and then press  (Select).

➔ Press  (Select).

- : Indicates a read message.
- : Indicates an unread message.

➔ Use  to select the new message and then press  (Select).

■ Reading an E-mail Message from the E-mail Menu

When the standby screen is displayed, press  to display the E-mail menu, use  to select *Inbox* and then press  (Select).



For subsequent operations, see "Reading Received E-mail Messages" above.

Reading an E-mail Message with an Attached Photo or Movie

Example: Viewing an attached photo

Display the e-mail message that has an attached photo (above).

➔ Use  to select the file name and then press  (Select).

➔ Use  to select the file name and then press  (Receive).

➔ Press  (Play).

- Selecting the file name or pressing  (Receive) may be unnecessary for some files to be displayed, depending on the file size.

Replying to Received E-mail Messages

When the standby screen is displayed, press .

➔ Use  to select *Inbox* and then press  (Select).

➔ Press  (Select).

➔ Use  to select the message you want to reply to and then press  (Select).

➔ Press  (Reply).

"Re:" is prefixed to the subject, and the text of the message is quoted.

➔ Refer to "Creating and Sending E-mail Messages" (page 28) for subsequent operations.













Rejecting Spam

Setting mail filters to reject spam is recommended. The サポート設定 (Supportive Settings) helps you to set mail filters easily by answering questions that appear on the screen.

Setting Mail Filters

Example: Connecting to サポート設定 (Supportive Settings)

When the standby screen is displayed, press .

- ➔ Use  to select *E-mail Setup* and then press  (Select).
- ➔ Use  to select *Mail Filter* and then press  (Select).
- ➔ Use  to select *次へ (Next)* and then press  (Select).
- ➔ Use  to select the input box and then press  (Input).
- ➔ Enter your security code and then press  (OK).
- ➔ Use  to select *送信 (Send)* and then press  (Select).
- ➔ Use  to select *サポート設定 (Supportive Settings)* and then press  (Select).

カンタン設定 (Simple Settings)

サポート設定 (Supportive Settings)	Set the filter by answering questions This is recommended for users who want to configure settings while confirming conditions.
フィルターレベル (高) Filter Level (High)	Shut out all mail from PCs This is recommended for users who only want to send mail to and receive mail from cell phones.
フィルターレベル (中) Filter Level (Medium)	Block spoof e-mail and mail from specific addresses This is recommended for users bothered by certain senders or spam mail.
フィルターレベル (低) Filter Level (Low)	Block spoof e-mail This is the minimum level recommended for all users.

- You can also prevent spam by changing your e-mail address. For details on changing your e-mail address, see page 14.

Using C-mail

C-mail is a service that uses phone numbers as addresses to exchange messages between au cell phones that support C-mail. A C-mail message can contain up to 50 double-byte (or 100 single-byte) characters.

- The C-mail send charge applies when sending C-mail.









C-mail Safety Block





C-mail safety block is a function that allows you to reject C-mails that include URLs (<http://△△△>, <https://△△△>) or phone numbers in the C-mail message text.

C-mail safety block is valid by default. Cancel the setting if you want to receive C-mails that include URLs and phone numbers in the message text.

Creating and Sending C-mail Messages







When the standby screen is displayed, hold down  for at least one second.

- ➔ Use  to select *Create New* and then press .
- ➔ Enter text and then press  (OK).
- ➔ Use  to select  [Address] and then press  (Edit).
- ➔ Use  to select *Quote Adrs Book* and then press  (OK).



- ➔ Use  to select a phone book entry and then press  (Detail).
- ➔ Use  to select a phone number and then press  (Select).
- ➔ Press  (Send).

Reading Received C-mail Messages

When you receive a C-mail message, *C-mail* appears on the standby screen.

- ➔ Use  to select *C-mail* and then press  (Select).
- ➔ Press  (Select).
 - : Indicates a read message.
 - : Indicates an unread message.
- ➔ Use  to select the new message and then press  (View).

Reading a C-mail Message from the C-mail Menu

When the standby screen is displayed, hold down  for at least one second to display the C-mail menu, use  to select *Inbox* and then press  (Select). For subsequent operations, see "Reading Received C-mail Messages" above.

Camera

Your cell phone has a CMOS camera with 8.08 effective megapixels for shooting photos and movies. You can use the self-timer and autofocus.

Shot images can be used for the standby screen, and attached to e-mail messages.

Photo Taking Tips

When taking photos, frame the subject within the display and hold the cell phone steady to avoid shaking.

Portrait Position

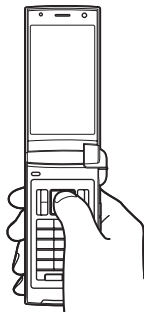

Landscape Position

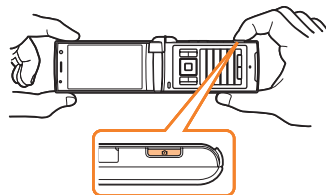

About Photo Modes

The following modes are available for taking photos. W.paper (F.Wide) is set for W.paper mode and 8M is set for DSC mode at the time of purchase.

Mode	Photo Size	Storage Location
W.paper mode	W.paper (Normal)	The <i>Photo Folder</i> in the Data Folder of the cell phone
	W.paper (Wide)	
	W.paper (F.Wide)	
DSC mode	0.3M	The <i>DSC Folder</i> in the Data Folder of a microSD™ memory card (sold separately)*
	1M	
	2M (Wide)	
	3M	
	5M	
	8M	

* When a microSD™ memory card (sold separately) is not inserted, the files are saved to the Data Folder of the cell phone.



- Take care not to cover the lens with a strap or finger.

➔ Use  to select the photo you want to view and then press  (Select).

Taking a Photo



When the standby screen is displayed, hold down  for at least one second.

The monitor screen appears.

➔ Point the AF frame at the subject, press  halfway to focus and then press  fully/ (Shoot).

The shutter clicks, and the preview screen is displayed.

Saving a Photo

Press  (Save)/ on the preview screen.



- If you do not want to save the photo, press  in the preview screen.

Viewing Photos

When the standby screen is displayed, press .

➔ Use  to select *Data Folder* and then press  (Select).

➔ Use  to select *Photo Folder* and then press  (Select).

➔ Use  to select a folder and then press  (Select).

EZweb is an information service that allows you to enjoy browsing the Internet on your cell phone. You can also download Chaku-Uta-Full®, Chaku-Uta®, news, and other contents from web pages.

To use EZweb, you need to apply for an EZweb subscription. If you did not apply for an EZweb subscription at the time of purchase, contact an au shop or the au Customer Service Center. Also, before use, you need to configure initial settings.

- The packet communication charge for EZweb connection applies to the amount of data sent and received, not to the length of time connected.
- In addition to communication charges, some sites charge for providing information.

Accessing Sites

■ Viewing the au one Top

You can access EZweb from the au one Top. A variety of useful and fun sites are available on EZweb.

When the standby screen is displayed, press **[E]**, use **[↑]** to select *Top Menu/Search* and then press **[Select]** (Select).



キーワード検索機能 (Search by Keyword)
Provides a search function for searching for information by keyword.

カテゴリ(メニューリスト) (Category (Menu List))
Provides a list of various content provider sites.

トップニュース (Top News)
Provides automatic updates of the latest news.

最新オススメ情報 (Latest News)
Introduces up-to-date information concerning entertainment, daily life, etc.

天気・乗換・テレビ・占い (Weather, Transportation, TV & Horoscope)
Provides direct access to these au one services.

買う (Shopping & Auctions)
Provides a list of shopping and auction sites available from your cell phone.

知る (Tips & Tools)
Provides information on sports and stock prices, as well as useful tools such as maps and dictionaries.

楽しむ (Hobbies & Culture)
Provides the latest information, such as games, music, books, hobbies and entertainment.

暮らす (Lifestyle)
Provides travel, restaurant and other lifestyle-oriented information.

集まる (Community)
Provides interesting and useful information that you can use for SNS or blogs.

au style
Introduces information and sites that au recommends.

とくする情報 (Valuable Information)
Presents gifts and push information to the EZweb subscriber for free.



auお客さまサポート (au Customer Support)
Provides information about charges, various applications, au online manual and notices from au.



カンタンアクセス・オープンサイト (Simple Access & Open Site)
Provides easy access and introduces open sites.

災害用伝言板 (Disaster Message Board)
Register and confirm safety information in time of disaster.











ENGLISH
Introduces English sites.

Basic Operations

Use  to select the site you want to access and then press  (Select).

Press  or  to return to the previous screen. Hold down either key for at least one second to return to the au one Top.

The following describes the basic operations that are available while accessing sites.

Key Operation	Description
	Exits EZweb.
	Moves the cursor up and down. When there is data available above or below the current screen, scrolls up and down the screen one line at a time.
 /  / 	When there is data available above or below the current screen, scrolls the screen page by page.  /  : Scrolls one page up.  /  : Scrolls one page down.
 / 	Returns to the previous screen.

Bookmarking Frequently Accessed Pages

When the page you want to bookmark is displayed, press  (BrowserMenu).

➔ Use  to select *Favorites* and then press  (OK).

➔ Use  to select *Add Bookmark* and then press  (OK).

- Some pages cannot be bookmarked.

➔ Press  (Reg).



The displayed page is bookmarked, and its title and URL are added to the Bookmark.

- The Bookmark can contain up to 100 titles and URLs.

Viewing Bookmarked Pages

When the standby screen is displayed, press  and then use  to select *EZweb*.

➔ Use  to select *Bookmark(s)* and then press  (Select).

➔ Use  to select the bookmark for the page you want to view and then press  (Connect).
The cell phone connects to the site.

Checking Charges

When the standby screen is displayed, press **⊙**.

- ➔ Use **⬅** to select *Func/Settings* and then press **⊙** (Select).
- ➔ Use **⬅** to select *Time/Toll/Sub* and then press **⊙** (Select).
- ➔ Use **⬅** to select *Inquire Toll* and then press **⊙** (Select).
- ➔ Use **⬅** to select *YES* and then press **⊙** (OK).
 - Select the item you want to check and then follow the on-screen instructions.

Downloading Chaku-Uta-Full®/ Chaku-Uta®

When the standby screen is displayed, press **E** and then use **⬅** to select *EZweb*.

- ➔ Use **⬅** to select *Top Menu/Search* and then press **⊙** (Select).
- ➔ Use **⬅** to select *カテゴリ (メニューリスト)* (Category (Menu List)) and then press **⊙** (OK).
- ➔ Use **⬅** to select *着うた (Chaku-Uta®)* or *着うたフル・ビデオクリップ (Chaku-Uta-Full®・Video Clip)* and then press **⊙** (Select).

- ➔ Use **⬅** to select the site you want to access and then press **⊙** (Select).
- ➔ Follow the on-screen instructions to select and download a data.
 - Fee-based information sites require entry of EZ password or Premium EZ password. Follow the on-screen instructions to enter either password. See page 15 for details.
- ➔ **Download is completed.**
 - Downloaded data is saved automatically to the Data Folder.
- ➔ Press **▶** (Play).

The downloaded Chaku-Uta-Full® or Chaku-Uta® plays.

 - This procedure is only an example for the purpose of explanation and may differ from actual procedures. Follow the instructions on the site from which you want to download the data.

Use the EZ News EX to display the latest news, weather forecast, horoscope and others that are delivered free of packet communication charges on the standby screen. You can view detailed information on a news item or weather forecast by selecting the ticker field or info pane.

You must fill out an application and pay information charges to use all of the EZ News EX services.

You can use the EZ News EX by making a few simple settings following the EZweb initial setup.

Basic Operations

When the standby screen is displayed, press  to select the ticker field.

You can view detailed information on a news item or weather forecast.

- You can also select the info pane.
- The EZ News EX information is automatically received at no charge. Note, however, that packet communication charges may be incurred for manual updates and connecting to EZweb sites. In this case, a confirmation screen for network connection is displayed.
- The EZ News EX information is updated at regular time intervals.  appears while receiving information.

Setting EZ News EX

The EZ News EX is available free of charge. You have only to make a few simple settings. After following the procedure in "Initial Setup of E-mail and EZweb" on page 10, configure EZ News EX settings. If you did not configure the EZ News EX settings at the time of the initial setup, follow the steps below.

When the standby screen is displayed, select the ticker field and then press  (OK).

➔ Follow the on-screen instructions.

The setup procedure is completed.

- When the standby screen returns, a message asking you to wait for a while until the next update takes place appears in the ticker field.

■ Canceling EZ News EX

When the standby screen is displayed, select the ticker field and then press **●** (News).

- ➔ Press **Ⓐ** (サブメニュー [Submenu]), use **⬆** to select **サービス利用設定変更・解除 (Service Settings/Cancellation)** and then press **●** (選択 [Select]).
- ➔ Use **⬆** to select **サービス利用解除 (Service Cancellation)** and then press **●** (選択 [Select]).
- ➔ Follow the on-screen instructions.

■ Changing the Reception Settings for EZ News EX Information

You can change the ring tone, vibrator and lamp settings under M216 *NewsFlash Receive* for reception of EZ News EX information.

If you do not want the ring tone to sound when receiving EZ News EX information, set the volume to *OFF*.

Using GPS (Global Positioning System), EZ Navi provides useful positional information services.

When the standby screen is displayed, press  and then use  to select EZnavi.

- The packet communication charges for using EZ Navi services apply to the amount of data sent and received. Some services may require a separate information fee.
- Before using EZ Navi, you must configure initial settings of EZweb (page 10).

Passenger Seat Navi for People in the Passenger Seat to Check the Route

Passenger Seat Navi guides the passengers to the destination with the best route using voice and map.

Drivers are not allowed to use Passenger Seat Navi.

Security Navi to Check Where Your Kids Are

The Security Navi application is made up of the following three functions:

いつでも位置確認 (Auto Position Search [monthly charge]),
エリア通知 (Area Message [no monthly charge]),
位置確認メール (Position Search Mail [no monthly charge])

Using these functions, you can check the position of an au cell phone that supports Security Navi; and automatically receive a notification from the specified au cell phones when your kids enter (or are in) or leave (or are no longer in) the set area within a predetermined period of time.

EZ Navi Walk for When You Go Out

Displays various useful menu items for when you are out. There are two menu modes: the Full Mode menu for those who want to use all the convenient functions including the latest features, and the Simple Mode menu with limited functions allowing you to use the service with simple operation.

The following table describes the Full Mode menu.

フリーワード検索 (Free Word Search)	Search by entering names of facilities and stores, or key words of stations and addresses.
トータルナビ／地図 (Total Navigation/Map)	Find the most preferable combination of transportation (trains, airplanes, buses and taxis), and check out maps of your current location and places you like to go.
乗換／時刻表 (Connection/Timetable)	Search for train connections, timetables and other public transportation information.
お店／施設／イベント (Shop/Facility/Event)	Search for local stores, facilities or events.
ドライブ／渋滞情報 (Road/Traffic Information)	Check out road traffic information in real time.
オススメ便利メニュー (Useful Menu)	View information on services that are available on PCs, and use advanced functions of EZ Navi Walk that you can enjoy.

設定／会員登録／インフォ
(Setting/Membership
Registration/Information)

Configure various settings, sign up as a member or check out various useful information.

- Some of the menu options require a monthly charge.

Map of Your Current Location



★ represents your initial location. As you start moving, changes of your location are tracked by continuous positioning and indicated in real time by 📍.

The *現在地の地図* (Map of Your Current Location) option displays the current map in real time.

3D Navi

Shows a 3D view at guidance points and around the destination area.

Evacuate Navi to Guide You Home or to Nearby Evacuation Areas during Disasters

Nearby public evacuation areas or the direction to your home can be determined using the map data pre-installed on the S004 (避難所マップ[Evacuate Area Map]). Other useful contents can be downloaded from the 災害時ナビ (Evacuate Navi) section of the EZweb site.

- Some contents require a monthly charge.
- Use the information on the screen as a reference and always follow the instructions of police, fire and other municipal authorities.
- When using Evacuate Navi, checking your current position may take more time than usual depending on the status of the GPS satellites.

TV (1Seg)

EZweb Subscription Required

"1Seg", a mobile terrestrial digital television service in Japan, is available on the S004.

Using the TV Antenna

When watching TV (1Seg), do not cover the TV antenna part with your hands to ensure good reception.

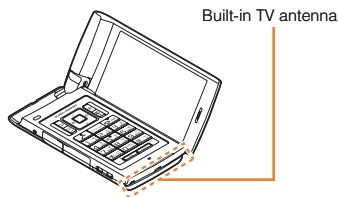

- Before using TV, you must configure initial settings of EZweb (page 10).
- If you are watching TV indoors, you may be able to improve the reception by moving closer to a window.

- The continuous viewing times of TV (1Seg) are as follows. The figures vary according to the usage of data broadcasts.

Continuous viewing time	Using earphones	DBEX ON: Approx. 3 hrs 50 min. DBEX OFF: Approx. 3 hrs 50 min.
	Using the speaker	DBEX ON: Approx. 3 hrs 50 min. DBEX OFF: Approx. 3 hrs 50 min.

- For information about the "1Seg" service, refer to the following homepage.
The Association for Promotion of Digital Broadcasting.

From a PC	http://www.dpa.or.jp/
From a cell phone	http://www.dpa.or.jp/1seg/k/

Initial Setup of au Media Tuner

To watch TV (1Seg) using the au Media Tuner, you need to configure initial settings.



When the standby screen is displayed, press .

➔ Use  to select TV, press  (Select), use  to select TV (1Seg) and then press  (Select).
Disclaimer notes are displayed.

➔ Use  to check the disclaimer notes, use  to select OK, and then press  (選択 [Select]).

The initial setting screen for using the au Media Tuner is displayed.

- Follow the on-screen instructions to configure each setting. Then, the screen for setting TV (1Seg) channels appears.





➔ Use  to select オート設定 (放送波) (Auto (Broadcasting wave)) and then press  (選択 [Select]).

Automatic channel scanning begins. When receivable channels are found, the channel setup is completed.

- Select マニュアル設定 (Manual) to set the channel manually.

Watching TV (1Seg)

When the standby screen is displayed, press .

➔ Use  to select TV, press  (Select), use  to select TV (1Seg) and then press  (Select).

To Change Channels

Use  to change channels.

You can select TV (1Seg) and EZ Channel-Plus/EZ Channel programs.

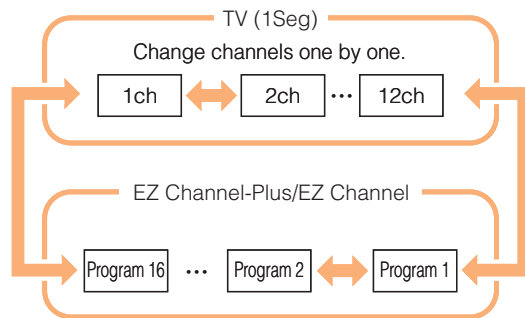

- Before using this feature, you must configure au Media Tuner initial settings (see the procedure on the left).
- Channels cannot be changed with  when the data operation screen is displayed.



Basic Operations

Launch TV (1Seg) to start receiving data broadcasts.

The data operation screen appears when a data broadcast is received. Press  (Vol/Ch) on the data operation screen to switch to the TV operation screen.

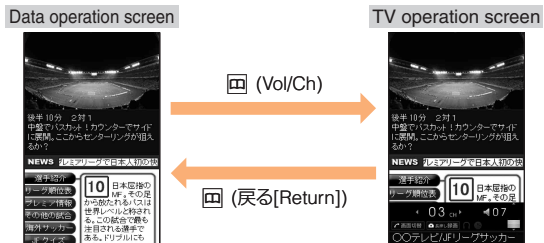
On the TV operation screen, pressing  switches the display.



- Use   to adjust the volume.

Exiting the au Media Tuner

Press , use  to select **はい** (YES) and then press  (OK).

In Case of Loss of Your S004

The Remote Ctrl Lock allows you to remotely activate the Auto Lock, FeliCa Lock, and Address Book Lock, preventing others from using your cell phone.

Setting Conditions for Activating the Remote Ctrl Lock

You can activate the Remote Ctrl Lock by calling your S004 a set number of times from a registered phone number within a specified period of time.

When the standby screen is displayed, press **⊙**.

- ➔ Use **⊕** to select *Func/Settings* and then press **⊙** (Select).
- ➔ Use **⊕** to select *Privacy/Rstr* and then press **⊙** (Select).
- ➔ Use **⊕** to select *Security Lock* and then press **⊙** (Select).
- ➔ Use **⊕** to select *Rem. Ctrl Lock* and then press **⊙** (Select).
- ➔ Enter Lock No., and then press **⊙** (OK).
- ➔ Use **⊕** to select *Valid No.* and then press **⊙** (Select).
- ➔ Use **⊕** to select *[Register New]* and then press **⊙** (Select).

- ➔ Use **⊕** to select *Direct Input*, press **⊙** (OK), enter a phone number, and then press **⊙** (OK).
- ➔ Press **Ⓐ** (Comp).
- ➔ Use **⊕** to select *Duration (min)* and then press **⊙** (Select).
- ➔ Enter a time and then press **⊙** (Set).
 - This sets the time limit for receiving the set number of calls after the first call is received.
 - You can set a time from one to ten minutes.
- ➔ Use **⊕** to select *No. of Incm*, and then press **⊙** (Select).
- ➔ Enter a number of calls, and then press **⊙** (Set).
 - This sets the number of calls to receive to activate the Remote Ctrl Lock.
 - You can set a number of calls from three to ten.
- ➔ Press **Ⓐ** (Save).
- ➔ Use **⊕** to select *YES* and then press **⊙** (OK).

Remotely Activating the Remote Ctrl Lock on Your S004

Call the S004 from the registered phone number repeatedly within the set time limit.

- When the specified number of calls are received, the Remote Ctrl Lock is activated and a message plays telling you that the cell phone is locked.

Activating the Remote Ctrl Lock by the Security Lock Service

Even if the Remote Ctrl Lock is not set in advance, the Remote Ctrl Lock can be activated by calling au Customer Service Center or completing the application process on au Customer Support from a PC.

The Security Lock Service is available free of charge.

Calling au Customer Service Center to Activate/Cancel the Remote Ctrl Lock

From an au cell phone: 113 without a prefix (toll free)

From any other cell phone or fixed-line phone:

 0077-7-113 (toll free)

Open 24 hours







Follow the voice guidance to complete the application process.



Activate/Cancel the Remote Ctrl Lock from a PC

Login to au Customer Support (<https://cs.kddi.com/>) and complete the application process by following the on-screen instructions.

- The Remote Ctrl Lock cannot be activated when the S004 is turned off or out of the service area, or Emission OFF is set to *ON*.
- You must fill out an application to use au Customer Support (the application can be filled out even after your cell phone is lost).

Troubleshooting

Symptom	Possible Cause	Remedy	Page
Cannot turn on power.	● Is the battery pack charged?	Charge the battery pack.	8
	● Did you hold down  for at least one second?	Hold down  for at least one second.	10
Cannot make calls.	● Is power turned on?	Hold down  for at least one second.	10
	● Is Out (out of range indicator) displayed?	Move to a location where Out (out of range indicator) is no longer displayed, and try again. Also check the <i>Area Setting</i> .	10,21
	● Is your hand or a metal object covering the area around the built-in antenna?	Make sure your hand or any other metal object is not covering the area around the built-in antenna.	7
	● Did you enter the phone number starting with the area code?	When making a call to a phone other than a cell phone, you need to enter the area code even if you are inside the same area.	16
Cannot receive calls.	● Is Out (out of range indicator) displayed?	Move to a location where Out (out of range indicator) is no longer displayed. Also check the <i>Area Setting</i> .	10,21
	● Is power turned on?	Hold down  for at least one second.	10
No response when a key is pressed.	● Is power turned on?	Hold down  for at least one second.	10
A warning tone sounds and power turns off.	● Is there enough power left in the battery pack?	Charge the battery pack.	8
Calls are answered automatically.	● Is Answer memo turned on?	Hold down  for at least one second to turn off Answer memo.	19

Symptom	Possible Cause	Remedy	Page
Cannot hear the other party.	● Is the earpiece volume too low?	Press  during a call to increase the earpiece volume.	18
When making a call, a beeping sound is heard from the earpiece and a connection cannot be established.	● Is Out (out of range indicator) displayed? Or are you in a location where the signal is too weak?	Move to a location where Out (out of range indicator) is no longer displayed. Also check the <i>Area Setting</i> .	10,21
	● Is the wireless line busy or is the phone you are calling on another line?	End the call and try again later.	16
The incoming indicator flashes but the ring tone does not play.	● Is manner mode turned on?	Hold down  for at least one second to turn off manner mode.	18
	● Is  (ring tone off indicator) displayed?	Increase the volume of the incoming call ring tone.	19
Cannot charge the battery pack.	● Is the battery pack installed properly?	Install the battery pack properly.	8
	● Are the plug and connector of the AC adapter inserted properly?	Insert the plug and connector firmly.	
When the camera is activated, no subject is displayed.	● Is a finger or other object covering the lens (camera)?	Check the position of the lens (camera) and remove the obstacle.	7

- For more detailed information, visit the following au troubleshooting sites:
 - From an au cell phone:  ⇒ *Top Menu/Search* ⇒ *auお客さまサポート* (au Customer Support) ⇒ *オンラインマニュアル* (Online Manual) ⇒ *故障診断Q&A* (Troubleshooting FAQ)
 - From a PC: <http://www.kddi.com/customer/service/au/trouble/kosho/index.html>

Index

Numeric

1Seg 43

A

Accessories 6

Answer memo 19

 Playback 19

 Turning off 19

 Turning on 19

B

Battery level 11

Battery pack 6,8

Battery pack cover 7

C

C-mail 31

 C-mail safety block 31

 Creating and sending 31

 Reading 31

 Received mail 31

Camera 32

 Photo taking tips 32

 Taking a photo 33

Cell phone etiquette 2

Character input 23

 Character entry modes 23

 Deleting characters 24

 Entering characters from the same key 24

 Starting a new line 24

Charging the battery pack 8

Checking charges 37

Contents 4

D

Disaster Message Board Service 3

Display 7,11

Domain 14

Downloading Chaku-Uta-Full® 37

Downloading Chaku-Uta® 37

E

E-mail 28

 Creating and sending 28

 Initial settings 10

 Reading 29

 Received mail 29

 Replying 29

 Viewing attached images 29

E-mail address 10

 Available characters 23

 Changing 14

 Entering 24

Earpiece volume 18

Entering pictograms/symbols/face marks 25

Evacuate Navi 42

EZ Navi	40
EZ Navi Walk	41
EZ News EX	38
Canceling	39
Changing the Reception Settings	39
Info pane	11
Setting	38
Ticker field	11
EZ password	15
EZweb	34
Accessing sites	35
au one Top	35
Basic operations	36
Initial settings	10

G

Global Function	21
Calling Japan from overseas	22
Obtaining the latest PRL (Preferred Roaming List)	21
Setting the area	21

I

Incoming history	17
Indicators	11
Initial settings	10,44
au Media Tuner	44
E-mail · EZweb	10
TV (1Seg)	44
International Call	16
Internet	34
Sites	35,36

K

Key assignments	9
-----------------------	---

L

Language	10
Learning the basics	9
Lock No.	15

M

Mail	28
C-mail	31
E-mail	28
Mail filters	30
Simple settings	30
Main menu	13
Manner mode	18

N

Names of parts	7
Notification window	10

O

One-ring calls	17
Outgoing history	17

P

Passenger Seat Navi	40
Passwords	15

Phone (call)	16	Security Navi	40
184/186	16	Signal strength	11
Answering	17	Sites	35
International Call	16	Bookmarking	36
Making	16	Viewing from bookmarks	36
Returning	17	Spam	30
Phone book	26	Sub-display	12
Dialing	26		
Editing	26	T	
Saving	26	Troubleshooting	48
Saving a phone number from the incoming or outgoing history	27	Turning on/off power	10
Phone number	10	TV (1Seg)	43
Photos	32	Antenna	43
Photo modes	32	Basic operations	45
Taking	33	Changing channels	44
Viewing	33	Exiting	45
Playback		Initial settings	44
Answer memo	19		
Premium EZ password	15	V	
		Viewing	
R		Photos	33
Remote Ctrl Lock	46		
Ringtones			
Changing the type	18		
Changing the volume	19		
S			
Security code	15		
Security Lock Service	47		

Radio Wave Exposure and Specific Absorption Rate (SAR) Information

★ Mobile Phone GSM/GPRS 900/1800/1900

United States & Canada

THIS PHONE MODEL HAS BEEN CERTIFIED IN COMPLIANCE WITH THE GOVERNMENT'S REQUIREMENTS FOR EXPOSURE TO RADIO WAVES.

The S004 mobile phones have been designed to comply with applicable safety requirements for exposure to radio waves. Your wireless phone is a radio transmitter and receiver. It is designed to not exceed the limits* of exposure to radio frequency (RF) energy set by governmental authorities. These limits establish permitted levels of RF energy for the general population. The guidelines are based on standards that were developed by international scientific organizations through periodic and thorough evaluation of scientific studies. The standards include a safety margin designed to assure the safety of all individuals, regardless of age and health.

The radio wave exposure guidelines employ a unit of measurement known as the Specific Absorption Rate (SAR). Tests for SAR are conducted using standardized methods with the phone transmitting at its highest certified power level in all used frequency bands. While there may be differences between the SAR levels of various phone models, they are all designed to meet the

relevant guidelines for exposure to radio waves. For more information on SAR, please refer to the safe and efficient use chapter in the User Guide.

The highest SAR value as reported to the authorities for this phone model when tested for use by the ear is 0.87 W/kg*, and when worn on the body is 0.56 W/kg* for speech and 0.58 W/kg* for data calls. Body worn measurements are made while the phone is in use and worn on the body with a Sony Ericsson accessory supplied with or designated for use with this phone. It is therefore recommended that only Ericsson and Sony Ericsson original accessories be used in conjunction with Sony Ericsson phones.

**Before a phone model is available for sale to the public in the US, it must be tested and certified by the Federal Communications Commission (FCC) that it does not exceed the limit established by the government-adopted requirement for safe exposure*. The tests are performed in positions and locations (i.e., by the ear and worn on the body) as required by the FCC for each model. The FCC has granted an Equipment Authorization for this phone model with all reported SAR levels evaluated as in compliance with the FCC RF exposure guidelines. While there may be differences between the SAR levels of various phones, all mobile phones granted an FCC equipment authorization meet the government requirement for safe exposure. SAR information on this phone model is on file at the FCC and can be found under the Display Grant section of <http://www.fcc.gov/oet/ea> after searching on FCC ID PY7A5880007. Additional information on SAR can be found on the Cellular Telecommunications & Internet Association (CTIA) website

at <http://www.ctia.org>.

* In the United States and Canada, the SAR limit for mobile phones used by the public is 1.6 watts/kilogram (W/kg) averaged over one gram of tissue. The standard incorporates a margin of safety to give additional protection for the public and to account for any variations in measurements.

** This paragraph is only applicable to authorities and customers in the United States.

■ Europe

This mobile phone model S004 has been designed to comply with applicable safety requirements for exposure to radio waves. These requirements are based on scientific guidelines that include safety margins designed to assure the safety of all persons, regardless of age and health.

The radio wave exposure guidelines employ a unit of measurement known as the Specific Absorption Rate, or SAR. Tests for SAR are conducted using standardized methods with the phone transmitting at its highest certified power level in all used frequency bands.

While there may be differences between the SAR levels of various phone models, they are all designed to meet the relevant guidelines for exposure to radio waves.

For more information on SAR, please refer to the safety

chapter in the User's Guide.

SAR data information for residents in countries that have adopted the SAR limit recommended by the International Commission of Non-Ionizing Radiation Protection (ICNIRP), which is 2 W/kg averaged over ten (10) gram of tissue (for example European Union, Japan, Brazil and New Zealand):

The highest SAR value for this model phone tested by Sony Ericsson for use at the ear is 0.69 W/kg (10g).

Radio Frequency (RF) exposure and Specific Absorption Rate (SAR)

When your phone or Bluetooth handsfree is turned on, it emits low levels of radio frequency energy. International safety guidelines have been developed through periodic and thorough evaluation of scientific studies. These guidelines establish permitted levels of radio wave exposure. The guidelines include a safety margin designed to assure the safety of all persons and to account for any variations in measurements.

Specific Absorption Rate (SAR) is used to measure radio frequency energy absorbed by the body when using a mobile phone. The SAR value is determined at the highest certified power level in laboratory conditions, but because the phone is designed to use the minimum power necessary to access the chosen network, the actual SAR level can be well below this value. There is no proof of

difference in safety based on difference in SAR value.

Products with radio transmitters sold in the US must be certified by the Federal Communications Commission (FCC). When required, tests are performed when the phone is placed at the ear and when worn on the body. For body-worn operation, the phone has been tested when positioned a minimum of 15 mm from the body without any metal parts in the vicinity of the phone or when properly used with an appropriate Sony Ericsson accessory and worn on the body. Use of the phone other than as tested may impact SAR and result in non-compliance with such RF exposure limits.

For more information about SAR and radio frequency exposure go to:
www.sonyericsson.com/health.

Guidelines for Safe and Efficient Use

Please follow these guidelines. Failure to do so might entail a potential health risk or product malfunction. If in doubt as to its proper function, have the product checked by a certified service partner before charging or using it.



Recommendations for care and safe use of our products

- Handle with care and keep in a clean and dust-free place.
- **Warning!** May explode if disposed of in fire.

- Do not expose to liquid or moisture or excess humidity.
- For optimum performance, the product should not be operated in temperatures below +5°C (+41°F) or above +35°C (+95°F). Do not expose the battery to temperatures above +35°C (+95°F).
- Do not expose to flames or lit tobacco products.



- Do not drop, throw or try to bend the product.
- Do not paint or attempt to disassemble or modify the product.



- Consult with authorized medical staff and the instructions of the medical device manufacturer before using the product near pacemakers or other medical devices or equipment.
- Discontinue use of electronic devices or disable the radio transmitting functionality of the device where required or requested to do so.
- Do not use where a potentially explosive atmosphere exists.
- Do not place your product or install wireless equipment in the area above an air bag in a car.
- **Caution:** Cracked or broken displays may create sharp edges or splinters that could be harmful upon contact.
- Do not use the Bluetooth Headset in positions where it is uncomfortable or will be subject to pressure.

Children



Warning! Keep out of the reach of children. Do not allow children to play with mobile phones or accessories. They could hurt themselves or others. Products may contain small parts that could become detached and create a choking hazard.

Power supply (Charger)

Connect the charger to power sources as marked on the product. Do not use outdoors or in damp areas. Do not alter or subject the cord to damage or stress. Unplug the unit before cleaning it. Never alter the plug. When a power supply is connected there is a small drain of power. To avoid this small energy waste, disconnect the power supply when the product is fully charged.

Battery

New or idle batteries can have short-term reduced capacity. Fully charge the battery before initial use. Use for the intended purpose only. Charge the battery in temperatures between +5°C (+41°F) and +35°C (+95°F). Do not put the battery into your mouth. Do not let the battery contacts touch another metal object. Turn off the product before removing the battery. Performance depends on temperatures, signal strength, usage patterns, features selected and voice or data transmissions. Use of an unqualified battery may present a risk of fire, explosion, leakage or other hazard.

Personal medical devices

Mobile phones may affect implanted medical equipment. Reduce risk of interference by keeping a minimum distance of 22cm (8.7 inches) between the phone and the device. Use the phone at your right ear. Do not carry the phone in your breast pocket. Turn off the phone if you suspect interference. For all medical devices, consult a physician and the manufacturer.

Driving

Some vehicle manufactures forbid the use of phones in their vehicles unless a handsfree kit with an external antenna supports the installation. Check with the vehicle manufacturer's representative to be sure that the mobile phone or Bluetooth handsfree will not affect the electronic systems in the vehicle. Full attention should be given to driving at all times and local laws and regulations restricting the use of wireless devices while driving must be observed.

GPS/Location based functions

Some products provide GPS/Location based functions. Location determining functionality is provided "As is" and "With all faults". KDDI/Sony Ericsson does not make any representation or warranty as to the accuracy of such location information.

Use of location-based information by the device may not be uninterrupted or error free and may additionally be dependent on network service availability. Please note that functionality may be reduced or prevented in certain environments such as building interiors or areas adjacent to buildings.

Caution: Do not use GPS functionality in a manner which causes distraction from driving.

Emergency calls

Calls cannot be guaranteed under all conditions. Never rely solely upon mobile phones for essential communication. Calls may not be possible in all areas, on all networks, or when certain network services and/or phone features are used.

Flight mode

Bluetooth and WLAN functionality, if available in the device, can be enabled in Flight mode but may be prohibited onboard aircraft or in other areas where radio transmissions are prohibited. In such environments, please seek proper authorisation before enabling Bluetooth or WLAN functionality even in Flight mode.

Malware

Malware (short for malicious software) is software that can harm the mobile phone or other computers. Malware or harmful applications can include viruses, worms, spyware, and other unwanted programs. While the device does employ security measures to resist such efforts, KDDI/Sony Ericsson does not warrant or represent that the device will be impervious to introduction of malware. You can however reduce the risk of malware attacks by using care when downloading content or accepting applications, refraining from opening or responding to messages from unknown sources, using trustworthy services to access the Internet, and only downloading content to the mobile phone from known, reliable sources.

Accessories

Use only KDDI original accessories. KDDI/Sony Ericsson does not test third-party accessories. Accessories may influence RF exposure, radio performance, loudness, electric safety and other areas. Third-party accessories and parts may pose a risk to your health or safety or decrease performance.

Disposal of old electrical and electronic equipment



Electronic equipment and batteries should not be included as household waste but should be left at an appropriate collection point for recycling. This helps prevent potential negative consequences for the environment and human health. Check local regulations by contacting your local city office, your household waste disposal service, the shop where you purchased the product or calling a Sony Ericsson call centre. Do not attempt to remove internal batteries. Internal batteries shall be removed only by a waste treatment facility or trained service professional.

Disposing of the battery



Check local regulations or call a Sony Ericsson call centre for information. Never use municipal waste.

Memory Card

If the product comes complete with a removable memory card, it is generally compatible with the handset purchased but may not be compatible with other devices or the

capabilities of their memory cards. Check other devices for compatibility before purchase or use. If the product is equipped with a memory card reader, check memory card compatibility before purchase or use.

Memory cards are generally formatted prior to shipping. To reformat the memory card, use a compatible device. Do not use the standard operating system format when formatting the memory card on a PC. For details, refer to the operating instructions of the device or contact customer support.

Warning!

If the device requires an adapter for insertion into the handset or another device, do not insert the card directly without the required adapter.

Precautions on memory card use

- Do not expose the memory card to moisture.
- Do not touch terminal connections with your hand or any metal object.
- Do not strike, bend, or drop the memory card.
- Do not attempt to disassemble or modify the memory card.
- Do not use or store the memory card in humid or corrosive locations or in excessive heat such as a closed car in summer, in direct sunlight or near a heater, etc.
- Do not press or bend the end of the memory card adapter with excessive force.
- Do not let dirt, dust, or foreign objects get into the insert port of any memory card adapter.
- Check you have inserted the memory card correctly.

- Insert the memory card as far as it will go into any memory card adapter needed. The memory card may not operate properly unless fully inserted.
- We recommend that you make a backup copy of important data. We are not responsible for any loss or damage to content you store on the memory card.
- Recorded data may be damaged or lost when you remove the memory card or memory card adapter, turn off the power while formatting, reading or writing data, or use the memory card in locations subject to static electricity or high electrical field emissions.

Protection of personal information

Erase personal data before disposing of the product. To delete data, perform a master reset. Deleting data from the phone memory does not ensure that it cannot be recovered. KDDI/Sony Ericsson does not warrant against recovery of information and does not assume responsibility for disclosure of any information even after a master reset.

Loudness warning!

Avoid volume levels that may be harmful to your hearing.

FCC Statement for the USA

This device complies with Part 15 of the FCC rules. Operation is subject to the following two conditions:

- (1) This device may not cause harmful interference, and
- (2) This device must accept any interference received, including interference that may cause undesired operation.



Any change or modification not expressly approved by Sony Ericsson may void the user's authority to operate the equipment.

This equipment has been tested and found to comply with the limits for a Class B digital device, pursuant to Part 15 of the FCC Rules. These limits are designed to provide reasonable protection against harmful interference in a residential installation. This equipment generates, uses and can radiate radio frequency energy and, if not installed and used in accordance with the instructions, may cause harmful interference to radio communications. However, there is no guarantee that interference will not occur in a particular installation.

If this equipment does cause harmful interference to radio or television reception, which can be determined by turning the equipment off and on, the user is encouraged to try to correct the interference by one or more of the following measures:

- Reorient or relocate the receiving antenna.
- Increase the separation between the equipment and receiver.
- Connect the equipment into an outlet on a circuit different from that to which the receiver is connected.
- Consult the dealer or an experienced radio/TV technician for help.

Industry Canada Statement

This Class B digital apparatus complies with Canadian ICES-003.

Cet appareil numérique de la classe B est conforme à la norme NMB-003 du Canada.

This device complies with RSS-210 of Industry Canada. Operation is subject to the following two conditions:

- (1) this device may not cause interference, and
- (2) this device must accept any interference, including interference that may cause undesired operation of the device.

Declaration of Conformity for CDMA S0004

We, Sony Ericsson Mobile Communications AB of Nya Vattentorget SE-221 88 Lund, Sweden declare under our sole responsibility that our product

Sony Ericsson type AAH-5880007-BV

and in combination with KDDI AC-charger 02 (0203PQA version C) and Sony Earphone (MDR-E0921SP) to which this declaration relates is in conformity with the appropriate standards EN 301 511:V9.0.2, EN 301 489-7:V1.3.1, EN 300 440-2:V1.3.1, EN 301 489-3:V1.4.1, EN 300 328:V1.7.1, EN 301 489-17:V2.1.1 and EN 60950-1:2006, following the provisions of Radio Equipment and Telecommunication Terminal Equipment Directive 1999/5/EC

Lund, April 2010

C E0682

Signature



Dan Redin,
Corporate Vice President and Head of Development

われわれはR&TTE指令の要求事項を満たしています(1999/5/EC)
We fulfill the requirements of the R&TTE Directive (1999/5/EC)

For inquiries, call: au Customer Service Center

For general information and charges (toll free)

From fixed-line phones:

 0077-7-111

From au cell phones:

157 area code not required

PRESSING ZERO WILL CONNECT YOU TO AN OPERATOR
AFTER CALLING 157 ON YOUR au CELL PHONE

For loss, theft or damage and operation information
(toll free)

From fixed-line phones:

 0077-7-113

From au cell phones:

113 area code not required

In case above numbers are not available,

 0120-977-033 (except Okinawa)

 0120-977-699 (Okinawa)

From EZweb:

Access Method  [Top Menu/Search](#) ▶ [auお客様サポート](#) (au Customer Support)
▶ [お問い合わせ](#) (Inquiries)
* Menus are subject to change without prior notice.

なるほど! au
みんなでつくる、auQ&Aサイト

Access Method  [Top Menu/Search](#) ▶ [auお客様サポート](#) (au Customer Support)
▶ [みんなでQ&A「なるほど! au」](#) (au User's Forum)

Read this code for an easy
access to なるほど! au
(au User's Forum). ▶

- The packet communication charge applies.



Cell phone and PHS operators collect and recycle unused telephones, batteries and battery chargers at stores bearing the ♻️ logo regardless of brand and manufacturer to protect the environment and reuse valuable resources.

Read this code for an easy
access to au Online Manual.
(Packet communication
charges do not apply.)



1236-7923.1
May 2010, 1st Edition

Sales: KDDI CORPORATION
OKINAWA CELLULAR TELEPHONE COMPANY
Manufactured by: Sony Ericsson Mobile Communications Japan, Inc.