

# 70 Series

## Mobile Computer

CK70, CK70NI, CK71, CK71NI, CN70, CN70NI, CN70e, CN70eNI



User Manual

Intermec Technologies Corporation

Worldwide Headquarters

6001 36th Ave.W.

Everett, WA 98203

U.S.A.

[www.intermec.com](http://www.intermec.com)

The information contained herein is provided solely for the purpose of allowing customers to operate and service Intermec-manufactured equipment and is not to be released, reproduced, or used for any other purpose without written permission of Intermec Technologies Corporation.

Information and specifications contained in this document are subject to change without prior notice and do not represent a commitment on the part of Intermec Technologies Corporation.

© 2011 - 2012 by Intermec Technologies Corporation. All rights reserved.

The word Intermec, the Intermec logo, Norand, ArciTech, Beverage Routebook, CrossBar, dcBrowser, Duratherm, EasyADC, EasyCoder, EasySet, Fingerprint, i-gistics, INCA (under license), Intellitag, Intellitag Gen2, JANUS, LabelShop, MobileLAN, Picolink, Ready-to-Work, RoutePower, Sabre, ScanPlus, ShopScan, Smart Mobile Computing, SmartSystems, TE 2000, Trakker Antares, and Vista Powered are either trademarks or registered trademarks of Intermec Technologies Corporation.

There are U.S. and foreign patents as well as U.S. and foreign patents pending.

Wi-Fi is a registered certification mark of the Wi-Fi Alliance.

Microsoft, Windows, and the Windows logo are registered trademarks of Microsoft Corporation in the United States and/or other countries.

Bluetooth is a trademark of Bluetooth SIG, Inc., U.S.A.

## Document Change Record

This page records changes to this document. The document was originally released as Revision 001.

Version Number	Date	Description of Change
005	11/2012	Added information to support firmware version 1.50: <ul style="list-style-type: none"><li>• CloneNGo application</li><li>• New camera settings</li><li>• SceneEditor application</li><li>• EA30 imager extended reading range</li></ul>
004	2/2012	Revised information on ScanNGo bar codes.
003	12/2011	Added information on: <ul style="list-style-type: none"><li>• the flashlight feature.</li><li>• the Carrier Selection application.</li></ul> Revised information on: <ul style="list-style-type: none"><li>• the Intermec Settings menus.</li><li>• upgrading the system software and the operating system.</li><li>• GPS procedures.</li><li>• ScanNGo bar codes.</li></ul>
002	06/2011	Revised to add information on non-incendive (NI) versions of the computer, provisioning the computer, the new ScanDiagnostics application, and how to use the 70 Series as a USB mass storage device. Also corrected the cold boot procedure and removed the compass.



# Contents

Before You Begin .....	xi
Safety Information .....	xi
Global Services and Support .....	xi
Warranty Information .....	xi
Web Support .....	xi
Send Feedback .....	xii
Telephone Support .....	xii
Who Should Read This Manual .....	xii
Related Documents .....	xii
Patent Information .....	xiii

## **1 About the Computer Features** ..... 1

About the 70 Series Mobile Computers .....	2
What's New in This Release .....	4
Overview of 70 Series Features .....	5
About the Status LEDs .....	6
70 Series Accessories .....	8
About Language Provisioning .....	10
About the Battery .....	10
Charge the Battery .....	11
Change the Battery .....	11
About Battery Status .....	13
About Battery Life and Conservation .....	15
About the Keypad .....	16
Enter Characters on the QWERTY Keypad .....	23
Enter Characters on the Numeric Keypad .....	23
Enter Characters on the CK70 and CK71 Keypads .....	24
About the Power Button .....	25
About the Intermec Dashboard Button .....	26
Configure the Screen Backlight .....	27
Configure the Screen Brightness .....	27
Adjust the Volume .....	27
About the Imager .....	28

## Contents

Use the Imager as a Flashlight . . . . .	28
Read Bar Codes . . . . .	29
Insert a MicroSD Card. . . . .	30
Install a MicroSD Card in a CN70 or CN70e . . . . .	30
Install a MicroSD Card in a CK70 or CK71 . . . . .	33
Transfer Files To and From Your PC. . . . .	35
Use Microsoft ActiveSync to Transfer Files . . . . .	36
Use the Computer as a Mass Storage Device . . . . .	37
<b>2 About the User Interface and Intermec Applications . . . . .</b>	<b>39</b>
About the User Interface. . . . .	40
About the Home Screen . . . . .	40
Interact with the Screen . . . . .	41
Title Bar Status Icons . . . . .	42
Align the Screen . . . . .	45
About Intermec Applications. . . . .	45
Applications Available on the Mobile Computer . . . . .	45
Applications You Can Download to the Mobile Computer . . . . .	47
<b>3 Use the Phone . . . . .</b>	<b>51</b>
About the Phone. . . . .	52
Activate the UMTS Phone . . . . .	52
Activate the CDMA Phone . . . . .	54
Start the Activation Wizard . . . . .	56
Turn the Phone On and Off. . . . .	56
About Network Carriers . . . . .	56
Switch Network Carriers. . . . .	57
Add the WWAN Connection . . . . .	58
About the Network Connection . . . . .	59

Make a Phone Call .....	60
Make an Emergency Phone Call .....	60
<b>4 Use the Camera</b> .....	<b>61</b>
About the Color Camera.....	62
About the Camera Settings .....	62
Configure the Camera.....	65
Configure Camera Scenes.....	65
Take a Picture .....	66
Record a Video.....	66
Save Pictures and Videos to a microSD Card.....	67
<b>5 Use GPS</b> .....	<b>69</b>
About the Integrated GPS on Your Computer .....	70
Use the GPSID Installed on the Computer .....	70
About the GPS Module Operating Modes.....	71
Improve GPS Performance on the Computer .....	72
<b>6 Configure the Computer</b> .....	<b>73</b>
How to Configure the Computer .....	74
Use Intermec Settings on the Computer.....	74
Start Intermec Settings .....	75
About the Structure of Intermec Settings .....	75
Navigate in Intermec Settings .....	80
Configure Profile Settings with Intermec Settings .....	80
Restore Default Settings to a Menu.....	81
Restore Default Settings for All Parameters .....	81
Hide Menu Items in Intermec Settings .....	81
Use Intermec Settings Remotely with SmartSystems .....	82

## Contents

About Network Communications . . . . .	82
Configure 802.11a/b/g/n (Wi-Fi) Radio Communications . . . . .	83
Configure Ethernet Communications . . . . .	83
Configure Bluetooth Communications . . . . .	84
About Serial and USB Communications . . . . .	88
Create an ISP Connection . . . . .	89
Create a VPN Server Connection . . . . .	91
About Wireless Security . . . . .	92
Choose Between Microsoft and Funk Security . . . . .	92
Load a Certificate . . . . .	102
<b>7 Manage the Computer . . . . .</b>	<b>105</b>
Manage the Computer in Your Network . . . . .	106
Manage the Computer Using CloneNGo . . . . .	106
Manage the Computer Using SmartSystems . . . . .	106
Manage the Computer Using Third-Party Software . . . . .	108
Develop and Install Applications . . . . .	108
Package Your Application . . . . .	108
Choose a Target Location . . . . .	108
Install Applications Using SmartSystems Foundation Console . . . . .	109
Install Applications Using Microsoft ActiveSync . . . . .	109
Install Applications Using a Storage Card . . . . .	110
Launch Applications Automatically . . . . .	110
Update the System Software . . . . .	110
Update Individual or Multiple Computers Using the SmartSystems Console . . . . .	111
Update Individual Mobile Computers Using a microSD Card . . . . .	112
<b>8 Troubleshoot and Maintain the Computer . . . . .</b>	<b>113</b>
About the Intermec Dashboard . . . . .	114
Troubleshoot Your Mobile Computer . . . . .	115
Troubleshoot the Wi-Fi Connection . . . . .	115
Troubleshoot 802.1x Security . . . . .	116
Check 802.11 Network Status . . . . .	117
Troubleshoot Reading Bar Codes . . . . .	118
Use ScanDiagnostic to Troubleshoot the Scanner . . . . .	120
Troubleshoot Operating the Computer . . . . .	120



Call Product Support . . . . .	122
Find Your Configuration Number . . . . .	122
Find Your Operating System Version . . . . .	123
Reset the Computer . . . . .	123
Reboot the Computer . . . . .	123
Cold Boot the Computer . . . . .	123
Clean Boot the Computer . . . . .	125
Clean the Computer. . . . .	125

## **A Specifications and Default Settings . . . . . 127**

Physical and Environmental Specifications . . . . .	128
CN70 Physical Dimensions . . . . .	128
CN70e Physical Dimensions . . . . .	128
CK70 Physical Dimensions . . . . .	128
CK71 Physical Dimensions . . . . .	128
Environmental Specifications . . . . .	128
Power and Electrical Specifications . . . . .	129
70 Series Non-Incendive Computer Specifications . . . . .	129
Operating System . . . . .	129
Hardware . . . . .	130
Back Accessory Interface Pin-outs . . . . .	130
Touch Screen Specifications . . . . .	130
Standard Communications . . . . .	131
Wireless LAN . . . . .	131
Regulatory Approvals . . . . .	131
Bar Code Symbolologies . . . . .	132
Imager Reading Distances . . . . .	133
Default Configuration. . . . .	142
Data Collection Settings. . . . .	142
Communications . . . . .	145
Device Settings . . . . .	146
GPS Settings . . . . .	149
Core Messaging Service Settings. . . . .	149
Device Monitor Settings. . . . .	149
Virtual Wedge Settings . . . . .	150

<b>B</b>	<b>Keypads and Keystrokes</b> .....	151
	Standard Characters .....	152
	CN70 Keypads and Keystrokes .....	152
	CN70e Keypads and Keystrokes .....	157
	CK70 Keypads and Keystrokes .....	161
	CK71 Keypads and Keystrokes .....	168
<b>C</b>	<b>ScanNGo Wi-Fi Configuration Bar Codes</b> .....	177
	Radio Configuration Bar Codes .....	178
	2D Configuration Bar Codes .....	178
	1D Configuration Bar Codes .....	179
<b>I</b>	<b>Index</b> .....	185

# Before You Begin

This section provides you with safety information, technical support information, and sources for additional product information.

## Safety Information

Your safety is extremely important. Read and follow cautions in this document before handling and operating Intermec equipment. You can be seriously injured, and equipment and data can be damaged if you do not follow the safety cautions.

This section explains how to identify and understand cautions and notes that are in this document.



**A caution alerts you to an operating procedure, practice, condition, or statement that must be strictly observed to prevent equipment damage or destruction, or corruption or loss of data.**



**Note:** Notes either provide extra information about a topic or contain special instructions for handling a particular condition or set of circumstances.

## Global Services and Support

### Warranty Information

To understand the warranty for your Intermec product, visit the Intermec website at [www.intermec.com](http://www.intermec.com) and click **Support > Returns and Repairs > Warranty**.

Disclaimer of warranties: The sample code included in this document is presented for reference only. The code does not necessarily represent complete, tested programs. The code is provided “as is with all faults.” All warranties are expressly disclaimed, including the implied warranties of merchantability and fitness for a particular purpose.

### Web Support

Visit the Intermec website at [www.intermec.com](http://www.intermec.com) to download our current manuals (in PDF).

## **Before You Begin**

Visit the Intermec technical knowledge base (Knowledge Central) at [www.intermec.com](http://www.intermec.com) and click **Support** > **Knowledge Central** to review technical information or to request technical support for your Intermec product.

### **Send Feedback**

Your feedback is crucial to the continual improvement of our documentation. To provide feedback about this manual, please contact the Intermec Technical Communications department directly at [TechnicalCommunications@intermec.com](mailto:TechnicalCommunications@intermec.com).

### **Telephone Support**

In the U.S.A. and Canada, call **1-800-755-5505**.

Outside the U.S.A. and Canada, contact your local Intermec representative. To search for your local representative, from the Intermec website, click **About Us** > **Contact Us**.

## **Who Should Read This Manual**

This manual is written for the person who is responsible for installing, configuring, and maintaining the 70 Series Mobile Computer.

This manual provides you with information about the features of the 70 Series mobile computer, and how to install, configure, operate, maintain, and troubleshoot it.

Before you work with the 70 Series mobile computer, you should be familiar with your network and general networking terms, such as IP address.

## **Related Documents**

This is a list of related Intermec documents.

- *[Intermec Settings Command Reference Manual](#)*
- *[Intermec Developer Library \(IDL\) Resource Kit Developer's Guide](#)*

The Intermec website at [www.intermec.com](http://www.intermec.com) contains our documents (as PDF files) that you can download for free.

## To download documents

- 1 Visit the Intermec website at [www.intermec.com](http://www.intermec.com).
- 2 Click the **Products** tab.
- 3 Using the **Products** menu, navigate to your product page. For example, to find the CN70 computer product page, click **Computers > Handheld Computers > CN70**.
- 4 Click the **Manuals** tab.

If your product does not have its own product page, click **Support > Manuals**. Use the **Product Category**, the **Product Family**, and **Product** to find your documentation.

## Patent Information

Product is covered by one or more of the following patents:

4882476; 4894523; 4953113; 4961043; 4970379; 4988852; 5019699; 5021642; 5038024; 5081343; 5095197; 5144119; 5144121; 5182441; 5187355; 5187356; 5195183; 5216233; 5216550; 5195183; 5195183; 5218191; 5227614; 5233172; 5241488; 5243602; 5258606; 5278487; 5288985; 5308966; 5322991; 5331136; 5331580; 5342210; 5349678; 5359185; 5371858; 5373478; 5389770; 5397885; 5410141; 5414251; 5416463; 5442167; 5464972; 5468947; 5468950; 5477044; 5486689; 5488575; 5500516; 5502297; 5504367; 5508599; 5514858; 5530619; 5534684; 5536924; 5539191; 5541419; 5548108; 5550362; 5550364; 5565669; 5567925; 5568645; 5572007; 5576529; 5592512; 5594230; 5598007; 5608578; 5616909; 5619027; 5627360; 5640001; 5657317; 5659431; 5671436; 5672860; 5684290; 5719678; 5729003; 5742041; 5761219; 5764798; 5777308; 5777309; 5777310; 5786583; 5793604; 5798509; 5798513; 5804805; 5805807; 5811776; 5811777; 5818027; 5821523; 5828052; 5831819; 5834753; 5834749; 5837987; 5841121; 5842070; 5844222; 5854478; 5862267; 5869840; 5873070; 5877486; 5878395; 5883492; 5883493; 5886338; 5889386; 5892971; 5895906; 5898162; 5902987; 5902988; 5912452; 5923022; 5936224; 5949056; 5969321; 5969326; 5969328; 5979768; 5986435; 5987192; 5987499; 5992750; 6003775; 6012640; 6016960; 6018597; 6024289; 6034379; 6036093; 6039252; 6064763; 6075340; 6095422; 6097839; 6102289; 6102295; 6109528; 6119941; 6128414; 6138915; 6149061; 6149063;

***Before You Begin***

6152370; 6155490; 6158661; 6164542; 6164545; 6173893; 6195053;  
6234393; 6234395; 6244512; 6249008; 6328214; 6330975; 6345765;  
6356949; 6367699; 6375075; 6375076; 6375344; 6431451; 6435411;  
6484944; 6488209; 6497368; 6532152; 6538413; 6539422; 6621942;  
6641046; 6681994; 6687403; 6688523; 6732930

There may be other U.S. and foreign patents pending.

# 1

## About the Computer Features

This chapter introduces the 70 Series Mobile Computers with Windows® Embedded Handheld operating system. Use this chapter to learn about the basic features and functions of each computer, as well as the available accessories for it.

# About the 70 Series Mobile Computers

The ergonomically designed Intermec 70 Series Mobile Computers are built on the Microsoft Windows Embedded Handheld operating system. They are lightweight, easy-to-use, and run most software developed for the Windows Embedded platform, including standalone, client-server, and browser-based applications.

The 70 Series family of computers consists of four different models: the CN70, CN70e, CK70 and CK71. The CN70 and CN70e have the same features except that the CN70e offers a larger keypad for data-input intensive applications. The CK70 and CK71 have most of the same features, but the CK71 offers a choice of imager options and does not offer a WWAN radio option (phone). For hazardous environments, Intermec offers non-incendive (NI) models of each 70 Series computer. Throughout this manual, all versions of the mobile computer are referred to as 70 Series unless information is specific to a particular model of computer.

In most of the user manual, pictures of the CN70 and CK70 represent the four models of the 70 Series computers.

## **CN70 Front View**

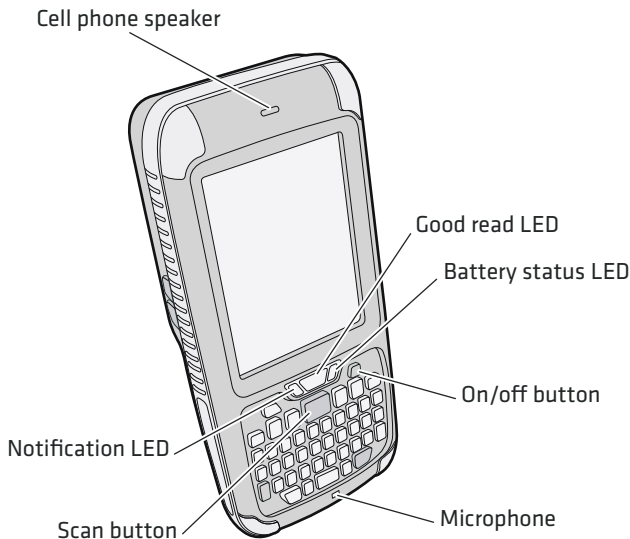



**CN70 Back View**

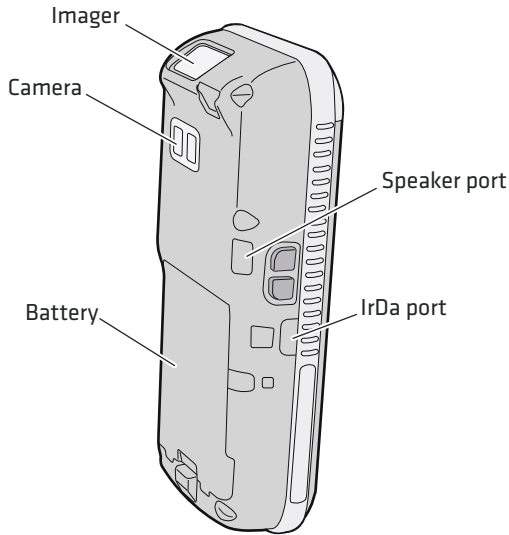

**CK70 and CK71 Front View**



**CK70 and CK71 Back View**

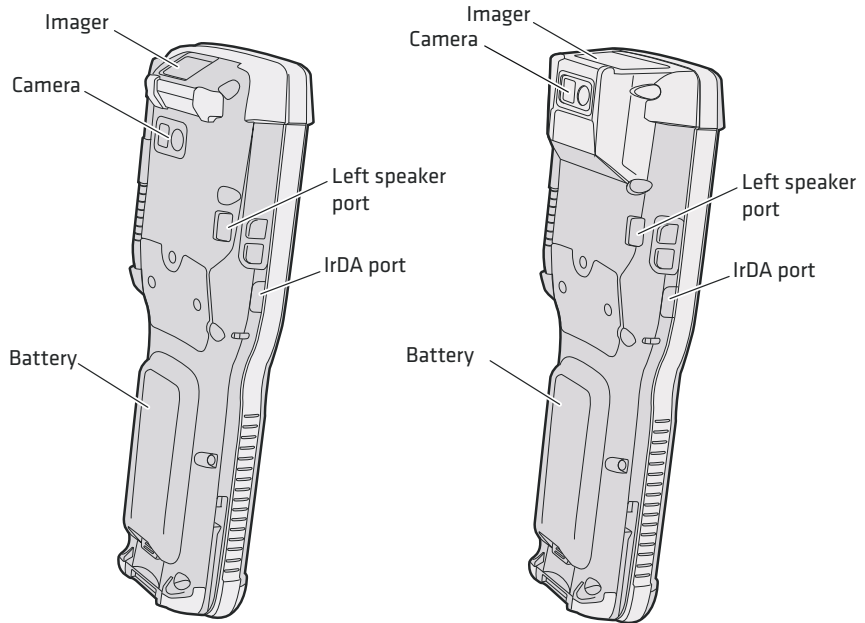

## **What's New in This Release**

This version of the user manual supports firmware version 1.50 and includes information about these new features:

- Intermec CloneNGo is a peer-to-peer device management application that ships on every computer and simplifies the process of configuring multiple computers. For more information, see **“Manage the Computer Using CloneNGo” on page 106.**
- Optimized camera settings make it easier to take good pictures. For more information, see **“About the Camera Settings” on page 62** and **“Configure the Camera” on page 65.**
- The SceneEditor application lets you modify or create your own predefined camera scenes. **“Configure Camera Scenes” on page 65.**
- The EA30 imager provides an extended reading range. For more information, see **“EA30 Typical Reading Distances - Extended Reading Range” on page 134.**

## **Overview of 70 Series Features**

The 70 Series includes these standard features:

- EA30 area imager that can read bar codes and capture images
- (CK71 only) Choice of EA30, EX25, or EV12 imagers
- Multi-processor architecture with 512 MB DRAM and 1G Flash
- CDMA, UMTS, or Flexible Network Radio capability (not available on CK71)
- 802.11a/b/g/n and Bluetooth® radios
- GPS radio on CDMA, UMTS, or Flexible Network Radio computers (not available on CK71)
- 5-megapixel auto-focus color camera
- Customer-accessible microSD slot for memory cards up to 32 GB
- Customer-accessible SIM card slot
- IrDA port with speeds up to 4 Mbps



The 70 Series Mobile Computer with an IEEE 802.11a/b/g/n radio installed is Wi-Fi® certified for interoperability with other 802.11a/b/g/n wireless LAN devices.

## About the Status LEDs

Use the following illustrations and table to understand the status LEDs on your computer. All six status LEDs are not available on every 70 Series computer. For example, the QWERTY versions of the CN70 and CN70e do not have a Green key status LED.

### **Location of the CN70 Status LEDs**

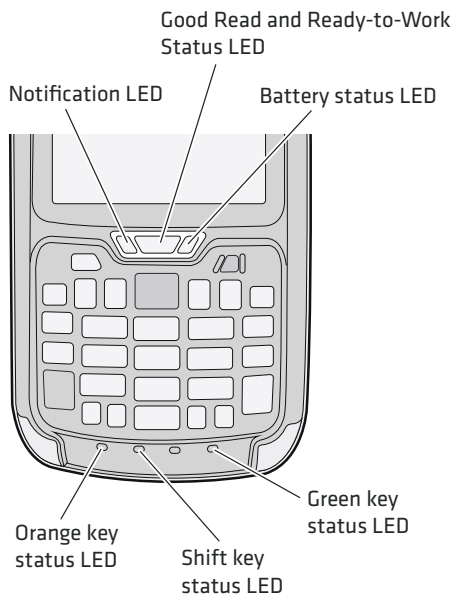

**Location of the CK70 and CK71 Status LEDs**

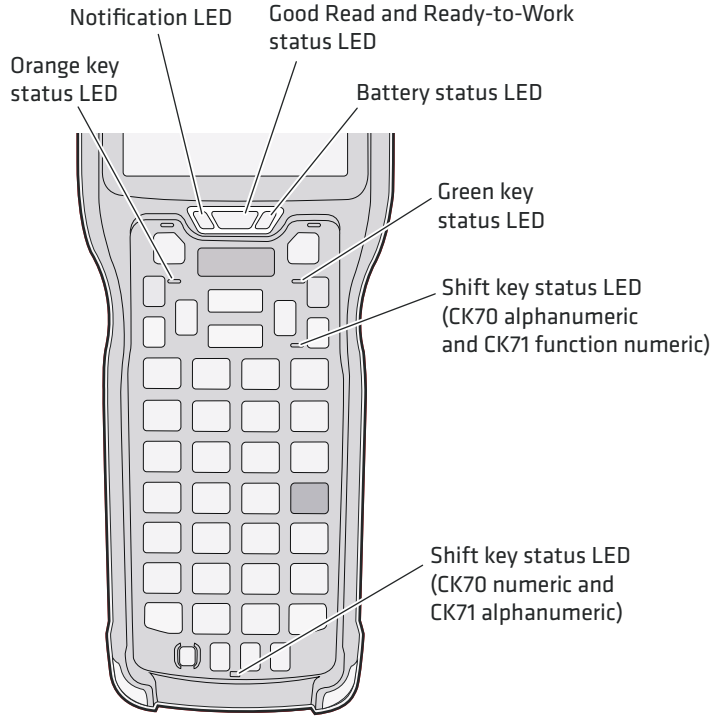

**Status LED Descriptions**

LED	Color	Description
Notification	Amber	This LED is user-programmable.
Good Read	Green	The computer successfully decoded a bar code.
Ready-to-Work	Blue	If you have Intermec Terminal Emulator (ITE), the application is running and connected to the host.
	Blinking blue	If you do not have ITE, you can configure the Ready-to-Work indicator to turn on or off to indicate a healthy state. ITE is running but not connected to the host.
	Off	The computer is unhealthy. ITE is not installed or not running.
Battery		The computer is healthy. See <b>“About Battery Status” on page 13.</b>

<b>LED</b>	<b>Color</b>	<b>Description</b>
Key Status	Green	The Green function key is enabled.
	Orange	The Orange function key is enabled.
Shift	Red	The Shift key is enabled.

## **70 Series Accessories**

The 70 Series computer ships with a battery. All other accessories are sold and ordered separately. For help, contact your local Intermec sales representative.

### **70 Series Accessories**

<b>Accessory</b>	<b>Description</b>
Audio Snap-On Adapter	Use the audio adapter to connect the computer to a headset.
Back Accessory Interface	Use the back accessory interface to attach accessories such as the magstripe reader adapter to the CK70 and CK71.
CK70/CK71 Battery	This battery provides main power to the CK70 and CK71.
CK70/CK71 Magstripe Reader Adapter	Use the magnetic stripe reader to be able to read magnetic cards with the CK70 and CK71 computer.
CN70/CN70e Battery	This battery provides main power to the CN70 and CN70e.
CN70/CN70e Magstripe Reader Snap-On Adapter	Use the magnetic stripe reader to be able to read magnetic cards with the CN70 and CN70e computer.
Desktop Stand	Use the desktop stand to hold the 70 Series computer on your desk or a stable surface.
DEX/UCS Snap-On Adapter	Use this adapter to receive and send serial communications through a DEX/UCS connection.
DX1 Desktop Dock with USB connectivity	Use the desktop dock with the: <ul style="list-style-type: none"><li>• Computer cup to charge the battery while it is installed in the computer.</li><li>• Battery cup to charge the battery.</li></ul>

<b>Accessory</b>	<b>Description</b>
DX2 Dual Dock and DX4 Quad Dock. The DX2 and DX4 are available in charge-only and Ethernet configurations.	Use these charger bases with the: <ul style="list-style-type: none"><li>• Computer cup to charge batteries while they are installed in the computer.</li><li>• Battery cup to charge two batteries.</li></ul>
Ethernet Snap-On Adapter	Use the Ethernet adapter to be able to connect the computer to an Ethernet network.
Handstrap Replacement Kit	You can order and install a replacement handstrap for the CN70, CN70e, and CK70/CK71. Each kit contains 5 handstraps.
Holster	Use the holster to store the computer when you need your hands free.
RS-232 Snap-On Adapter	Use the RS-232 adapter to convert the connector on the bottom of the computer to a serial connector.
Scan Handle	Use the scan handle to provide better ergonomics to the computer for high-volume scanning applications.
Tethered Stylus Replacement Kit	You can order and install a replacement stylus.
USB Snap-On Adapter	Use this adapter to convert the bottom connector of the computer to a USB connector.
Vehicle Dock	Use the vehicle dock to provide power and hold your computer while you are using it in a vehicle.
Vehicle Holder	Use the vehicle holder to hold your computer while you are using it in a vehicle.
Vehicle Power Adapter	Use the vehicle power adapter to provide power to the computer from your vehicle.
Vocollect® Snap-On Adapter	Use this adapter to be able to use the Vocollect voice solution in your warehouse.

## About Language Provisioning

If your 70 Series computer includes language provisioning, you are prompted to select a language provision when the computer starts for the first time. It may take up to 15 minutes to load your language.

These languages are available:

- Chinese Simplified (CHS)
- Chinese Traditional (CHT)
- Spanish (ESN)
- French (FRA)
- German (GER)
- Italian (ITA)
- Japanese (JPN)
- Korean (KOR)
- Russian (RUS)
- World Wide English (WWE)

Make sure you select the correct language before you tap **Provision**. If you want to change the language provisioning, you need to send your computer to an Intermec Global Repair Center.

## About the Battery



**The battery used in this device may present a fire or chemical burn hazard if it is mistreated. Do not disassemble it, heat it above 100 °C (212 °F) or incinerate it. Dispose of used batteries promptly. Keep away from children.**

The computers use these rechargeable Lithium-ion battery pack as the main power source:

- 3.7 V, 4000 mAH (14.8 Wh) battery for the CN70 and CN70e
- 3.7 V, 5200 mAH (19.2 Wh) battery for the CK70 and CK71



## Charge the Battery

You need to fully charge the battery before using your computer for the first time. Use one of the charging accessories listed in the next table to charge the battery.

### 70 Series Charging Accessories

Charging Accessory	Charging Time
Snap-on adapters	Up to 6 hours
DX1, DX2, or DX4 dock	Up to 6 hours
CN70, CN70e, CK70, and CK71 Vehicle Power Adapter	Up to 6 hours

## Change the Battery

If your battery power is low, you need to either charge the battery in the computer, or replace it with a charged battery.

- 1 Save your files and close any open applications.
- 2 Press the **Power** button and choose **Hibernate** from the menu to suspend the computer.
- 3 Detach the handstrap from the computer.

### *Detach the Handstrap From a CN70 or CN70e*

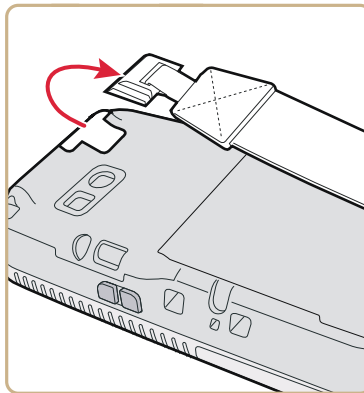

**Detach the Handstrap From a CK70 or CK71**

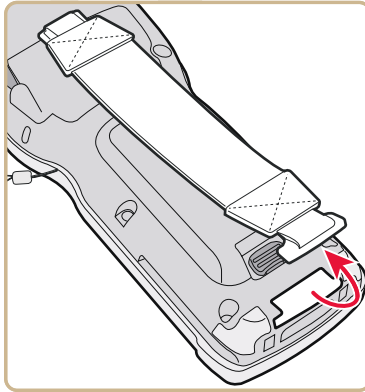

- 4** Make sure the computer is in hibernate mode and the screen is off.
- 5** Remove the battery.
  - On the CN70 or CN70e, push the battery release toward the bottom of the computer until the battery releases and then lift it away from the computer.

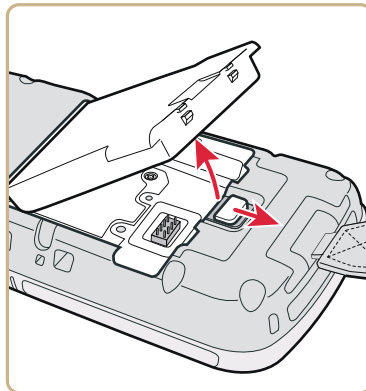

- On the CK70 or CK71, push the battery release toward the top of the computer until the battery releases and then lift it away from the computer.

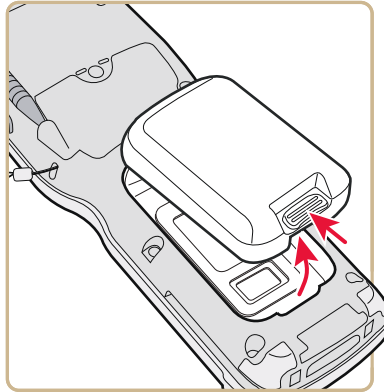



- 6 Insert the top end of a fully charged battery into the computer, and press down firmly on the bottom of the battery. Make sure that the battery release is fully engaged.

## About Battery Status

Use the battery icon on the Title bar to see the power status of your battery. If you want more detailed information on your battery such as usage time or voltage, use the Intermec Dashboard. For more information on the Dashboard, see [“About the Intermec Dashboard” on page 114](#).

### Battery Icon Status Descriptions

Battery Icon	Status
	Battery is fully charged.
	Battery has a high charge.
	Battery has a medium charge. You should be able to work for several more hours before changing batteries.
	Battery is low. You need to charge or replace the battery soon.

<b>Battery Icon</b>	<b>Status</b>
	Battery is critically low. You need to replace the battery now.
	Battery is charging.
	The battery is not installed.

You can also use the battery status LED to see the charging status of your battery.

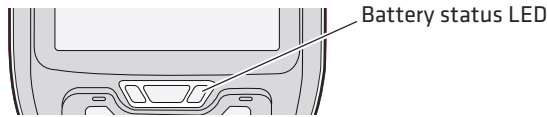

**Battery Status LED Descriptions**

<b>LED State</b>	<b>Description</b>
Steady green	The computer is connected to a charger and the battery is more than 95% charged.
Blinking red	The battery is very low. The computer will soon go into Suspend mode. Charge or replace the battery.
Steady red	The computer is connected to a charger and the battery is charging.
Blinking red-amber	The battery charging system has encountered an error. The battery is not charging.
Steady amber	The battery is outside of the allowable charging temperature range. Charging will resume when the battery temperature is back in the acceptable range of 5 °C to 35 °C (41 °F to 95 °F).
Off	The computer is not on external power and the battery is operating normally.

## About Battery Life and Conservation

Batteries that are stored outside the computer for long periods of time slowly discharge. Intermec recommends storing the battery in a charger to maintain battery performance.

### Battery Conservation Tips

When You Want To:	Do This to Save Battery Power:
Use the computer and the Low Battery status icon appears or the Battery light comes on.	<ul style="list-style-type: none"> <li>• Connect the computer to an external power source.</li> <li>• Or, save your data and press the <b>Power</b> button and select <b>Hibernate</b>. After the computer turns off, remove the battery and insert a fully charged battery.</li> </ul>
Stop using the computer for 5 minutes or longer.	Make sure that the low battery icon is not on the screen and the Battery LED is not on. Press the <b>Power</b> button and choose <b>Suspend</b> to suspend the computer.
Store the computer for more than a day.	<p>If you are storing the computer for a few days, like over the weekend, install a charged battery or connect the computer to a power source.</p> <p>If you are storing the computer for longer, remove and charge the battery, and then store both the battery and computer in a cool location. If you store the battery for several months, recharge the battery to keep it at peak performance.</p>
Store the battery outside the computer.	Store the batteries in a charger.

## About the Keypad

The CN70 comes with either a QWERTY keypad or a numeric keypad. The CN70e comes with either a QWERTY numeric keypad, a phone-style numeric keypad (1-2-3 digits across the top), or a calculator-style numeric keypad (7-8-9 digits across the top). The computer has an ambient light sensor that detects low light and turns on the keypad backlight. By default, the keypad backlight is enabled in low light conditions. You can disable the keypad backlight to conserve power. Use Intermec Settings to configure the backlight. For help, see [“Use Intermec Settings on the Computer” on page 74](#).

### **CN70 QWERTY Keypad**



**CN70 Numeric Keypad**



**CN70e QWERTY Numeric Keypad**



**CN70e Calculator-Style Numeric Keypad**



**CN70e Numeric Keypad**





The CK70 comes with either a large alpha or an alphanumeric keypad. The CK71 comes with either a numeric function keypad or an alphanumeric keypad. The computer has an ambient light sensor that detects low light and turns on the keypad backlight. By default, the keypad backlight is enabled in low light conditions. You can disable the keypad backlight to conserve power. Use Intermec Settings to configure the backlight. For help, see **“Use Intermec Settings on the Computer” on page 74.**

**CK70 Large Alpha Keypad**



**CK70 Alphanumeric Keypad**





**CK71 Numeric Function Keypad**



**CK71 Alphanumeric Keypad**



## Enter Characters on the QWERTY Keypad

You need to use the orange modifier key  and the Shift key  to access all characters and functions on the QWERTY keypad.

To type a character:

- Press the key for that character.

To type a character or access a function on the overlay:

- Press  and then press the key for the character or function.



To only type characters or access functions on the overlay:

- Press  twice to lock the orange modifier key to stay on, and then press the keys for the characters or functions.

To type a single uppercase letter:

- Press  and then the letter key.



To type all uppercase letters:

- Press   to turn on Caps Lock, and then press the letter keys.

You can still type orange modifier characters by pressing  and then the key for that character.

To turn off Caps Lock, press .

## Enter Characters on the Numeric Keypad

You need to use the orange modifier key  and the green modifier key  to access all characters and functions on the Numeric keypad.

To type a character or access a function printed in orange on the overlay:

- Press  and then press the key for the character or function.

To type a character or access a function printed in green on the overlay:

- Press  and then press the key for the character or function.

To type letters in the upper right corner of a key:

- Press  and then press the key one to three times depending on the position of the letter.

For example, in the upper right corner of the **2** key there are the letters “ABC”:

- To type “c”, press **OR** **2** **2** **2**.
- To type “C,” press **OR** **1** and then press **OR** **2** **2** **2**.



**Note:** On the calculator-style keypad, the **2** is replaced by the **8**.

To only type letters:

- Press **OR** **OR** to lock the green modifier key, and then press the key one to four times depending on the position of the letter.

While the green modifier key is locked, press **1** to toggle between only uppercase and lowercase letters.

To unlock the green modifier key, press **OR**.



**Note:** If uppercase letters are enabled and you unlock the green modifier key, you may need to press **OR** **1** to type lowercase letters.

## **Enter Characters on the CK70 and CK71 Keypads**

You need to use the orange modifier key **OR**, the green modifier key **OG**, and the Shift or Caps Lock key **SL** to access all characters and functions on the Alpha, Alphanumeric, and Numeric Function keypads.

To type a character or access a function printed in orange on the overlay or in the upper left corner of a key:

- Press **OR** and then press the key for the character or function.

To type a character or access a function printed in green on the overlay:

- Press **OG** and then press the key for the character or function.

To type a single uppercase letter:

- Press **SL** and then the letter key.

To type all uppercase letters:

- Press **SL** **SL** to turn on Caps Lock, and then press the letter keys.

You can still type orange or green modifier characters by pressing **OR** or **OG** and then the key for that character.

To turn off Caps Lock, press **SL**.

## About the Power Button

When you press the **Power** button, a dialog box with a list of power options appears. If you do not select a power options setting, the currently selected action (the button outlined in bold) occurs after the timeout.

### *The Intermec Power Options Default Screen*

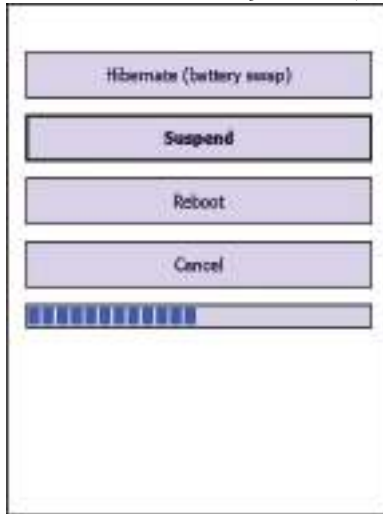

**Note:** The Real Time Clock (RTC) persists through all of the power options as long as it receives power from the Real Time Clock battery.

### *Intermec Power Options*

Option	Description
Hibernate (battery swap)	High power saving mode. Use this setting only for swapping the battery. The computer saves the current system state, registry, and file system and then powers off all radios and internal devices. You can wake the computer by pressing the <b>Power</b> button or connecting the computer to external power.

Option	Description
Suspend	Medium power saving mode. The computer powers off all radios and internal devices not involved in saving the system state, but the phone stays on to receive calls. This option is the default setting. You can wake the computer by pressing the <b>Power</b> button, pulling the scanner trigger, receiving a call, scheduling an event such as an alarm, or by connecting external power.
Reboot	The computer does not save the current system state, but the registry and file systems are saved. The computer shuts down all running processes and restarts.
Cancel	The Power Options menu is cancelled.
Screen Off	Lowest power saving mode. The screen turns off, but the phone, all radios, and internal devices stay on. Tap the screen to turn the screen back on.
Shutdown	Very high power saving mode. The computer turns off everything. You must press <b>Power</b> or apply external power to restart the computer.

The Intermec Power Options screen is customizable. You can use Intermec Settings to determine which options are available to end users, the timeout until the default choice is selected, the default action if no option is selected, or to disable the Power Options screen. For more information on customizing the screen using Intermec Settings, see [“Use Intermec Settings on the Computer” on page 74](#) or see the *Intermec Settings Command Reference Manual*.

## About the Intermec Dashboard Button

If the Ready-to-Work light blinks, your computer may be experiencing a problem. Press the Intermec Dashboard button (🔍) to launch the Intermec Dashboard application and view troubleshooting and status information.

You can press the 🔍 button at any time to bring up the Intermec Dashboard. If the computer is not healthy, the current issues are displayed at the top of the screen. If the device is healthy, you can use the Dashboard to view device information. For more information, see [“About the Intermec Dashboard” on page 114](#).



## Configure the Screen Backlight

The display has an ambient light sensor that automatically adjusts the backlight intensity to conserve power and ensure the display is readable.

By default, the screen turns off when there is no activity with the computer. Press a key or tap the screen to resume activity.

You can configure the screen backlight to turn off.

- 1 Tap **Start > Settings > Power**.
- 2 Tap **Advanced** on the horizontal scroll bar.
- 3 Select the screen power off settings for when the computer is on battery power or external power.

## Configure the Screen Brightness

You can configure the screen brightness using Intermec Settings or from the Start menu.

- 1 Tap **Start > Settings > System > Backlight**.
- 2 Adjust the slider to the desired brightness level.
- 3 Tap **OK**.



## Adjust the Volume

You can adjust the computer volume for your needs and your environment. The volume includes sounds you hear when you tap the screen or read bar codes with the imager. You can set the volume to off, very low, low, medium, high, very high (default), or vibrate.

You can also use the buttons on the right side of the computer to adjust the volume:

- The upper button increases the volume.
- The lower button decreases the volume.

You can adjust the volume settings using Intermec Settings or the horizontal scroll menu.

- 1 Tap the Volume icon at the top of the screen, and then tap the volume icon on the horizontal scroll menu.
- 2 Use your stylus or the  and  keys to adjust the volume slider to the volume you want, select **Vibrate**, or select **Off**.

## About the Imager

The computer ships with an internal imager. You can use the imager as a flashlight or to read bar codes.



**Note:** When the Pictures & Videos application is running, you cannot use the imager.

## Use the Imager as a Flashlight

You can use the EA30 imager as a flashlight. By default, the imager is set to read bar codes. To use the imager as a flashlight, you must remap the Left side lower button.

- 1 Open Intermec Settings on the mobile computer by tapping **Start > Settings > System > Intermec Settings**.
- 2 From the Intermec Settings main menu, tap **Device Settings > Keypad**.
- 3 From the Keypad menu, tap **Button Remapping**.
- 4 From the **Left side lower button** menu, select **Flashlight**.
- 5 From the **Flashlight timeout** drop-down menu, select how long to leave the flashlight on before it automatically turns off.
- 6 Tap **OK**.

# Read Bar Codes

Depending on the imager model in your computer, you can read 1D and 2D bar code symbologies, composite symbologies, and postal codes.

You can also connect the computer to cordless scanners (like the SF51 and SR61) through Bluetooth communications or tethered scanners (like the SR30 and SR61T) through the RS-232 adapter. For help, see **“Connect to a Bluetooth Scanner” on page 85** and **“Connect to a Tethered Scanner” on page 89**, respectively.

- 1 Enable only the bar code symbologies that you need.
- 2 Use Intermec Settings to select the predefined imager mode that best suits your environment:

Predefined Mode	For Scanning
1D	Only 1D labels.
1D and 2D Standard	(Default) All types of bar code labels.
1D and 2D Bright Environment	In high ambient light, such as outdoors in the sunshine.
1D and 2D Reflective Surface	Glossy labels.



**Note:** You can also select the imager predefined mode in Profile Settings by tapping **Start > Profile Settings > Scanning**.

- 3 Point the imager window at the bar code label, and hold the computer steady a few inches from the label.
- 4 Press the **Scan** button. The laser pointer and illumination beam or frame appear.

### Scanning With the EA30 Imager

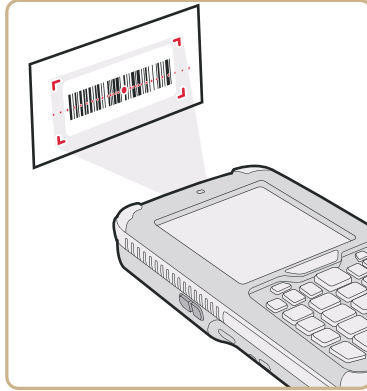

- 5 Use the laser pointer as a guide and aim toward the middle of the bar code. Make sure that the illumination beam or frame covers the bar code you are trying to decode.

When the computer successfully reads a bar code label, you hear a high beep, and the Good Read LED turns on briefly.

- 6 Release the **Scan** button.

## Insert a microSD Card

You can use a microSD™ card to increase file storage and install software. The computers support an optional 32 GB maximum capacity microSD card.



**Note:** The computer resets when you open the card access door to insert the microSD card. Make sure you completely close the card access door before you use your computer.

## Install a microSD Card in a CN70 or CN70e

You need a Phillips screwdriver to install the microSD card.

- 1 Press the Power button to turn off the computer.
- 2 Remove the handstrap and the battery.

- 3** Remove the two Phillips screws and open the card access door.

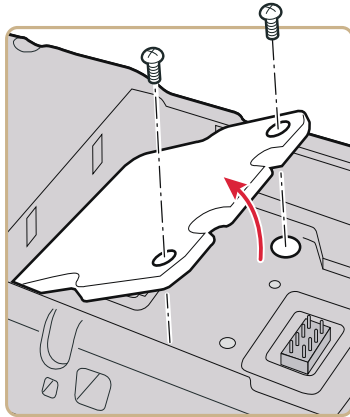

- 4** Slide the SIM card door to the left to unlock it and open the door.

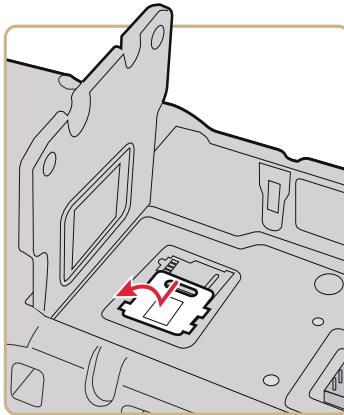

## Chapter 1 – About the Computer Features

- 5 Slide the microSD card door towards the top of the computer to unlock it and open the door.

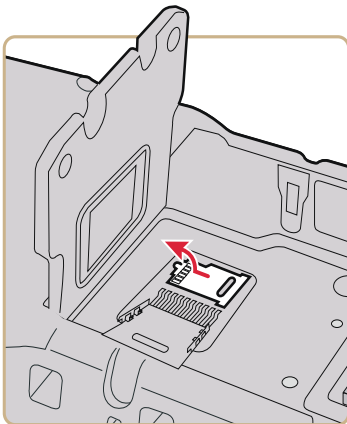

- 6 Slide the microSD card into place.

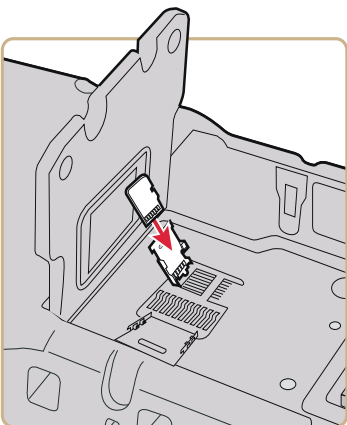

- 7 Close the microSD card door and slide it towards the bottom of the computer to lock it in place.
- 8 Close the SIM card door and slide it to the right to lock it in place.
- 9 Close the card access door and replace the two screws.
- 10 Install the battery. Press down firmly on the bottom of the battery, and make sure that the battery release tab is fully engaged.

- 11** Attach the handstrap.
- 12** Press the **Power** button. The computer cold boots.

## **Install a MicroSD Card in a CK70 or CK71**

You need a Phillips screwdriver to install the microSD card.

- 1** Press the **Power** button to turn off the computer.
- 2** Remove the handstrap.
- 3** Remove the two screws that attach the interface adapter cover to the back of the computer.

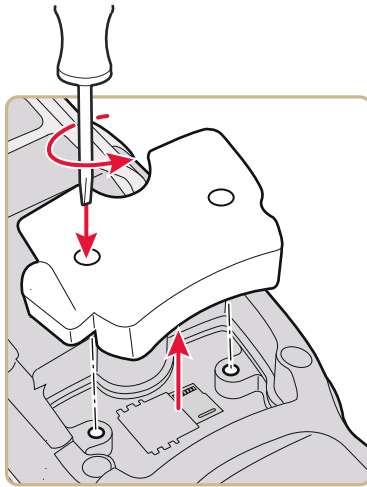

## Chapter 1 – About the Computer Features

- 4 Slide the SIM card door to the left to unlock it and open the door.

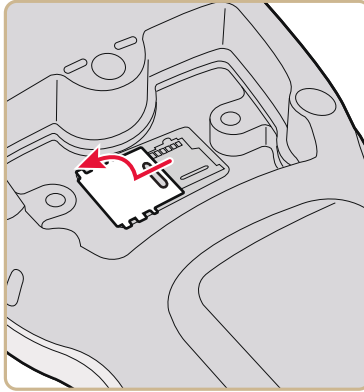

- 5 Slide the microSD card door towards the top of the computer to unlock it and open the door.

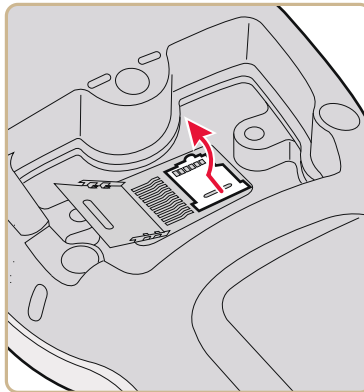



- 6 Slide the microSD card into place.

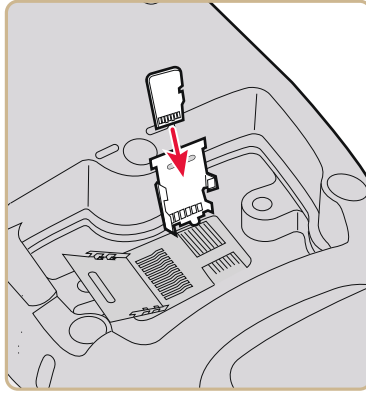

- 7 Close the microSD card door and slide it towards the bottom of the computer to lock it in place.
- 8 Close the SIM card door and slide it to the right to lock it in place.
- 9 Replace the interface adapter cover and attach with the two screws removed in Step 2.
- 10 Install the battery. Press down firmly on the bottom of the battery, and make sure that the battery release tab is fully engaged.
- 11 Reattach the handstrap.
- 12 Press the **Power** button. The computer cold boots.

## **Transfer Files To and From Your PC**

The 70 Series computer supports these two methods for transferring files to and from your PC:

- Using Microsoft ActiveSync or Windows Mobile Device Center.
- Using the 70 Series computer as a mass storage device.

## Use Microsoft ActiveSync to Transfer Files

You can use Microsoft ActiveSync (Windows XP or earlier) or Windows Mobile Device Center (Windows Vista or Windows 7) to establish a connection between your computer and a PC. After you connect to your PC, you can transfer files, synchronize files, remotely debug, and perform other device management activities. ActiveSync and Windows Mobile Device Center are free applications available from the Microsoft website at [www.windowsmobile.com/getstarted](http://www.windowsmobile.com/getstarted).

To establish a partnership between your computer and a PC, you need to physically connect your computer to your PC using these accessories:

- USB snap-on adapter (Model 1000AA07)
- USB cable

Using these accessories, you can transfer files to and from your PC using ActiveSync.

- 1 Connect your mobile computer to your desktop PC using the adapter and USB cable.
- 2 Download ActiveSync from the Microsoft website and install ActiveSync on your PC.
- 3 Follow the onscreen instructions to establish a partnership. When the partnership is established, the Microsoft ActiveSync screen appears on your PC.



## **Use the Computer as a Mass Storage Device**

You can connect the 70 Series computer as a mass storage device to your desktop PC. When connected as a mass storage device, you can easily copy files to and from the mobile computer.

- 1** Go to [www.datalight.com](http://www.datalight.com) and download the Reliance Nitro Windows Driver (RNWD). You need to login before you can download the driver.
- 2** Connect the mobile computer to your desktop PC using a USB cable.
- 3** On the mobile computer, tap **Start > Settings > System > Intermec Settings**.
- 4** From the Intermec Settings Main Menu, tap **Device Settings > USB**.
- 5** From the USB function driver menu, select **Mass storage - Flash File Store** and tap **OK**.
- 6** Copy files to and from your desktop PC to the mobile computer.



# 2

## About the User Interface and Intermec Applications

Use this chapter to learn about the Windows Embedded Handheld user interface and how to interact with the screen. You can also use this chapter to learn about the Intermec applications on your computer, as well as additional Intermec applications you can download.

## About the User Interface

The user interface for the Windows Embedded Handheld 6.5 operating system is different from previous versions of Windows Mobile. The interface is touch-friendly and easy to navigate. Use the following sections to understand how to interact with Windows Embedded Handheld 6.5.

### About the Home Screen

When you turn on your mobile computer, the Home screen is the first screen that appears. The Home screen contains three navigation bars: the Title bar, the horizontal scroll bar, and the Tile bar.

#### **The Windows Embedded Handheld 6.5 Home Screen**

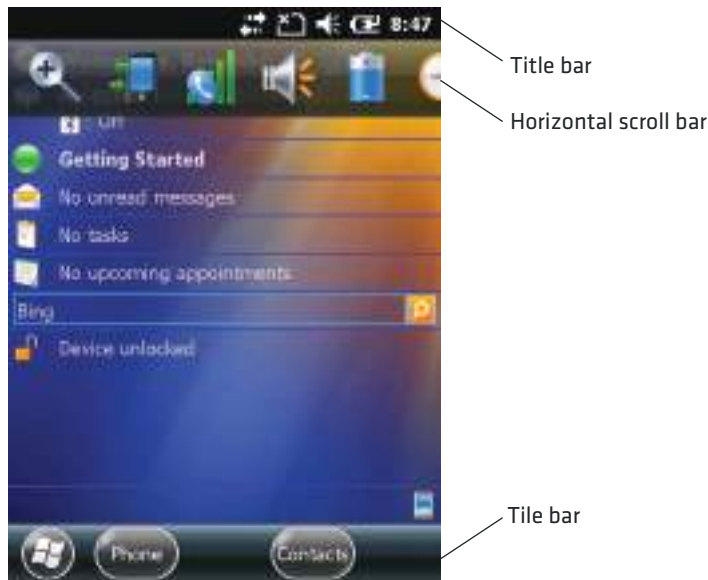

Use the Title bar icons to view the current status of information such as signal strength and battery power remaining. For more information on the Title bar icons, see **“Title Bar Status Icons” on page 42**.

A horizontal scroll bar appears when you tap an icon in the Title bar. This horizontal scroll bar makes it easy to access the applications associated with the Tile bar icons. The horizontal scroll bar also contains a magnifier which improves the touch experience by making parts of the screen large enough to tap with your finger.

The horizontal scroll bar also replaces tabs within Windows screens and allows for easier navigation.

***Clock & Alarms Screen With Horizontal Scroll Bar***



Use the Tile bar to navigate between screens and within applications. The icons available on the Tile bar change depending on the application you are using.

## **Interact with the Screen**

The Windows Embedded Handheld 6.5 interface supports the use of gestures with the finger or stylus to move around the screen. The table below explains the supported gestures.

<b>Gesture</b>	<b>Description</b>
Tap	Represents the left click of a mouse.
Double-tap	Represents the left double-click of a mouse.
Hold	Represents the right click of a mouse when you press and hold on the screen and a context menu appears.
Flick	Initiates scrolling in the direction (horizontal or vertical) the finger or stylus moves across the screen.
Pan	Press and hold on the screen and then drag in any direction.



















## Title Bar Status Icons



















Tappable icons in the Title bar immediately show you the status of your network, your phone, the volume, the battery, and the time. Use the following table to understand what the icons mean.









### ***Title Bar Status Icon Descriptions***

<b>Icon</b>	<b>Description</b>
	You have a new notification.
	You have a new text message.
	You have a new email message.
	You have a new instant message.
	You missed a call.
	The speakerphone is on.
	The phone is roaming.
	An alarm is set.
	The microphone is on.
	An internet call is in progress.
	A Bluetooth headset is detected.
	An ActiveSync connection has been established.
	There is a problem with the ActiveSync synchronization.
	An ActiveSync synchronization is in progress over USB.
	A CDMA connection is active.
	A CDMA connection is available, but not transferring data.



<b>Icon</b>	<b>Description</b>
	A UMTS network is available.
	Connecting to a UMTS network.
	A UMTS connection is active.
	A 3G+ network is available.
	An EDGE network is available.
	Connecting to an EDGE network.
	An EDGE connection is active.
	A GPRS network is available.
	Connecting to a GPRS network.
	A GPRS connection is active.
	An HSDPA network is available.
	Connecting to an HSDPA network.
	An HSDPA connection is active.
	Bluetooth is on.
	Wi-Fi is on but not connected, and no networks are detected.
	Wi-Fi is not connected to a network, and other networks are detected.
	Other wireless networks are detected.
	Connected to a wireless network.
	Synchronizing through a Wi-Fi connection.

Icon	Description
	Connected to a wireless network, and other networks are detected.
	Information about a new wireless network is available.
	A network connection is active.
	A network connection is inactive.
	The phone has maximum signal strength.
	The phone has no signal.
	The phone capability is off.
	The phone has no service.
	The phone is searching for service.
	Data is being transferred.
	A voice call is in progress.
	A voice call is on hold.
	There is no SIM card present in the computer.
	The volume is off and the phone is set to vibrate.
	The volume is on.
	The volume is off.
	The battery has a full charge.
	The battery has a high charge.
	The battery has a medium charge.

<b>Icon</b>	<b>Description</b>
	The battery has a low charge.
	The battery has a very low charge.
	The battery is attached to external power and is charging.
	No battery is installed in the computer.
	Call forwarding is on.
	Voice mail is off.
	GPS locator is off.
	GPS locator is on.

## **Align the Screen**

You may need to align your screen if you tap on one area and it registers in a different part of the screen. Make sure you only use the stylus to complete the alignment process.

- 1** Tap **Start** (⊞) > **Settings** > **System** > **Screen**.
- 2** Follow the prompts on the screen to complete the alignment process.







## **About Intermec Applications**





Intermec provides many useful applications to help you configure, troubleshoot, and connect your computer to other devices and networks. You can also download additional applications from the Intermec website to help you use all of the features of your computer.

### **Applications Available on the Mobile Computer**

Use this table to understand some of the Intermec applications available on your computer.

**Intermec Applications Available on the Mobile Computer**

Icon	Application	Description
	Bluetooth Audio	Use the Bluetooth Audio application to connect to a Bluetooth headset or hands-free device. For more information, see <b>“Connect to a Bluetooth Audio Device” on page 88.</b>
	Carrier Selection	Use the Carrier Selection application to quickly change your network carrier. For more information, see <b>“About Network Carriers” on page 56.</b>
	CloneNGo	Use CloneNGo to configure basic device settings on multiple client computers from one master computer. For more information, see <b>“Manage the Computer Using CloneNGo” on page 106.</b>
	iGPS	Use the iGPS application to improve the performance of GPS on your computer. For more information, see <b>“Improve GPS Performance on the Computer” on page 72.</b> iGPS is only available on computers with phone capability.
	Intermec Settings	Use Intermec Settings to configure your computer. You can use Intermec Settings to individually configure a computer or you can use it through SmartSystems to configure all of your computers. For more information, see <b>“Use Intermec Settings on the Computer” on page 74.</b>
	ISpyWiFi	Use ISpyWiFi to check your 802.11 status and diagnose issues with the connection. For more information, see <b>“Check 802.11 Network Status” on page 117.</b>
	Profile Settings	Use Profile Settings to easily configure the computer for a specific use. You can choose predefined values for the Camera, Power, and Scanning. <ul style="list-style-type: none"> <li>• Tap the Profile Setting you want to use. You will see a message that changes are saved and a check mark appears next to your choice. For more information on modifying Profile Settings options, see <b>“Configure Profile Settings with Intermec Settings” on page 80.</b></li> </ul>

Icon	Application	Description
	ScanDiagnostic	Use the ScanDiagnostic application to troubleshoot problems with the internal or external scanner. For more information, see “ <a href="#">Use ScanDiagnostic to Troubleshoot the Scanner</a> ” on page 120.
	SceneEditor	Use the SceneEditor application to modify predefined camera scenes or create new scenes. For more information, see “ <a href="#">Configure Camera Scenes</a> ” on page 65.
	Wireless Center	Use the Wireless Center to turn radios (Wi-Fi, Bluetooth, phone) on and off and configure settings for each radio.
	Wireless Printing	Use the Wireless Printing application to connect to a Bluetooth printer. For more information, see “ <a href="#">Connect to a Bluetooth Printer</a> ” on page 87.
	Wireless Scanning	Use the Wireless Scanning application to connect to a Bluetooth scanner. For more information, see “ <a href="#">Connect to a Bluetooth Scanner</a> ” on page 85.

## Applications You Can Download to the Mobile Computer

You can download several Intermec applications from the website that extend the capabilities of your 70 Series computer. All of the applications listed below are available from the Intermec website. Some of the applications require the purchase of a license to run. To find the application you want, go to [www.intermec.com](http://www.intermec.com) > **Support** > **Downloads** and then enter the information to find your 70 Series computer.

### About eMDI

Intermec Enhanced Mobile Document Imaging Application (eMDI) is a professional document capture application that enables you to capture images of full page documents (8.5 x 11 or A4 paper sizes) with the camera. You can transfer the images from your mobile computer to a PC or server. For more information, see the *[Intermec Enhanced Mobile Document Imaging User Guide](#)*. You can download and use eMDI for a 30-day evaluation period. After the evaluation period expires, you will need to purchase a license.

## **About Features Demo**

Intermec Features Demo provides a simple way to explore the key features of your mobile computer. You will find applications that demonstrate scanning, document imaging, image capture, printing, and GPS functionality. Many of the applications that are part of Features Demo also have separate full-featured versions that you can download and license for your computer.

## **About Image Capture**

The Intermec Image Capture application is provided for use on the 70 Series computers with an EA30 imager. Image capture provides a way for users to capture a high quality grayscale image with a mobile computer. Image Capture also allows you to change settings to provide the best image possible for the conditions present. You do not need to license Image Capture.

## **About Intermec Browser**

Intermec Browser is a locked-down web application for your computer that is compatible with Internet Explorer 6.0. You can configure Intermec Browser for your specific application requirements and design your own web pages. You can download and use Intermec Browser for a 60-day evaluation period. After the evaluation period expires, you will need to purchase a license.

## **About Intermec Connection Manager**

Intermec Connection Manager is a software application and API interface that provides seamless network roaming for Intermec mobile computers configured with one or more wired or wireless technologies (Ethernet, 802.11, GPRS, CDMA). Intermec Connection Manager works in the background to automatically establish and maintain connections. You can download and use Intermec Connection Manager for a 60-day evaluation period. the evaluation period expires, you will need to purchase a license.

## **About Intermec Launcher**

Intermec Launcher is a Microsoft Windows application, designed for Intermec mobile computers, that provides a platform from which other applications may be launched while attempting to provide a locked-down environment. You can configure Intermec Launcher for your specific application requirements. You can download and use Intermec Launcher for a 60-day evaluation period. After the evaluation period expires, you will need to purchase a license.

## **About Intermec Terminal Emulator (ITE)**

Intermec Terminal Emulator (ITE), part of Intermec Client Pack (ICP), is the next generation of Intermec's popular terminal emulation client designed for enterprise-level data collection. It provides a consistent user interface and a common menu structure to simplify the use and management of applications running on Intermec mobile and wireless computers.

ITE is packed with enhancements that improve productivity, reduce errors, and deliver fast return on investment. It supports multiple emulation protocols in a single client and has new features such as session persistence, remote management and configuration, and offers a maintenance plan to keep you up-to-date with the latest releases and upgrades. You can download and use ITE for a 60-day evaluation period. After the evaluation period expires, you will need to purchase a license and maintenance plan.

## **About SmartSystems**

SmartSystems™ is an easy-to-use software platform that provides IT Administrators and Integrators a single, integrated portal for hands-free provisioning, deployment, and management of Intermec devices minimizing the effort spent on software upgrades, equipment monitoring, maintenance and troubleshooting.

SmartSystems provides a consistent way to manage Intermec devices including mobile computers, RFID readers, printers and bar code scanners, located on-site or remote, to make the most of limited IT resources, and lower the total cost of ownership for Intermec data collection equipment. SmartSystems can be downloaded at no charge from the Intermec website. For more information, visit [www.intermec.com/SmartSystems](http://www.intermec.com/SmartSystems).





# 3

## Use the Phone

You can use the phone feature to make and receive telephone calls, as well as transmit data through cellular wide-area networks (WANs).

## About the Phone

The 70 Series mobile computer supports two types of cellular technology:

- CDMA
- UMTS



**Note:** Your Flexible Network Radio mobile computer supports both CDMA and UMTS technology. Your Flexible Network Radio does not support Network Information and Time Zone (NITZ) messages to automatically set the system time.

Phone features on the computer include a speaker and a microphone. You can also use a Bluetooth headset or hands-free kit. The phone feature is enabled by default on WWAN-equipped mobile computers.

After you turn on the phone and activate service with your wireless carrier, you can customize the phone features and network settings. For more information, see the online help on your mobile computer.

## Activate the UMTS Phone

You use a SIM card to activate the UMTS phone on your computer. You can purchase the SIM card from your network provider.

- 1 Press the **Power** button to turn off the computer.

- 2** On the CN70 or CN70e:
  - a** Push the battery release tab forward until the battery releases, and lift the battery away from the computer.
  - b** Remove the two Phillips screws and open the card access door.

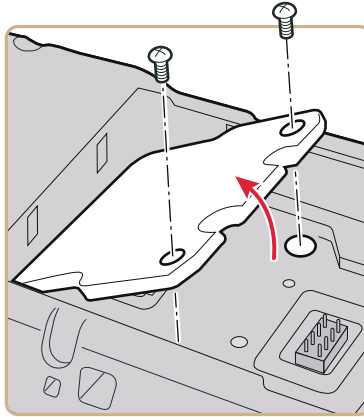

- 3** On the CK70, remove the two screws and lift the card access door away from the computer.

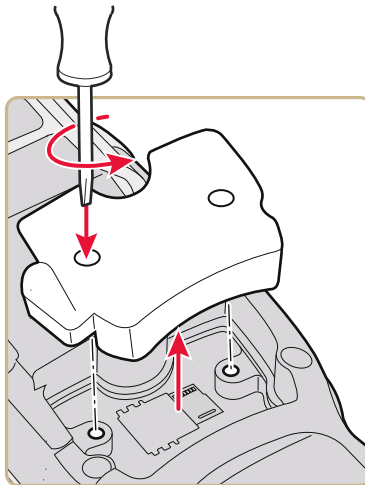

- 4** Slide the SIM card door to the left to unlock it and open the door.

- 5 Slide the SIM card into the slot in the card access door.

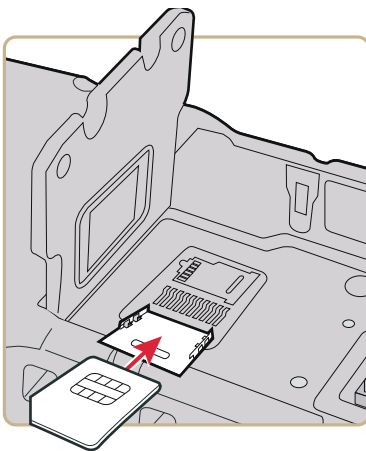

- 6 Close the SIM card door and slide it to the right to lock it in place.
- 7 Close the card access door and replace the two screws.
- 8 Install the battery. Press down firmly on the bottom of the battery, and make sure that the battery release tab is fully engaged.
- 9 Press the **Power** button. The computer cold boots.

## Activate the CDMA Phone

To activate the CDMA radio module in your mobile computer, you need to contact your wireless carrier and set up an account for each mobile computer. The following table lists the carriers that Intermec currently supports. If your carrier is not listed in the table, please contact Intermec product support to see if it is now supported.

### **Currently Supported Carriers**

Country	Carriers
United States	Sprint, Verizon

The carrier requires the Mobile Equipment Identifier (MEID) to start the activation process. You can find the MEID:

- on a label located in the upper right corner of the battery compartment.
- on the outside of the computer shipping box.
- in the Version Information menu. Tap **Start > Settings > Personal > Phone > Version Information** tab.

The activation process is slightly different for each CDMA carrier. Your carrier sales contact and an Intermec representative can guide you through the process.

After you supply the MEID to your carrier, they will respond with values that you must enter using the Windows Mobile Activation Wizard (if required). Some of the supported carriers do not require you to enter any values. The following table shows the carriers, the correct activation method to use, and the values that you need to activate your phone.

**Values Required for CDMA Phone**

<b>Carrier</b>	<b>Activation Method</b>	<b>Activation Values You Need</b>
Sprint	Activation Wizard	<ul style="list-style-type: none"> <li>• Master Subsidy Lock (MSL) or activation code</li> <li>• MDN</li> <li>• MEID</li> </ul>
Verizon	<ul style="list-style-type: none"> <li>• Dial *22899</li> <li>• Activation Wizard</li> </ul>	None. All parameters are automatically transferred wirelessly.

After activation, the settings are permanently stored in the CDMA module. Changing the OS loads will not affect any of the settings or activation parameters stored in the WAN modem.

## **Start the Activation Wizard**

Depending on your wireless carrier, you may need to use the Windows Mobile Activation Wizard to activate your phone.

- 1** Tap **Start > Phone**, or tap the **Phone** button on the Tile bar.  
The phone application starts.
- 2** Tap **Menu > Activation Wizard**.

## **Turn the Phone On and Off**

Before you can start using your phone, you need to enable it. You can use Wireless Center to enable and disable your phone, as well as Bluetooth and Wi-Fi communications.

- 1** Tap **Start > Settings > Connections > Wireless Center**.
- 2** Tap **Phone** to turn on the Phone
- 3** (Optional) To configure the phone, tap **Menu** in the tile bar at the bottom of the screen.
- 4** Tap **OK** when you are done configuring the options.
- 5** Tap **OK** to close Wireless Center.

## **About Network Carriers**

Your Flexible Network Radio-enabled CN70, CN70e, or CK70 mobile computer contains a highly configurable WWAN platform. When you switch network carriers, or perform a clean boot, the cellular network connection is automatically configured.

# Switch Network Carriers

Use the Carrier Selection application to quickly change your WWAN radio network carrier on your Flexible Network Radio-enabled CN70, CN70e, or CK70 mobile computer.

- 1 Tap **Start > Settings > Personal > Carrier Selection**.

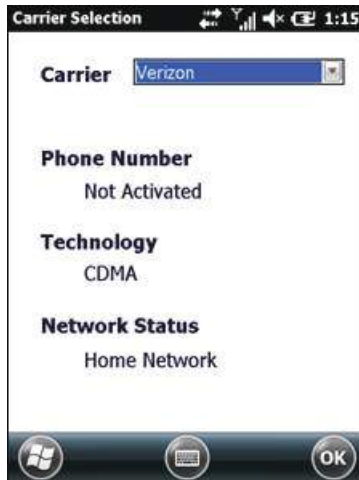

- 2 Select a **Carrier** and tap **OK**. A dialog box appears asking if you want to switch carriers.
- 3 Tap **Yes** to switch carriers.

If the update is successful, the Carrier Selection screen appears and displays the updated carrier information.

If the update is unsuccessful, a message box appears. Tap **Ok** to return to the Carrier Selection screen.

## Add the WWAN Connection

If you are switching to a CDMA network, or switching from a CDMA network to a UMTS network, you must add the WWAN connection in Intermec Settings.

- 1 Tap **Start > Settings > System > Intermec Settings > Communications > WWAN Radio**.
- 2 Select **Add New WWAN Connection**.
- 3 Enter a **Connection Name**. In the Phone Number field, enter **#777** and tap **OK**. The Manage WWAN Radio State screen appears.





- 4 From Active Connection, select your **Connection Name** and **Connect Now** and tap **OK**.



## About the Network Connection



**Note:** When you perform a clean boot, the selected carrier will default to generic UMTS.

When you perform a clean boot, all user-created network connection entries are deleted, and only the generic UMTS remains. After you perform a clean boot, you can find more information about generic UMTS by tapping **Start** > **Settings** > **Connections** > **Connections** > **Tasks** tab > **Manage Existing Connections** > **Modem** tab.

## Make a Phone Call

After you activate your UTM or CDMA phone, you are ready to start making phone calls.



**Note:** Your Flexible Network Radio mobile computer is data only. You cannot make phone calls from the Flexible Network Radio.

- 1 Press **Phone**.
- 2 Tap the keys to enter the telephone number you want to call, and tap **Talk**.

## Make an Emergency Phone Call

You can use the UMTS phone to make an emergency phone call even if the SIM card is missing. When the SIM card is not installed, the phone will show that you have no service. However, if you dial certain emergency numbers (such as 112, 911, 000, 08, 118, 119, and 999) the call will go through.



**Note:** Your Flexible Network Radio mobile computer is data only. You cannot make phone calls from the Flexible Network Radio.

# 4

## Use the Camera

You can use the color camera to take pictures and record videos.

## About the Color Camera

The camera and flash are located on the back of the computer. You run the Pictures & Videos application to access the camera features.



**Note:** While the Pictures & Videos application is running, you cannot use the imager.

In the Pictures & Videos application, you can:

- configure camera settings.
- take, view, and edit pictures.
- switch between Still (camera) mode and Video mode.
- record and launch video clips stored on the computer or a microSD card.

You can send pictures and video clips to others or save an image as the background on the Home screen. If you download the eMDI application, it uses the camera to capture images.

## About the Camera Settings

You can configure camera settings to meet the needs of your operating environment:

- Basic camera settings are available from the main menu of the Pictures & Videos application.
- Advanced camera settings are available from the Settings menu option from the main menu of the Pictures & Videos application.

### **Basic Camera Settings**

Setting	Description
Mode	Determines the camera operating mode: <ul style="list-style-type: none"><li>• Normal: Takes one picture.</li><li>• Burst: Takes a series of three pictures.</li><li>• Timer: Waits 10 seconds before taking the picture.</li></ul>
Resolution	Determines the resolution of the image. You can select values for image resolution or screen resolution.
Zoom	Determines the amount of zoom: from 1x to 4x.

<b>Setting</b>	<b>Description</b>
Scenes	<p>Predefined scenes that optimize the camera settings for a specific environment:</p> <ul style="list-style-type: none"> <li>• DocCap: Intermec document capture.</li> <li>• Check: Capture images of paper checks.</li> <li>• Night: Low light conditions.</li> <li>• Cloudy: Cloudy or overcast conditions.</li> <li>• Daylight: Bright sun.</li> <li>• Van Interior: Dimly lit vehicle interior.</li> <li>• Warehouse: Warehouse environment.</li> <li>• Office Store: Office or store environment.</li> <li>• Manual: Manually configure a specific set of camera settings.</li> <li>• Auto: The camera automatically configures the settings.</li> </ul>
Settings	Advanced camera settings that you can configure. See the next table, <b>“Advanced Camera Settings”</b> .
Torch	The state of the camera flash depending on the lighting conditions: on, off, or automatic.
Flash	The state of the camera flash when you take a picture: on, off, or automatic.
Focus	Determines if the focus is continuous, single shot, or manual. If you select manual focus, you need to set the Focus Distance.
Focus Distance	The distance at which the camera focuses. Values are 2.5 in, 4.5 in, 7.5 in, 1-3 ft, 3-9 ft, and Infinity (focuses the lens so that an infinitely distant object would be in focus).

### **Advanced Camera Settings**

<b>Setting</b>	<b>Description</b>
Exposure Metering	<p>The area of the image the camera uses to determine optimal exposure:</p> <ul style="list-style-type: none"> <li>• Whole Avg.: Uses the image as a whole.</li> <li>• Whole Center Weight: Uses the entire image but places emphasis on the center quarter of the image.</li> <li>• Center 1/4 Avg.: Uses the center quarter of the image.</li> <li>• Lower 1/4 Avg.: Uses the lower quarter of the image.</li> <li>• Upper 1/4 Avg.: Uses the upper quarter of the image.</li> <li>• Lower 1/2 Avg.: Uses the lower half of the image.</li> <li>• Upper 1/2 Avg.: Uses the upper half of the image.</li> </ul> <p>Default is Center 1/4 Avg.</p>

<b>Setting</b>	<b>Description</b>
Exposure	Exposure level of the image. Values are from -2.5 (darker, underexposed) to +2.5 (lighter, overexposed) in increments of 0.5. Default is 0.
Brightness	Brightness level of the image. Manual settings are from -4 (very dark) to +4 (very light) in increments of 1. Default is Auto.
Contrast	Amount of contrast in the image. Manual settings are from -4 (least contrast) to +4 (most contrast) in increments of 1. Default is Auto.
Saturation	Color saturation level. Manual settings are from -4 (black and white) to +4 (maximum color) in increments of 1. Default is Auto.
Sharpness	Sharpness of the image. Manual settings are from -4 (very soft) to +4 (very sharp) in increments of 1. Default is Auto.
White Balance	Compensates for specific lighting conditions to produce true color images: <ul style="list-style-type: none"><li>• Auto: Automatic White Balance (AWB) control.</li><li>• Sunny: Outdoors in bright, midday sunny conditions.</li><li>• Cloudy: Outdoors with a completely overcast cloudy sky.</li><li>• Tungsten: Indoors lit with tungsten light bulbs.</li><li>• Office: Indoors lit with fluorescent light bulbs.</li></ul> Default is Auto.
Flash Profile	Controls the amount of flash for a specific condition: <ul style="list-style-type: none"><li>• 0: This profile is reserved.</li><li>• 1: Document imaging in light to moderately light ambient conditions.</li><li>• 2: Dark, semi-reflective environments, such as a vehicle interior or dimly lit room.</li><li>• 3: Dark, non-reflective large or outdoor environments. Provides very long flash durations.</li><li>• 4: This profile is reserved.</li></ul> Default is 1.
DeNoise	Controls the amount of noise, or graininess, in the image: <ul style="list-style-type: none"><li>• Disabled: Disable noise reduction.</li><li>• Normal: Use normal noise reduction.</li><li>• Enhanced: Enhance the noise reduction.</li></ul>

## Configure the Camera

Use the Pictures & Videos application to configure the camera.



**Note:** You can also use Intermec Settings to configure some camera options.

- 1 Tap **Start** > **Pictures & Video**.
- 2 To enter Still mode, tap the **Camera** icon in the grid or the **Camera** button on the Tile bar.
- 3 Tap **Menu**.
- 4 Select a setting to configure.

## Configure Camera Scenes

You can modify predefined camera scenes or create new scenes to further accommodate your specific needs.

- 1 Tap **Start** > **SceneEditor**.
- 2 Select a **Scene** to configure.  
Or, to create a new scene, tap **New**.
- 3 Configure the necessary settings.  
If you are creating a new scene, type a name in the **Scene** box.
- 4 Tap **Save**.
- 5 When you are prompted to save the settings, tap **Yes**.  
The changes you made are saved.
- 6 Tap **ok** to close the message box.

## Take a Picture

When you take a picture, the image is saved as a .jpg file and stored in the /My Documents/My Pictures folder.

- 1 Tap **Start > Pictures & Videos**.
- 2 Tap the **Camera** icon in the grid or the **Camera** button on the Tile bar, or press **Enter**.
- 3 Using the screen as a viewfinder, move the camera until you have the image you want to take a picture of.
- 4 Hold the camera as still as possible, and press **Enter** to take and save the picture.

If you choose to save your pictures to Main memory, they are saved to permanent storage on your mobile computer.

## Record a Video

You need to switch to video mode to record video. When you record video, the video is saved as an .mp4 file and stored in the /My Documents/My Pictures folder.

- 1 Tap **Start > Pictures & Videos**.
- 2 Tap the **Camera** icon in the grid or the **Camera** button on the Tile bar, or press **Enter**.
- 3 Tap **Menu > Video**.
- 4 Using the screen as a viewfinder, move the video camera until you see the scene you want to video record.
- 5 Press **Enter** to start recording.
- 6 When you are done, tap **Stop** or press **Enter** to stop recording and save the video.

If you choose to save your videos to Main memory, they are saved to permanent storage on the computer.



## Save Pictures and Videos to a microSD Card

Pictures and videos are automatically saved to the main memory on your computer. You can save your pictures and video to a microSD card to easily transport them to another device.

- 1 Install a microSD card. For help, see “[Insert a MicroSD Card](#)” on [page 30](#).
- 2 Tap **Start** > **Pictures & Videos**.
- 3 Tap the camera icon.
- 4 Tap **Menu** > **Options**.
- 5 From the **Save files to** list, select **SD card**, and tap **OK**.



# 5

## Use GPS

The 70 Series computer comes equipped with an integrated Global Positioning System (GPS) receiver if your computer has phone capability (WWAN radio). The GPS receiver can deliver standards-based National Marine Electronics Association (NMEA) data strings to GPS applications.

## About the Integrated GPS on Your Computer

Intermec recommends that you use the GPS Intermediate Driver (GPSID) instead of directly accessing the GPS hardware. The GPSID is a Microsoft software component that interacts between applications and the GPS hardware.

As a Microsoft software component, the GPSID:

- allows multiple applications to simultaneously access the GPS data stream.
- provides access to GPS data without requiring applications to recognize and parse NMEA syntax.

## Use the GPSID Installed on the Computer

To use the GPSID installed on your mobile computer, you need to configure the GPSID settings.

- 1 Tap **Start > Settings > System > External GPS**. The GPS Settings screen appears with **Programs** selected.



- 2 Select the COM port that you want your programs to use to get GPS data from your computer.

- 3 Tap **Access** in the horizontal scroll bar and select the **Manage GPS automatically** check box.



- 4 Tap **OK**.

## About the GPS Module Operating Modes

The integrated GPS module has three operating modes:

- Standalone
- MS Assisted (Mobile Station Assisted)
- gpsOneXTRA™ (UMTS computers only)

In Standalone mode, the GPS module relies solely on GPS satellites to determine position.

In MS Assisted mode, the computer can determine position without receiving GPS signals directly from satellites; instead, the computer receives GPS signals and information provided by the cellular network. Even when the computer can receive a satellite signal, MS Assisted can improve position accuracy and reduce the time to determine initial position (Time-To-First-Fix). Check with your cell phone carrier for availability and pricing for MS Assisted service.

Qualcomm's gpsOneXTRA Assistance technology provides enhanced operation for Standalone GPS. This option enables the UMTS-enabled computer to automatically download a small assistance data file from the XTRA servers through a brief internet access session. To use this option, you must have a valid and activated WAN data connection.



**Note:** Internet connection fees may apply.

Another option you can configure with iGPS is the fix interval. The fix interval defines how often the GPS should provide new information. Larger intervals use less power, but many applications require small intervals to work correctly. The default for fix interval, in seconds, is 4. The Flexible Network Radio has a maximum interval of 4.

## Improve GPS Performance on the Computer

Use the iGPS application to improve the performance of the GPS on your CN70, CN70e, or CK70 computer.



**Note:** Anytime you change the GPS settings, the phone module automatically resets.

- 1** Go to **Start > Settings > System > iGPS**.
- 2** In the **Fix Interval** tab, enter a value for the fix interval. The default setting is 4 and should be optimized for most applications.
- 3** Tap the **Fix Type** tab and select one of these options: Standalone (1), MS assisted (2), or **Enable gpsOneXTRA** (check box).
- 4** Tap **OK**.

# 6

## Configure the Computer

Use this chapter to learn about the available methods for configuring your mobile computer and how to use Intermec Settings. You can also use this chapter to learn how to configure network communications and wireless security.

# How to Configure the Computer

You can configure many parameters on the computer such as the bar code symbologies it decodes or the network settings. The values you set for these parameters determine how the computer operates.

There are several ways to configure the computer:

- Directly on the computer. You can use Intermec Settings directly on the computer to change only the settings on that computer. For more information, see the next section, **“Use Intermec Settings on the Computer.”**
- Remotely using Intermec SmartSystems. When you use SmartSystems, you can remotely configure all of your 70 Series mobile computers as well as other SmartSystems-enabled Intermec computers and peripherals. For more information, see **“Use Intermec Settings Remotely with SmartSystems” on page 82.**
- You can use a third-party device management product that supports the computer and Intermec Settings, such as Soti MobiControl or Wavelink Avalanche. For more information, visit the **Device Management** page on the Intermec website.

You can also configure the computer with configuration bundles that you create using SmartSystems Foundation. For more information, see the SmartSystems Foundation Online Help.

## Use Intermec Settings on the Computer

Use Intermec Settings to configure parameters for Intermec applications on the computer as well as some device-specific parameters like volume. You can configure parameters for important functions like data collection and communications.



## Start Intermec Settings

Intermec Settings is located on the System screen.

- Tap **Start > Settings > System > Intermec Settings**. The Intermec Settings Main Menu appears.



## About the Structure of Intermec Settings

Use the tables below to help find the parameters in Intermec Settings that you want to configure. Each table contains the parameters for one of the Intermec Settings Main Menu options.

If you see > next to a menu option, there are more screens available in the next level. If you see ... next to a menu option, there is only one more screen available.

Most parameters are saved as soon as you tap **OK**. Some settings such as the Serial Port Switch require you to reboot the computer for the changes to take effect.

**Data Collection Menu**

<b>Data Collection Options</b>	<b>Parameters You Can Configure</b>
Internal Scanner	<ul style="list-style-type: none"> <li>• Symbologies</li> <li>• Scanner settings</li> <li>• Imager settings</li> <li>• Decode security</li> </ul>
Bluetooth Scanner	<ul style="list-style-type: none"> <li>• Symbologies</li> <li>• Scanner settings</li> <li>• Imager settings</li> <li>• Decode security</li> </ul>
Dock Tethered Scanner	<ul style="list-style-type: none"> <li>• Symbologies</li> <li>• Scanner settings</li> <li>• Scanner port settings</li> <li>• Imager settings</li> <li>• Decode security</li> </ul>
Camera	<ul style="list-style-type: none"> <li>• Symbologies</li> <li>• Scanner settings</li> <li>• Camera settings</li> <li>• Decode security</li> </ul>
BT-Configure on Connect	Bluetooth-configure on connect
Magstripe Reader	<ul style="list-style-type: none"> <li>• Enable magstripe reader</li> <li>• Reader model (read-only)</li> </ul>

**Communications Menu**

<b>Communications Options</b>	<b>Parameters You Can Configure</b>
Device Name	Device name
802.11 Radio	<ul style="list-style-type: none"> <li>• Security choice (supplicant)</li> <li>• Security settings (includes Wi-Fi settings such as enable/disable radio)</li> <li>• IP settings</li> <li>• Certificates</li> </ul>
Ethernet Adapter	IP settings
Bluetooth	Bluetooth settings (power, discoverable, connectable, and so on)

<b>Communications Options</b>	<b>Parameters You Can Configure</b>
WWAN Radio	<ul style="list-style-type: none"> <li>• Add WWAN connection</li> <li>• Edit WWAN connections</li> <li>• Manage WWAN radio</li> <li>• Carrier Selection</li> <li>• WWAN information</li> </ul>
Serial Port Switch	Serial port switch settings (IrDA, docking connector, and back interface)

**Device Settings Menu**

<b>Device Settings Options</b>	<b>Parameters You Can Configure</b>
Date and Time	Date and time settings
Good Read	<ul style="list-style-type: none"> <li>• Internal scanner</li> <li>• Tethered scanner</li> <li>• Bluetooth scanner</li> </ul>
Sounds	<ul style="list-style-type: none"> <li>• Beeper and voice volume</li> <li>• Headset beeper volume</li> <li>• Vibrate mode intensity</li> <li>• Screen taps</li> <li>• Key clicks</li> </ul>
Backlight	Backlight settings (display backlight, keypad backlight, and light level)
Screen	<ul style="list-style-type: none"> <li>• Screen rotation</li> <li>• Screen rotation sensor</li> </ul>
Keypad	Button Remapping (Flashlight timeout, Left side lower button, Handle trigger, Center scan button, Left side upper button, Right side upper button, Right side lower button)
Power Management	<ul style="list-style-type: none"> <li>• Power button</li> <li>• Battery power</li> <li>• External power</li> <li>• Device off sensor</li> </ul>
USB	USB function driver
System Component Versions	System component versions (read-only)
IDL Runtime Versions	ITC50 (read-only)

Device Settings Options	Parameters You Can Configure
Profile Settings Application	Whether these parameter options appear in Profile Settings: <ul style="list-style-type: none"> <li>• Camera</li> <li>• Power</li> <li>• Scanning</li> </ul>
Features Disabled by Policy	None (read-only)

### Printer Menu

Printer Options	Parameters You Can Configure
Printer (if connected through Bluetooth)	Printer settings (Auto detect printer, memory, display, and so on)



**Note:** The Printer menu displays settings for Bluetooth connected printers. The settings that appear in the menu are dependent on the printer that is paired with the device. The printer needs to be using the Wireless Printing application.

### GPS Menu

GPS Options	Parameters You Can Configure
GPS	Bread crumbing settings

### SmartSystems Information Menu

SmartSystems Information Options	Parameters You Can Configure
Identity	Identity information (hardware version, firmware version, OS version, and so on) (read-only)
Administrator	Administrator settings (name, phone, and email)
Location	Location settings (country, state, city, campus, and detail)
Information	Device Notes (read-only)

**Virtual Wedge Menu**

<b>Virtual Wedge Options</b>	<b>Parameters You Can Configure</b>
Enable Virtual Wedge	Enable virtual wedge
Bar Code Scanner Wedge	Bar code scanner wedge settings (bar code scanner grid and label encoding)
Magstripe Reader Wedge	Magstripe Reader Grid

**Core Messaging Service Menu**

<b>Core Messaging Service Options</b>	<b>Parameters You Can Configure</b>
Server IP	Server IP (read-only)
Associated Server IP	Associated server IP
Broadcast Name	Broadcast name
Port	Port (read-only)
Keep Alive Ping Interval	Keep alive ping interval

**Device Monitor Menu**

<b>Device Monitor Options</b>	<b>Parameters You Can Configure</b>
Device Health Controls	<ul style="list-style-type: none"> <li>• Enable Health Data Collection</li> <li>• Enable Device Health Application</li> <li>• Enable Blue Light (LED)</li> <li>• Set Rule File Location</li> <li>• Collect Abuse History</li> <li>• Set Data Refresh Periods</li> </ul>
Device Health Screen Captures	Device health screen capture settings (directory and screen capture allowed)
Disabled Executables	None (read-only)
Device Wipe	Device wipe settings (enable wipe and interval)

**License Manager Menu**

<b>License Manager Options</b>	<b>Parameters You Can Configure</b>
About	About settings (read-only)
License Vault	None (displays applications that are licensed)

### Location Services Menu

Location Services Options	Parameters You Can Configure
Server	Server settings (port and enable server)
Virtual GPS	Virtual GPS settings

For more information on all parameters in Intermec Settings, see the *Intermec Settings Command Reference Manual*.

## Navigate in Intermec Settings

You can easily navigate through the screens in Intermec Settings to find the parameter you need to configure.

To move down a level in Intermec Settings:

- Tap the menu item in the list.

To move back a level in Intermec Settings:

- Tap **Back** or **Cancel** on the Tile bar.

To save a parameter setting:

- Tap **OK**.

To exit Intermec Settings:

- Tap **Menu** > **Exit** or **OK**.

## Configure Profile Settings with Intermec Settings

A profile is a set of predefined values that you can easily apply to the computer to ensure optimal performance in a specific scenario. The end user does not need to figure out the “right” settings because we have already done that work for you. Profile Settings is available from the Start menu so you can make it available to the end user for easy configuration.

Use Intermec Settings to determine the profiles you want the end user to see in the Profile Settings application.

- 1** Go to **Device Settings** > **Profile Settings Application**.
- 2** Select **Camera**, **Power**, or **Scanning**.

- 3 From the Camera, Power, or Scanning submenu, check or clear the **Display** check box for the settings you want to have available to the end user.
- 4 Click **OK** to save your selection.

## **Restore Default Settings to a Menu**

You can restore the items in a single menu to their default settings.

- 1 Navigate to the menu that you want to restore to defaults.
- 2 Tap **Menu > Restore Menu Defaults**.
- 3 When prompted, tap **Yes** to restore the menu default settings.
- 4 If prompted to refresh the computer, tap **Yes**.

## **Restore Default Settings for All Parameters**

You can restore all Intermec Settings parameters to their default settings.

- 1 Tap **Menu > Restore All Defaults**. The application asks if you are sure you want to restore all defaults.
- 2 Tap **Yes**.  
After several minutes, all of the default settings are restored.

## **Hide Menu Items in Intermec Settings**

You can hide items in the Intermec Settings menus if you do not want to have them available for other users to access. Hidden items are not saved when you back up your settings in the SmartSystems console.

On the mobile computer, you can:

- hide menu items by tapping and holding the item, and then choosing **Hide Menu Item** from the popup list. When asked if you want to hide the menu, tap **Yes**.
- restore all hidden items in all menus, by tapping **Menu > Unhide All Items**.



**Note:** When you restore default settings in Intermec Settings, only the settings for visible items are restored to defaults. The settings for hidden menu items are not affected.

## Use Intermec Settings Remotely with SmartSystems

Your mobile computer is SmartSystems-enabled, which lets you open Intermec Settings from the SmartSystems console to remotely configure all of your mobile computers. For more information about SmartSystems, see “[Manage the Computer Using SmartSystems](#)” on page 106.

- 1 In the SmartSystems console, select a mobile computer and right-click.
- 2 From the menu, select **Intermec Settings**.
- 3 Configure the settings you need to change. As you select parameters from the tree structure, help for each parameter appears in the upper right pane of Intermec Settings.
- 4 When you are done making changes, select **File > Save Settings**.

For help using Intermec Settings, click **Help > Contents**. For information about all of the parameters in Intermec Settings, see the *Intermec Settings Command Reference Manual*.

## About Network Communications

You can easily add the mobile computer to your wireless or wired data collection network. You can connect your computer using:

- 802.11a/b/g/n radio communications.
- Ethernet communications.
- Bluetooth communications.
- USB and serial communications.



## Configure 802.11a/b/g/n (Wi-Fi) Radio Communications



Make sure all components with antennas are at least 30 cm (1 ft) apart when power is applied. Failure to comply could result in equipment damage.

The mobile computer contains an 802.11 radio to transfer data using wireless communications and to support the TCP/IP network protocols. This section of the manual assumes that your wireless network is set up, including your access points.

By default, the 802.11 radio is disabled. Use the following procedure to enable the Wi-Fi radio using Intermec Settings. If you would like to use ScanNGo bar codes to easily enable the radio and set the default security settings, see Appendix C “[ScanNGo Wi-Fi Configuration Bar Codes](#)” on page 177.

- 1 Tap **Start** > **Settings** > **System** > **Intermec Settings**.
- 2 From the Intermec Settings main menu, tap **Communications** > **802.11 Radio** > **Radio Enabled**.
- 3 Select the **Radio Enabled** check box and tap **OK**. By default, the computer uses Funk security and enables DHCP.
- 4 Use Intermec Settings to configure any other parameters you need to use for communication with your network.
- 5 Configure 802.11 security. For help, see “[About Wireless Security](#)” on page 92.

## Configure Ethernet Communications

To configure Ethernet communications, connect your mobile computer to your Ethernet network using the Ethernet Snap-On Adapter (Model 1000AA01) or an Ethernet dock.

- 1 Connect the Ethernet snap-on adapter to your mobile computer.

- 2 Connect the Ethernet cable from your network to the snap-on adapter or dock.

Ethernet communications are automatically enabled on your mobile computer.

- 3 Make sure that your computer is communicating with the network. The network connection icon (📶) should appear on the title bar.

## Configure Bluetooth Communications

Your mobile computer is Bluetooth™-enabled, which lets you connect to other Bluetooth devices, such as scanners, printers, or audio devices.

You need to turn on the Bluetooth radio before you can discover and connect to other Bluetooth devices. By default, the radio is turned off. You can configure Bluetooth communications using Intermec Settings or from the Start menu.

- 1 Tap **Start > Settings > Bluetooth > Mode**.
- 2 Select the **Turn on Bluetooth** check box.

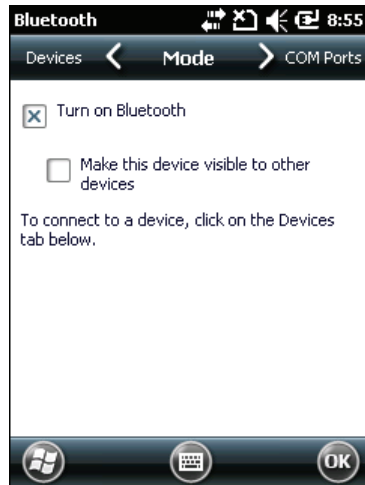

- 3 (Optional) If you want your computer to be visible to other Bluetooth devices, select **Make this device visible to other devices**.

**4 Tap OK.**

The Bluetooth radio maintains its state through a reboot or cold boot and maintains virtual COM ports. But, if you clean boot your computer you need to recreate pairings to devices.

**Connect to a Bluetooth Scanner**

You can connect the computer to an Intermec Bluetooth scanner, such as the SF51 or SR61.

**1 Tap Start > Settings > System > Wireless Scanning.**



**2 Tap Add Device.**



**3 Select Quick Connect, Search, or Manual.** Follow the onscreen instruction to add a wireless scanner.

## Connect to a Bluetooth Printer

To configure your computer for Bluetooth wireless printing, you need to:

- create an application that opens the wireless printing COM port on your computer. For help, see the Bluetooth Resource Kit, which is part of the Intermec Developer Library (IDL), available from the Intermec website at [www.intermec.com/idl](http://www.intermec.com/idl).
- select the current wireless printer on your computer. For help, see the next procedure.



**Note:** You can also print wirelessly using Microsoft APIs with Bluetooth extensions for Winsock and Bluetooth virtual COM ports. For help, see the Bluetooth Resource Kit documentation.

### 1 Tap **Start** > **Settings** > **System** > **Wireless Printing**.

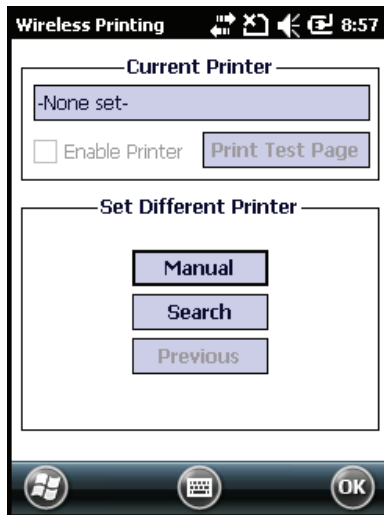

- 2 Tap **Search** to find a printer, or tap **Manual** to enter a device address. Follow the onscreen instructions to select the current wireless printer.
- 3 (Optional) Tap **Print Test Page**. The printer prints out a test page.

## Connect to a Bluetooth Audio Device

Use the Bluetooth Audio enabler to discover, activate, and connect to Bluetooth audio devices such as a headset. This enables system sounds to be monitored through the headset.

- 1 Tap **Start > Settings > System > Bluetooth Audio**.



- 2 Tap **Search** to find your Bluetooth headset or hands-free device.
- 3 Select your device from the list and configure any settings.
- 4 Click **OK** when you are done.

## About Serial and USB Communications

You can use these 70 Series accessories to transmit data to and receive data from another device through serial or USB communications:

- RS-232 Snap-On Adapter (Model 1000AA03)
- USB Snap-On Adapter (Model 1000AA07)

For more information about these accessories and how to order them, see **“70 Series Accessories” on page 8**.

## Connect to a Tethered Scanner

Use this procedure to connect your mobile computer to an SR30, SR61T, or ASCII tethered scanner and enable RS-232 communications.

- 1 Tap **Start > Settings > System > Intermec Settings > Communications > Serial Port Switch**.
- 2 Select **Standard docking and IrDA** and tap **OK**.  
If the serial port switch is set to one of the other options, you need to select **Standard docking and IrDA** and then save and reboot the computer before you proceed.
- 3 Tap **Back** to return to the Main Menu.
- 4 Tap **Data Collection > Dock Tethered Scanner > Enable scanner auto-detect**.
- 5 Select the **Enable scanner auto-detect** check box and tap **OK**.
- 6 Perform one of these items based on the type of scanner you are connecting:
  - For an SR30 or SR61T scanner, tap **Scanner Settings**, select **SR Intermec Scanner**, and then tap **OK**.
  - For an ASCII scanner, tap **Scanner Settings**, select **ASCII**, and then tap **OK**. Set up the appropriate COM port settings by selecting **Scanner Port Settings**.
- 7 Connect the RS-232 snap-on adapter with the attached scanner to the bottom of the mobile computer.

## Create an ISP Connection

You can create an Internet Service Provider (ISP) connection to send and receive email messages using Messaging (Outlook Email) and view web pages using Internet Explorer Mobile. You need to get your ISP dial-up access telephone number, a user name, and a password from your ISP.

- 1 Tap **Start > Settings > Connections > Connections**.
- 2 Under **My ISP**, tap **Add a new modem connection**.

- 3** Enter a name for the connection, such as “ISP Connection.”
- 4** If you are using an external modem connected to your mobile computer with a cable, select **Hayes Compatible on COM1** from the **Select a modem** list.
- 5** Tap **Next**.
- 6** Enter the access phone number and then tap **Next**.
- 7** Enter the **User name**, **Password**, and **Domain** (if provided by an ISP or your network administrator).
- 8** Tap **Finish**.
- 9** On the Connections screen, tap **Advanced** on the horizontal scroll.



- 10** Tap **Dialing Rules**.
- 11** When the Enable Dialing Rules box appears, tap **OK**.
- 12** Tap **Edit**.
- 13** In the **Name** field, enter your phone type (**Home**, **Mobile**, or **Work**).
- 14** Tap **OK** until you exit the Connections screen.



## Create a VPN Server Connection

You can create a Virtual Private Network (VPN) connection to securely connect to servers, such as a corporate network, through the Internet. Before you can create a VPN connection, you need this information from your network administrator:

- User name
- Password
- Domain name
- TCP/IP settings
- Host name or IP address of the VPN server

After you have located this information, you can create a VPN server connection.

- 1** Tap **Start > Settings > Connections > Connections**.
- 2** Under **My Work Network**, tap **Add a new VPN server connection**.
- 3** Step through the screens to set up your VPN connection.



## About Wireless Security

The computer provides five types of security for your wireless network:

- Wi-Fi Protected Access 2 (WPA2™)
- Wi-Fi Protected Access (WPA)
- 802.1x
- LEAP
- WEP

This section explains how to configure wireless security on your mobile computer. Intermec recommends that you implement WPA2 security using PSK (Personal) or 802.1X (Enterprise) key management as appropriate.

You must use either Funk or Microsoft security to implement your security solution. For details, see the next section, **“Choose Between Microsoft and Funk Security.”** Intermec recommends that you always implement WPA2 security using PSK (Personal) or 802.1X (Enterprise) key management.

If you are using WPA-802.1x, WPA2-802.1x, or 802.1x security, this section also assumes that your authentication server and authenticators are properly configured.



**Note:** Your security choice does not depend on your authentication server. For example, you can choose Funk security if you use Microsoft Active Directory® to issue certificates.

## Choose Between Microsoft and Funk Security

The computer supports both Funk and Microsoft security, which dynamically select wireless networks based on your preferences. The option you choose depends on your network security needs.

- If you are using the computer in a static environment that requires a high level of security, you should use Funk security, which offers CCX v4.0 compliance, support for LEAP and TTLS, and configuration for up to four profiles.

To use Funk security, you need to select a profile. For help, see the next section, **“Select a Funk Security Profile.”**

- If you are primarily using the computer to connect to Wi-Fi hotspots, you may want to use Microsoft security.  
To use Microsoft security, you need to select it as your security choice. For help, see “[Select Microsoft as Your Security Choice](#)” on page 97.

## **Select a Funk Security Profile**

You can define up to four profiles for Funk security. Different profiles let your computer communicate in different networks without having to change all of your security settings. For example, you may want to set up one profile for the manufacturing floor and one for the warehouse. By default, the active profile is Profile 1.

### **Select a Funk Security Profile**

Use the following procedure to select a Funk security profile.

- 1 Start Intermec Settings.
- 2 Select **Communications > 802.11 Radio > Funk Security**.
- 3 Select a profile. A list of configurable settings appears.
- 4 (Optional) In the **Profile Label** text box, enter a meaningful name for your profile.
- 5 Configure your security settings. For help, see the next sections.
- 6 Repeat Steps 3 through 5 for each profile you want to define.
- 7 Set an active profile by choosing it in the **Active Profile** list.
- 8 Save your settings.

### **Configure WPA or WPA2 Enterprise (802.1x) Security with Funk**

Use these procedures to set WPA-802.1x or WPA2-802.1x security on your computer with Funk security.

- 1 Make sure the communications and radio parameters on your 70 Series are configured.
- 2 Make sure Funk is selected as your security choice.
- 3 Start Intermec Settings.
- 4 Select **Communications > 802.11 Radio > Funk Security**.

- 5 Select the profile you want to configure.
- 6 For **Association**, select **WPA** or **WPA2**. Encryption automatically defaults to **TKIP** or **AES**, respectively.
- 7 For **8021x**, select **TTLS**, **PEAP**, **EAP-FAST**, or **TLS**.
- 8 If you selected **TTLS**, **EAP-FAST**, or **PEAP**:
  - a For **Prompt for Credentials**, select **Enter credentials now**.
  - b Enter a **User Name** and **User Password**.
  - c For **Validate Server Certificate**, select **Yes**.



**Note:** The correct date must be set on your computer when you enable **Validate Server Certificate**.

- 9 If you selected **TLS**:
  - a Load a user and root certificate on your computer. For help, see [“Load a Certificate” on page 102](#).
  - b Enter a **User Name** and **Subject Name**.
  - c For **Validate Server Certificate**, select **Yes**.

### **Configure WPA or WPA2 Personal (PSK) Security with Funk**

Use the following procedure to configure WPA-PSK or WPA2-PSK with Funk security.

- 1 Make sure the communications and radio parameters on your computer are configured.
- 2 Make sure Funk is selected as your security choice.
- 3 Start Intermec Settings.
- 4 Select **Communications > 802.11 Radio > Funk Security**.
- 5 Select the profile you want to configure.
- 6 For **Association**, select **WPA** or **WPA2**.
- 7 For **8021x**, select **None**.

- 8** For **Pre-Shared Key**, enter the pre-shared key or passphrase.

The pre-shared key must be a value of 32 hex pairs preceded by 0x for a total of 66 characters. The value must match the key value on the access point. The passphrase must be from 8 to 63 characters. After you enter a passphrase, the 70 Series internally converts it to a pre-shared key. This value must match the passphrase on the authenticator.

- 9** Save your settings.

### **Configure 802.1x Security with Funk Security**

Use the following procedure to configure 802.1x-WEP security with Funk security. Intermec recommends that you use WPA2-802.1x instead of 802.1x-WEP if possible.

- 1** Make sure the communications and radio parameters on your computer are configured.
- 2** Make sure Funk is selected as your security choice.
- 3** Start Intermec Settings.
- 4** Select **Communications > 802.11 Radio > Funk Security**.
- 5** Select the profile you want to configure.
- 6** For **Association**, select **Open**.
- 7** For Encryption, select **WEP**.
- 8** For **8021x**, select **TTLS**, **PEAP**, or **TLS**.
- 9** If you selected **TTLS** or **PEAP**:
  - a** Enter a **User Name**.
  - b** For **Prompt for Credentials**, select **Enter credentials now**.
  - c** Enter a **User Password**.
  - d** For **Validate Server Certificate**, select **Yes**.

- 10** If you select **TLS**:
  - a** Load a user and root certificate on your computer. For help, see **“Load a Certificate” on page 102**.
  - b** For **Validate Server Certificate**, select **Yes**.
  - c** Enter a **User Name** and **Subject Name**.
- 11** Save your settings.

### **Configure LEAP Security with Funk**

After you configure the communications and radio parameters on your mobile computer and select Funk as your security choice, you can configure LEAP.

- 1** Start Intermec Settings.
- 2** Select **Communications > 802.11 Radio > Funk**.
- 3** Select the profile you want to configure.
- 4** For **8021x**, select **LEAP**.
- 5** For **Association**, select **Open**, **WPA**, **WPA2**, or **Network EAP**. Encryption automatically defaults to **TKIP** if you selected **WPA**, **AES** if you selected **WPA2**, and **WEP** if you selected **Open** or **Network EAP**.
- 6** For **Prompt for Credentials**, select **Enter credentials now**.
- 7** Enter a **User Name** and **User Password**.
- 8** Save your settings.

### **Configure Static WEP Security with Funk Security**

Use the following procedure to configure static WEP security with Funk. Intermec recommends that you use WPA2-PSK instead of WEP if possible.

- 1** Make sure the communications and radio parameters on your computer are configured.
- 2** Make sure Funk is selected as your security choice.
- 3** Start Intermec Settings.
- 4** Select **Communications > 802.11 Radio > Funk Security**.

- 5** Select the profile you want to configure.
- 6** For **Association**, select **Open**.
- 7** For **Encryption**, select **WEP**.
- 8** For **8021x** select **None**.
- 9** Define a value for the keys you want to use. You can define up to four keys (**Key 1** through **Key 4**).  
  
Enter an ASCII key or a hex key that is either 5 bytes or 13 bytes long depending on the capability of the radio. Set a 5- byte value for 64-bit WEP or a 13-byte value for 128-bit WEP. Hex keys must be preceded by 0x and contain 5 or 13 hex pairs.
- 10** For **Transmit key**, select the key you want to use for transmitting data.
- 11** Save your settings.

### **Use Open (No Security) Associations with Funk**

Use the following procedure to configure your mobile computer for open security using Funk.

- 1** Start Intermec Settings.
- 2** Select **Communications > 802.11 Radio > Funk Security**.
- 3** Select the active profile you are using.
- 4** For **Association**, select **Open**.
- 5** For **Encryption**, select **None**.
- 6** Tap **OK**. Your settings are saved.

### **Select Microsoft as Your Security Choice**

The default security setting is Funk. If you want to use Microsoft Wireless Zero Configuration (WZC) security, you need to select it as your security choice. After you select Microsoft as your security choice, you will be prompted to save your settings and reset the computer for your change to take effect.

With Microsoft as your security choice, you can configure:

- WPA or WPA2
- 802.1x
- Static WEP

### Select Microsoft Security

Use the following procedure to select Microsoft security.

- 1** Start Intermec Settings. For help, see [“Configure the Computer” on page 73](#).
- 2** Select **Communications > 802.11 Radio > Security Choice**.
- 3** From the **Security Choice list**, select **Microsoft Security**. An alert box appears telling you that you must save your settings and reboot the computer for the new security choice to take effect.
- 4** Select **Yes**. The computer resets and starts with Microsoft Security as the Security Choice.

### Configure WPA or WPA2 Enterprise (802.1x) Security with Microsoft

Use these procedures to set WPA-802.1x security on your computer with Microsoft security.

- 1** Make sure the communications and radio parameters on your computer are configured.
- 2** Start Intermec Settings.
- 3** Select **Communications > 802.11 Radio > Microsoft Security**.
- 4** For **Infrastructure Mode**, select **Infrastructure**.
- 5** For **Network Authentication**, select **WPA** or **WPA2**. Data Encryption automatically defaults to **TKIP** for WPA and **AES** for WPA2.
- 6** For **802.1x Authentication**, select either **TLS**, or **PEAP**.



**7** If you selected **TLS**:

- a** Load a user and root certificate on your computer. For help, see **“Load a Certificate” on page 102**.
- b** Select **Properties**. The Certificates dialog box appears.
- c** Select the certificate you want to use from the list. The User Logon dialog box appears.
- d** Enter a **User Name** and **Domain** and tap **OK**.
- e** Tap **OK** to exit the Certificates dialog box.
- f** Press **OK** to save the Microsoft Security settings.

**8** If you selected **PEAP**:

- a** Load a root certificate of the authentication server on your computer. For help, see **“Load a Certificate” on page 102**.
- b** Press **OK** to save the security settings and the User Logon dialog box appears.
- c** Enter a **User Name**, **Password**, and **Domain**. Select **Save Password** if you want to save the password for future authentication sessions.
- d** Press **OK** to save the Microsoft Security settings.

**Enable WPA or WPA2 Personal (PSK) Security with Microsoft**

Use the following procedure to enable WPA-PSK with Microsoft Security.

- 1** Make sure the communications and radio parameters on your computer are configured.
- 2** Start Intermec Settings.
- 3** Select **Communications > 802.11 Radio > Microsoft Security**.
- 4** For **Infrastructure Mode**, select **Infrastructure**.
- 5** For **Network Authentication**, select **WPA-PSK**. Data Encryption automatically defaults to **TKIP** for WPA and **AES** for WPA2.

- 6 For **Pre-Shared Key**, enter the pre-shared key or the passphrase.

The pre-shared key must be a value of 32 hex pairs preceded by 0x for a total of 66 characters. The value must match the key value on the authenticator. The passphrase must be from 8 to 63 characters. After you enter a passphrase, the computer internally converts it to a pre-shared key.

- 7 Save your settings.

### Configure 802.1x Security with Microsoft

Use the following procedure to configure 802.1x security with Microsoft security. Intermec recommends that you use WPA2-802.1x instead of 802.1x-WEP if possible.

- 1 Make sure the communications and radio parameters on your computer are configured.
- 2 Start Intermec Settings.
- 3 Select **Communications > 802.11 Radio > Microsoft Security**.
- 4 For **Infrastructure Mode**, select **Infrastructure**.
- 5 For **Network Authentication**, select **Open**.
- 6 For **Data Encryption**, select **WEP**.
- 7 For **802.1X Authentication**, select **TLS** or **PEAP**.
- 8 If you selected **TLS**:
  - a Load a user and root certificate on your computer. For help, see **“Load a Certificate” on page 102**.
  - b Select **Properties**. The Certificates dialog box appears.
  - c Select the certificate you want to use from the list. The User Logon dialog box appears.
  - d Enter a **User Name** and **Domain** and tap **OK**.
  - e Tap **OK** to exit the Certificates dialog box.
  - f Press **OK** to save the Microsoft Security settings.

- 9** If you selected PEAP:
  - a** Load a root certificate of the authentication server on your computer. For help, see **“Load a Certificate” on page 102**.
  - b** Press **OK** to save the security settings and the User Logon dialog box appears.
  - c** Enter a **User Name**, **Password**, and **Domain**. Select **Save Password** if you want to save the password for future authentication sessions.
  - d** Press **OK** to save the Microsoft Security settings.
- 10** For **Network Key Setting**, select **Automatic**.
- 11** Save your settings.

### **Configure Static WEP Security with Microsoft**

Use the following procedure to configure static WEP security with Microsoft security. Intermec recommends that you use WPA2-PSK instead of WEP if possible.

- 1** Make sure the communications and radio parameters on your computer are configured.
- 2** Start Intermec Settings.
- 3** Select **Communications > 802.11 Radio > Microsoft Security**.
- 4** For **Network Authentication**, select **Open**.
- 5** For **Data Encryption**, select **WEP**.
- 6** For **Network Key Setting**, select **Enter Key and Index**.
- 7** For **Network Key Value**, enter an ASCII key or a hex key that is either 5 bytes or 13 bytes long depending on the capability of the radio.  
  
Set a 5-byte value for 64-bit WEP or a 13-byte value for 128-bit WEP. Hex keys must be preceded by 0x and contain 5 or 13 hex pairs.
- 8** For **Network Key Index**, select the key you want to use for data transmission.
- 9** Save your settings.

### **Use Open (No Security) Associations with Microsoft**

Use the following procedure to configure your mobile computer for open security using Microsoft WZC.

- 1** Start Intermec Settings.
- 2** Select **Communications > 802.11 Radio > Microsoft Security**.
- 3** For **Network Authentication**, select **Open**.
- 4** For **Data Encryption**, select **Disabled**.
- 5** Tap **OK**. Your settings are saved.

### **Load a Certificate**

To use transport layer security (TLS) with WPA or 802.1x security, you need a unique client certificate on the computer and a trusted root certificate authority (CA) certificate. Certificates are pieces of cryptographic data that guarantee a public key is associated with a private key. They contain a public key and the entity name that owns the key. Each certificate is issued by a certificate authority.

- 1** Start Intermec Settings.
- 2** Go to **Start > Settings > System > Intermec Settings**.

- 3 Tap **Communications** > **802.11 Radio** > **Certificates**. The Certificates screen appears.



- 4 To import a certificate chain:
- a Tap **Import Certificates** to install the selected certificate.
  - b In the CertImportUI screen, tap the <<< button next to the Select pfx to import text field.
  - c Select the root certificate from the list.
  - d Tap **Import Certificate**.
- 5 To import user and root certificates from a Microsoft IAS server:
- a Tap **Import Certificates**.
  - b Tap **Web Enrollment**.
  - c Enter the **User**, **Password**, and **Server** (IP address) to log into the server.
  - d Tap **OK**. A dialog box appears asking if you want to load the root certificate.
  - e Tap **OK**. The Enrollment Tool message box appears telling you that the certificate has been added.
  - f Tap **OK** to close the message box.



# 7

## Manage the Computer

Use this chapter to learn how to remotely update, configure, and monitor your Intermec mobile computers. You will also find information on installing and developing software applications as well as how to upgrade the system software.

## **Manage the Computer in Your Network**

When you have multiple mobile computers and peripherals in your network, it is essential to have an easy way to manage updates, configure all of the devices, and remotely troubleshoot problems. Intermec provides a free device management software platform called SmartSystems™ Foundation to help you manage your devices. You can also purchase third-party device management software through a vendor.

### **Manage the Computer Using CloneNGo**

Intermec CloneNGo is a software application that allows you to copy the settings and parameters from a master computer onto one or more client computers. Cloning reduces redundancy and error by providing an efficient and accurate way to copy and transmit settings from a master computer to one or more client computers through an adhoc wireless network. For more information on using CloneNGo, see the *CloneNGo User Guide*.

### **Manage the Computer Using SmartSystems**

Intermec SmartSystems is a software platform that lets you manage all of your SmartSystems-enabled devices simultaneously from a central server. The SmartSystems console displays all SmartSystems-enabled computers and peripherals in your network.



**Intermec SmartSystems Console**

Through the console, you can:

- drag-and-drop configuration bundles, operating system updates, and firmware upgrades to multiple computers.
- save configuration settings from a single device and deploy those settings to many devices simultaneously.
- remotely change settings on SmartSystems-enabled computers and peripherals.

The SmartSystems console can report on asset locations and battery status, making it easier to manage your mobile devices.

With a Provisioning license, SmartSystems can automatically push software, configuration settings, and other files to connected mobile computers. The license also enables ScanNGo, which makes connecting additional mobile computers to your wireless network as easy as reading bar codes. You can download SmartSystems from the Intermec website at no charge. For more information, visit [www.intermec.com/SmartSystems](http://www.intermec.com/SmartSystems). To purchase a Provisioning license, contact your local Intermec sales representative.

## Manage the Computer Using Third-Party Software

You can use third-party software such as Wavelink Avalanche to centrally manage your Intermec devices. Device management software enables you to update software, increase security, track your assets, and troubleshoot devices remotely. You can download the Wavelink Enabler for the mobile computer from the Wavelink website. For more information, visit the Intermec website and search for Wavelink Avalanche or visit [www.wavelink.com](http://www.wavelink.com) to download the enabler.

## Develop and Install Applications

Use the Intermec Resource Kits to develop applications to run on the mobile computer. The Resource Kits are a library of C++, .NET, Java, and web components grouped by functionality that you can use to create applications for the computer. The Resource Kits are part of the Intermec Developer Library (IDL), and can be downloaded from the Intermec website at [www.intermec.com/idl](http://www.intermec.com/idl).

For more information, see the *Intermec Developer Library Resource Kit Developer Guide*.

## Package Your Application

For very simple applications, the executable file may be the only file you need to deploy. More typically, you will have a set of files to install.

Intermec recommends using .cab files to install your applications. The computer uses standard Windows Mobile .cab files and will install third-party .cab files.

## Choose a Target Location

You can have your .cab file place your application in any of these memory locations on the mobile computer:

- The ObjectStore.
- The optional microSD card. Depending on available disk space, you may want to consider installing your application files on the microSD card. Using a card creates the Storage Card folder on the computer.

- The non-volatile Flash File Store. Applications and data in the Flash File Store will persist through a clean boot.



**Note:** The Flash File Store is erased if you reflash the operating system image.

Files copied to any of these locations are safe when you cold boot the computer as long as the AutoRun system is installed in the appropriate location. When AutoRun is installed on the computer, all .cab files in the CabFiles folder are automatically extracted after a cold boot. For more information about AutoRun, see the *Intermec Developer Library Resource Kit Developer Guide*.

## Install Applications Using SmartSystems Foundation Console

You can use the SmartSystems console to drag-and-drop Intermec applications onto your mobile computer. The console is part of SmartSystems Foundation.

- 1 Download your application file from the Intermec website and unzip it on your desktop PC.
- 2 Double-click the application file to install it. The application file should appear in the Software Vault.
- 3 From the SmartSystems console in the Software Vault, drag-and-drop the application onto each mobile computer in your network, or drop the application on a group of computers contained in a folder.

## Install Applications Using Microsoft ActiveSync

When you only have a few computers to update with applications, you can copy files using Microsoft ActiveSync. This procedure assumes that Microsoft ActiveSync is installed on your PC and is up and running.

- 1 Connect to the mobile computer via ActiveSync.
- 2 Copy the .cab files from your development PC to the computer.

- 3 Reboot or cold boot the computer.
- 4 After the boot process is finished, browse to the .cab files and tap the files to install them.

## **Install Applications Using a Storage Card**

Use a storage card to install applications on one computer at a time or if you have no network connection.

- 1 Copy your application file to the storage card.
- 2 Install the storage card in the mobile computer.
- 3 On the mobile computer, browse to the Storage Card folder and run your application.

## **Launch Applications Automatically**

There are two ways to launch an application automatically on a cold boot:

- Set up your .cab file to place a shortcut to the application in the \Windows\StartUp directory at install time.
- Use AutoRun.exe to start your application at boot time. AutoRun ships on the computer and automates other operations.

At boot time, AutoRun executes any commands found in its data file, Autouser.dat. For more information on how to use the AutoRun.exe feature, view the Readme.txt file located in the My Device\Flash File Store\2577 directory on your computer.

## **Update the System Software**

The mobile computer uses SmartSystems bundles to update the operating system (OS) and the system software.

You can use these methods to update your mobile computer:

- You can update individual computers, or multiple computers at the same time using the SmartSystems console. For help, see the next section, **“Update Individual or Multiple Computers Using the SmartSystems Console”**.
- You can update individual computers using a microSD card.

## Update Individual or Multiple Computers Using the SmartSystems Console

You can use the SmartSystems console to update the operating system or system software on your mobile computer. The console is part of SmartSystems Foundation and is available from the Intermec website. Before you can update your mobile computer, you need:

- SmartSystems Foundation. To download SmartSystems Foundation, go to [www.intermec.com/SmartSystems](http://www.intermec.com/SmartSystems) and click the Downloads tab.
- the SmartSystems bundles you want to install. These SmartSystems bundles are available from the Intermec website at [www.intermec.com](http://www.intermec.com). Go to **Support > Downloads > OS/Firmware/Drivers** list.

After you have located these items, you can update your mobile computer using SmartSystems Foundation.

- 1 Open the SmartSystems console.
- 2 Make sure the mobile computer is discovered.
- 3 Make sure the mobile computer is in a powered dock or that power management is disabled.
- 4 Download the SmartSystems bundle to your PC.
- 5 Double-click the SmartSystems bundle on your PC to extract the update files to the software vault.
- 6 From the SmartSystems console, locate the bundle to install and drag them to each mobile computer (or group in a folder) you want to update. The SmartSystems console installs the update on your mobile computers.

After the download is complete, your mobile computer begins the update process and automatically performs a cold boot. The computer then boots into a special Update Loader mode where the computer has no network connections and is completely unusable. This process can take anywhere from 30 seconds to 15 minutes depending on the update.

After the update is complete, the computer boots again.



**Note:** The SmartSystems console indicates that your mobile computer is offline, by displaying a red stop symbol, until the computer reboots and reconnects to the system.

## Update Individual Mobile Computers Using a microSD Card

You can transfer upgrade bundles from your desktop PC to your mobile computer using a storage card. Before you can update your mobile computer, you need:

- the SmartSystems bundles you want to install. These SmartSystems bundles are available from the Intermec website at [www.intermec.com](http://www.intermec.com). Go to **Support > Downloads > OS/Firmware/Drivers** list.
- a microSD card formatted to FAT or FAT32.

After you have located these items, you can update your mobile computer using a storage card.

- 1 Download the SmartSystems bundle to your PC and note the download location.
- 2 On your desktop PC, navigate to the download location and select the folder with the correct firmware version. For example, umts\_wwe or umts\_tp.
- 3 Transfer the autoflash.img file into the root directory of the microSD card.
- 4 Turn off your mobile computer and install the microSD card in your mobile computer. For help, see **“Insert a MicroSD Card” on page 30**.
- 5 Turn on your mobile computer.

The update process begins. Your mobile computer may restart several times during this process. When the update is complete, the Autoflash Complete message appears.

- 6 Remove the microSD card.



**Note:** If you do not remove the storage card, the update process repeats each time the computer reboots.

- 7 Reboot your mobile computer and follow the setup process.

# 8

## Troubleshoot and Maintain the Computer

If you encounter any problems while using the 70 Series computer, look in this chapter to find a possible solution. You will also find information on routine maintenance.

## About the Intermec Dashboard

The Intermec Dashboard is designed to provide proactive monitoring of your mobile computers to prevent downtime. You can easily see the health of the device and can help pinpoint the source of a problem to determine if it is hardware or software related.

Intermec Dashboard displays information such as the status of network connections, battery usage, storage space, and internal devices. It also provides system information such as the operating system, firmware, and hardware configuration.

- Press the Intermec Dashboard button (Ⓜ) on the computer keypad.

### Intermec Dashboard Main Screen



Intermec Dashboard is highly integrated with SmartSystems Foundation. You can use SmartSystems Foundation to remotely monitor the health of your computers. For more information, refer to the SmartSystems online help.



# Troubleshoot Your Mobile Computer

Use the troubleshooting tables in this section to fix problems with the Wi-Fi connection, 802.1x security, the imager, or general problems with operating the mobile computer.

If you send the computer in for service, it is your responsibility to save the computer data and configuration. Intermec is responsible only for ensuring that the hardware matches the original configuration when repairing or replacing the computer.

## Troubleshoot the Wi-Fi Connection

Use this troubleshooting table to help solve problems with your 802.11 radio connection.

### ***Problems With the Wi-Fi Connection***

<b>Problem</b>	<b>Solution</b>
When you turn on the computer after it was suspended for a while (10 to 15 minutes or longer), it can no longer send or receive messages over the network.	Host may have deactivated or lost current terminal emulation session. In a TCP/IP direct connect network, turn off the “Keep Alive” message from host to maintain the TCP session while the computer is suspended.
The computer is connected to the network and you move to a new site to collect data. Your computer now shows you are not connected to the network.	Move closer to an access point or to a different location to reestablish communications until you reconnect with the network.
The computer appears to be connected to the network, but you cannot establish a terminal emulation session with the host computer.	There may be a problem with the host computer, or with the connection between the access point and the host computer. Check with the network administrator to make sure the host is running and allowing users to log in to the system.
The computer appears to be connected to the network, but the host computer is not receiving any information from the 70 Series computer.	There may be a problem with the connection between the access point and the host computer. Check with the network administrator or use your access point user’s manual.

Problem	Solution
A network connection icon appears in the toolbar, but then disappears.	<p>The computer may not be communicating with the intended access point. Make sure the network name matches the access point network name. Default network name is “INTERMEC.”</p> <p>The access point may not be communicating with the server. Ensure the access point is turned on, properly configured, and has 802.1x security enabled.</p>

## Troubleshoot 802.1x Security

Use the following table to troubleshoot problems with your 802.1x security that will prevent you from connecting to your network, such as an incorrect password.

### Problems With 802.1x Security

Problem	Solution
The computer indicates it is not authenticated.	<p>Make sure that:</p> <ul style="list-style-type: none"><li>• the User Name and Password parameters on the computer must match the user name and password on authentication server. You may need to reenter the password on both the computer and authentication server.</li><li>• on your authentication server, the user and group are allowed and the group policy is allowed to log into the server. For help, see the documentation that shipped with your authentication server software.</li><li>• the IP address and secret key for access point must match the IP address and secret key on the authentication server. You may need to reenter the IP address and secret key on both your access point and authentication server.</li><li>• the authentication server software is running on the server PC.</li></ul>
You receive a message saying “The server certificate has expired or your system date is incorrect” after you perform a clean boot on the computer.	<p>Date and time are not saved when you perform a clean boot. Reenter the date and time, and then save your changes.</p>

## Check 802.11 Network Status

If you have trouble connecting to your 802.11 wireless network:

- Make sure you have correctly set network parameters on the computer.
- Check your wireless security settings.

Follow the next procedure to verify available access points and networks, check signal strength, and view other diagnostics. If you need to contact Intermec Product Support, this information can be helpful in troubleshooting wireless network connection issues.

**1** Tap **Start** > **iSpyWiFi**. The ISpyWiFi application launches.

The ISpyWiFi tab shows:

- MAC address and IP address of the 802.11 radio.
  - network association status, including the SSID and MAC address of the access point.
  - security configuration.
  - radio transmit power and signal strength information.
- 2** Tap the **Scan** tab to view a list of available 802.11 networks. The list includes the signal strength, channel, and MAC address for each network.
- Tap **Scan** to refresh the screen.
- 3** Tap the **Supp** tab to view radio supplicant information, including a list of supplicant events and authentication status.
- To verify the settings for the currently active security profile, tap **Configure Profile**. Intermec Settings launches for you to configure 802.11 Radio settings.
  - To try reconnecting to the network, tap **Reconnect**.
  - To delete the events in the list, tap **Clear Events**.
- 4** Tap the **Ping** tab to run a ping test to the host.
- a** In the **Host** field, enter the IP address of the host.
  - b** From the **Repetitions** list, choose the number of times the computer will ping the host.

- c** Tap **Ping**. The graph shows the amount of time it takes for the host to return the ping. Tap **List** to see this information in a list format.
- 5** Tap the **RSSI** tab to view the received signal strength of the host signal.

The information box includes the current signal strength, host SSID name, MAC address, data rate, and transmit power.

  - Tap **Mark** to place an arrow marker above the graph.
- 6** Tap the **Conf** tab to set up a log file that lists RSSI history.

This screen includes the 802.11 radio driver version and available radio modes.

  - a** Check the **Log to File** check box.
  - b** (Optional) Change the sample period and number of samples displayed.
  - c** Tap **Log File**. The Save As screen appears.
  - d** (Optional) Change the name of the saved log file, the folder to which the file will be saved, the content type (log or text), and the location.
  - e** Tap **OK**.

## **Troubleshoot Reading Bar Codes**

Use this section to troubleshoot problems that may prevent you from being able to read a bar code, such as the symbology not being enabled.

### **Problems Reading Bar Codes**

<b>Problem</b>	<b>Solution</b>
You cannot see the illumination beam or frame from the imager when you press the Scan button and aim the imager at a bar code label.	<ul style="list-style-type: none"><li>• You may be too far away from the bar code label. Try moving closer to the bar code label and scan it again.</li><li>• You may be reading the bar code label “straight on.” Change the reading angle and try again.</li><li>• The imager hardware trigger might be disabled in Intermecc Settings. To check the setting go to <b>Start &gt; Settings &gt; Systems &gt; Data Collection &gt; Scanner Settings</b>. Hardware trigger should be checked.</li></ul>

Problem	Solution
When you release a <b>Scan</b> button or handle trigger, the <b>Good Read</b> light does not turn off.	The <b>Good Read</b> light will remain on if you configure the computer to use continuous/edge triggering. If you configure the computer for level triggering and the <b>Good Read</b> light remains on, there may be a problem. Press one of the <b>Scan</b> buttons or pull the trigger again without scanning a bar code label. If the light is still on, contact your local Intermec representative.
The scanner will not read the bar code label.	<ul style="list-style-type: none"> <li>• Aim the scanner beam to cross the entire bar code label in one pass. Vary the scanning angle.</li> <li>• Check the quality of the bar code label. Scan a bar code label that you know will scan. Compare the two bar code labels to see if the bar code quality is too low. You may need to replace the label that you cannot scan.</li> <li>• Make sure the bar code symbology is enabled and configured correctly. Use Intermec Settings to check the symbologies. Expand <b>Data Collection &gt; Symbologies</b> beneath devices listed (scanner, virtual wedge) to check and enable symbologies, then scan the bar code label again.</li> <li>• Make sure the computer application is expecting input from a bar code. You may need to type this information instead.</li> <li>• The scanner may not be turned on or the scanner may be unable to scan a specific bar code. Run the ScanDiagnostic application to help you troubleshoot the problem. For more information, see</li> </ul>
The scanner does not read the bar code labels quickly, or the scanning beam seems to be faint or obscured.	The scanner window may be dirty. Clean the window with a solution of ammonia and water. Wipe dry. Do not allow abrasive material to touch the window.
You scan a valid bar code label to enter data for your application. The data decoded by the scan module does not match the data encoded in the bar code label.	The computer may have decoded the bar code label in a symbology other than the label's actual symbology. Try scanning the bar code label again. Make sure you scan the entire label.
The input device attached to the computer does not work well or read bar code labels very quickly.	Set the Scanner Model command to the specific attached input device. Check enabled bar code symbologies and enable only the symbologies being used.

## Use ScanDiagnostic to Troubleshoot the Scanner

Use the ScanDiagnostic application to troubleshoot problems such as the inability to read a bar code or a scanner that does not turn on.

- 1 From the Home menu, tap **Start > ScanDiagnostic**.
- 2 From the Scan Health screen, select the scanner you want to troubleshoot and then tap **Diagnose**.

The application checks to make sure the scanner is enabled and checks settings to make sure they are optimized.

- 3 From the Scan Test screen, press and hold the **Press to Scan** button while aiming at the bar code you want to read.

After the computer scans the bar code, it beeps and the label data, data length, and symbology appear on the screen.

- 4 Press the right arrow button to view any recommended settings.
- 5 To accept the recommended settings, tap **Apply**.
- 6 Tap **OK** to exit.

## Troubleshoot Operating the Computer

Use this section to troubleshoot problems that may prevent you from being able to operate the computer.

### Problems Operating the Computer

Problem	Solution
You press the <b>Power</b> button and nothing happens.	Try the following solutions: <ul style="list-style-type: none"><li>• Replace or charge the battery. The battery may be completely drained.</li><li>• Remove the battery and press the <b>Reset</b> button to perform a cold boot. For help, see <b>“Cold Boot the Computer” on page 123</b>.</li></ul>

<b>Problem</b>	<b>Solution</b>
The computer appears to be locked up and you cannot enter data.	<ul style="list-style-type: none"> <li>• Press the <b>Power</b> button and select <b>Suspend</b> from the Power Options menu. Press the <b>Power</b> button to turn the screen back on.</li> <li>• Press the <b>Power</b> button and select <b>Reboot</b> from the Power Options menu.</li> <li>• Remove the battery and press the <b>Reset</b> button to perform a cold boot. For help, see “<b>Cold Boot the Computer</b>” on <a href="#">page 123</a>.</li> <li>• Try reloading the firmware. For help, see “<b>Update the System Software</b>” on <a href="#">page 110</a>.</li> <li>• If the computer does not boot or reset, contact your Intermec representative for help.</li> </ul>
The accelerometer does not appear to be accurate.	You may need to calibrate the accelerometer using the Sensor Calibration application. Tap <b>Start &gt; Settings &gt; System &gt; Sensor Calibration</b> . Rotate the computer to calibrate all six orientations.
You tap the screen and nothing happens.	Align your screen. For help, see “ <b>Align the Screen</b> ” on <a href="#">page 45</a> .
You cannot type a character on the keypad or you can only type uppercase or lowercase letters.	You may have locked a modifier key on the keypad. Press the necessary key sequence to unlock the key. For help, see “ <b>About the Keypad</b> ” on <a href="#">page 16</a> .

## **Call Product Support**

If you cannot find the answer to your problem in the “Troubleshooting the Computer” section, you can visit the Intermec technical knowledge base (Knowledge Central) at [intermec.custhelp.com](http://intermec.custhelp.com) to review technical information or to request technical support. If you still need help after visiting Knowledge Central, you may need to call Product Support.

To talk to an Intermec Product Support representative, call:

**1-800-755-5505**

Before you can call Intermec Product Support, make sure you have the following information ready:

- Configuration number
- Serial number
- Operating system version
- If you are using security, know the type (Funk or Microsoft) and the full set of parameters
- Power management settings
- If you are using Intermec Terminal Emulator (ITE), know the version and protocol. If you are not using ITE, know the language your custom application was written in and the tools you used to create it.

You can find most of the information listed above in Intermec Settings. Consult your application developer for information on your custom application.

## **Find Your Configuration Number**

Use the following procedure to help you find the configuration number of your computer.

- Look at the label on the back of the computer.



## Find Your Operating System Version

Use the following procedure to find the OS version of your mobile computer.

- 1 Press the **Intermec Dashboard** (📄) button to launch the Dashboard.
- 2 Tap the **Information** bar. The Information Details page appears and displays information such as the firmware version and the OS version.

## Reset the Computer

If the computer does not resume after pressing the **Power** button, or if the computer or an application locks up, you may need to reset the computer. The computer uses the configuration currently saved in flash memory during the boot process. There are three ways to reset the computer:

- Reboot
- Cold boot
- Clean boot

## Reboot the Computer

You may need to reboot the computer to correct conditions where an application stops responding to the system.

- Press the **Power** button and select **Reboot** from the menu.

The computer systematically shuts down, restarts, and goes through the initialization process.

## Cold Boot the Computer

In some cases where the computer completely stops responding, it may be necessary to perform a cold boot or hard reset. Because cold booting may result in data loss, use this method only if all other recovery methods have failed.



**Note:** Cold booting the computer does not guarantee that cached disk data will be saved, so transactional data may be lost during the reset. All other data, such as configuration and network settings, is preserved.

- 1 Press the **Power** button to suspend the computer.
- 2 Remove the handstrap and the battery pack.
- 3 Press the **Reset** button in the battery compartment on the back of the computer.

**Location of CN70/CN70e Reset Button**

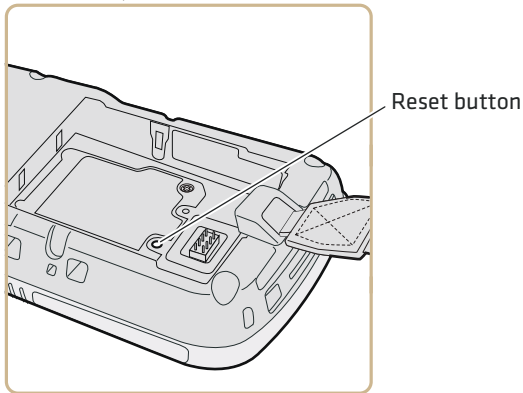

**Location of CK70/CK71 Reset Button**

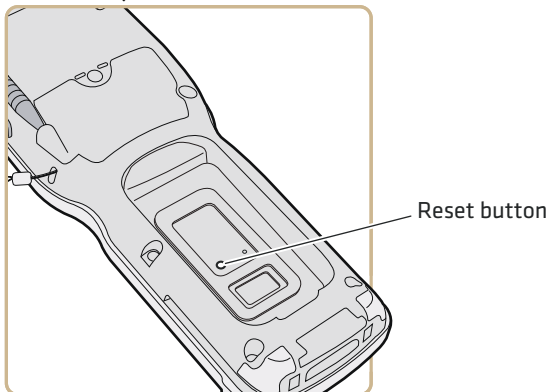

- 4 Replace the battery and the handstrap.
- 5 Press **Power** and wait while the mobile computer boots. When the cold boot is complete, the Home screen appears.

## Clean Boot the Computer



A clean boot erases the memory in the mobile computer, including all applications and data files, with the exception of those found in the Flash File Store, or any removable storage.

If the computer seems to be locked up, try cold booting it. If this process does not work, use a clean boot to get the computer up and running for further troubleshooting.

You can perform a clean boot using the mobile computer.



**Note:** You can also perform a clean boot using the SmartSystems Console. Right-click the 70 Series computer and select **Intermec Power Tools > Clean Boot Device**.

- 1 Remove the battery pack from the back of the computer.
- 2 With a stylus, press the **Reset** button in the battery cavity.
- 3 Insert the battery back into the computer, and immediately press and hold the **Power** button and **Volume Down** button (the lower button on the right side).
- 4 Continue to hold the **Power** button and the **Volume Down** button down until you are prompted to release them.
- 5 Press the **Volume Up** button on the right side to start the clean boot.
- 6 Wait for the computer to load files from its ROM.

## Clean the Computer

To keep the computer in good working order, you may need to clean the imager window, color camera window, and the touch screen. Clean the windows and the touch screen as often as needed for the environment in which you are using the computer. To clean the computer, use a solution of ammonia and water.



**There are no user-serviceable parts inside the 70 Series computer. Opening the computer will void the warranty and may cause damage to the internal components.**

## **Chapter 8 – Troubleshoot and Maintain the Computer**

- 1** Press the **Power** button and choose to suspend the computer.
- 2** Dip a clean cloth towel in the ammonia solution and wring out the excess.
- 3** Wipe off the imager window, camera lens, and flash area. Do not allow any abrasive material to touch these surfaces.
- 4** Wipe dry.

# A

## Specifications and Default Settings

# Physical and Environmental Specifications

## CN70 Physical Dimensions

Dimensions	16.9 x 8.0 x 3.4 cm (6.66 x 3.14 x 1.35 in)
Weight	450 g (15.2 oz) with battery

## CN70e Physical Dimensions

Dimensions	19.5 x 8.0 x 3.4 cm (7.66 x 3.14 x 1.35 in)
Weight	491 g (16.6 oz) with battery

## CK70 Physical Dimensions

Dimensions	23.7 x 8.0 x 4.3 cm (9.33 x 3.16 x 1.69 in)
Weight	562 g (19 oz) with battery

## CK71 Physical Dimensions

Dimensions	23.7 x 8.0 x 5.0 cm (9.33 x 3.16 x 1.98 in)
Weight	584 g (19.75 oz) with battery

## Environmental Specifications

Operating temperature	-20 °C to 60 °C (-4 °F to 140 °F)
Storage temperature	-30 °C to 70 °C (-22 °F to 158 °F)
Charging temperature	5 °C to 35 °C (41 °F to 95 °F)
Relative humidity (operating)	5% to 95% non-condensing
Environmental rating	IP67 compliant
Drop Specifications	All corners and sides from 1.8 m (6 ft) per MIL-STD 810F

## **Power and Electrical Specifications**

Battery type	Rechargeable Lithium-ion (Li-ion) battery
Battery capacity	
CN70/CN70e:	3.7 V, 4000 mAh (14.8 Wh)
CK70/CK71:	3.7 V, 5200 mAh (19.2 Wh)
Electrical rating	≡ 4.37/4.8 V; 2/1,5 A

## **70 Series Non-Incendive Computer Specifications**

The 70 Series mobile computers with non-incendive (NI) certification comply with the following specifications for North America and Canada regions only.

Location	Suitable for use in Division 2 locations
Safety	cULus Listing - ISA/ANSI 12.12.01
Gases	Class I - Groups A, B, C, D
Dusts	Class II - Groups F, G
Fibers and Flyings	Class III
Maximum Ambient Temperature	T6 rating with a maximum temperature of 50 °C

## **Operating System**

Microsoft Windows Embedded Handheld.

## Hardware

Main processor options	TI OMAP3, 1 GHz TI OMAP3, 600 MHz
Memory	512 MB RAM
Persistent storage	1 GB Flash
Removable storage	up to 32 GB user-accessible microSD card slot
Keypad	CN70: QWERTY, Numeric CN70e: QWERTY Numeric, Numeric, Calculator-style CK70: Large Alpha, Alphanumeric CK71: Numeric Function, Alphanumeric
Imaging options	5 megapixel color camera and EA30 area imager (all), EV12 (CK71 only), or EX25 (CK71 only)

## Back Accessory Interface Pin-outs

The back accessory interface provides power for peripheral devices out the back of the CK70 and CK71 computers.

Pin	Pin Name	I/O	Description
1	OTB_PWR	Output	Power supply for peripheral
2	GND		
3	OTB_RX	Input	DTE Data Receive
4	OTB_TX	Output	DTE Data Transmit
5	OTB_I/O_Voltage	Input	I/O Voltage Level
6	OTB_ID	BiDir	One Wire Bus for ID
7	OTB_RTS	Output	DTE Ready to Send
8	OTB_CTS	Input	DTE Clear to Send

## Touch Screen Specifications

Transmissive VGA display with high-durability touch screen; 480 x 640 pixels; 8.9 cm (3.5 in) diagonal active area; LED backlight and ambient light sensor.



## **Standard Communications**

- UMTS (not available on CK71)
- CDMA (not available on CK71)
- Flexible Network Radio (not available on CK71)
- GPS (not available on CK71)
- 802.11a/b/g/n
- Bluetooth
- USB Full Speed V2.0 Host
- USB Full Speed V2.0 Client

## **Wireless LAN**

Standards compliant	IEEE 802.11a/b/g/n (2.4 GHz and 5 GHz), Single Stream
Data rates	up to 72Mbps
Security	802.11i, WPA, WPA2, 802.1x (EAP-TLS, TTLS, PEAP, EAP-FAST), WEP
Certifications	WPA2™ (Enterprise, Personal), WPA™ (Enterprise, Personal), Wi-Fi, WMM®, WMM Power Save, Cisco Compatible Extensions (CCX 4.0)

## **Regulatory Approvals**

FCC, CE, cULus Listed, DEMKO

## **Bar Code Symbolologies**

The imagers support all of the bar code symbolologies listed in the next table.

### **Supported Bar Code Symbolologies**

AustraliaPost*	GS1 DataBar Omni-Directional
Aztec*	Infomail*
BPO*	Interleaved 2 of 5
Canada Post*	Japan Post*
China Post*	KoreanPost*
Codabar	Matrix 2 of 5
Codablock A*	Maxicode*
Codablock F*	Micro PDF417*
Code 11	MSI
Code 39	PDF417*
Code 93	Planet*
Code 128/GS1-128	Plessey
DataMatrix*	Postnet*
Dutch Post*	QR Code*
EAN/UPC	Standard 2 of 5
GS1 Composite	SwedenPost*
GS1 DataBar Expanded	Telepen
GS1 DataBar Limited	TLC 39*

\* These symbolologies are not supported with the EV12 imager in the CK71.

## **Imager Reading Distances**

Typical reading distances are done in an office environment using office lights (4 lux). Minimum distances are measured in the dark (0 lux). Both reading distances are provided in respective scan engine integration guides. Contact your local Intermec representative for more information.

Below are the typical and minimum standard reading distances for the 70 Series computer built with an EA30 imager. Also included are typical and minimum standard reading distances for the CK71 with an EV12 or EX25 imager.



**Note:** Minimum distances depend on the length of the bar code.

## EA30 Typical Reading Distances - Extended Reading Range

These typical reading distances are measured in an office environment (250 lux) for the EA30 standard model with Extended Reading Range activated. Extended Reading Range is enabled by default.

**EA30 Typical Reading Distances - Extended Reading Range Activated**

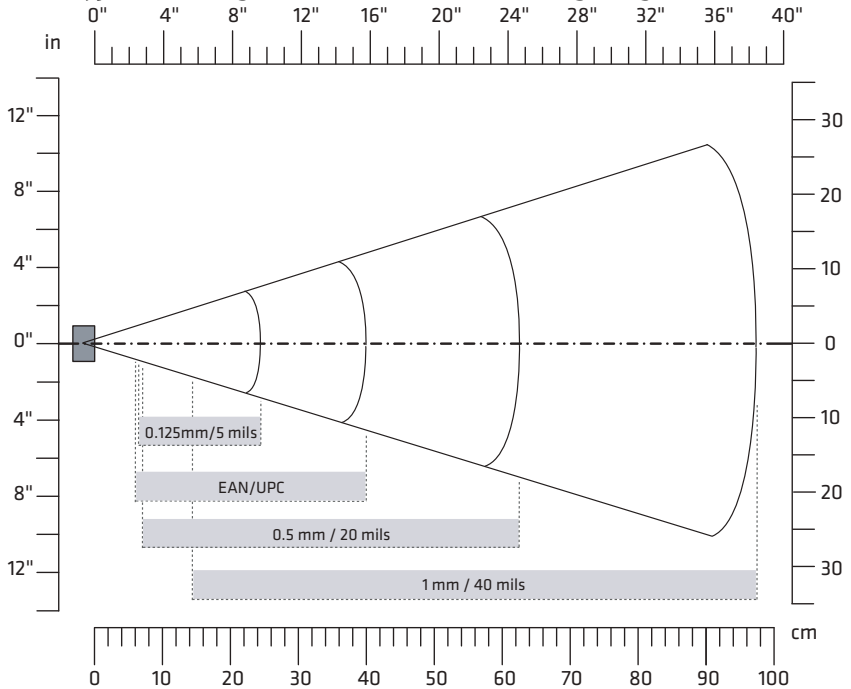

**EA30 Typical Reading Distances - Extended Reading Range Activated**

Symbology	Density	Minimum Distance	Maximum Distance
Code 39	0.125 mm/5 mils	64.50 cm/2.56 in	24.50 cm/9.65 in
	0.50 mm/20 mils	7 cm/ 2.76 in	62.50 cm/24.61 in
	1 mm/40 mils	14.50 cm/5.71 in	97.50 cm/38.39 in
EAN/UPC 100%	0.33 mm/13 mils	6 cm/2.36 in	40 cm/15.75 in

## EA30 Area Imager Minimum Reading Distances

Minimum distances are measured in the dark (0 lux).

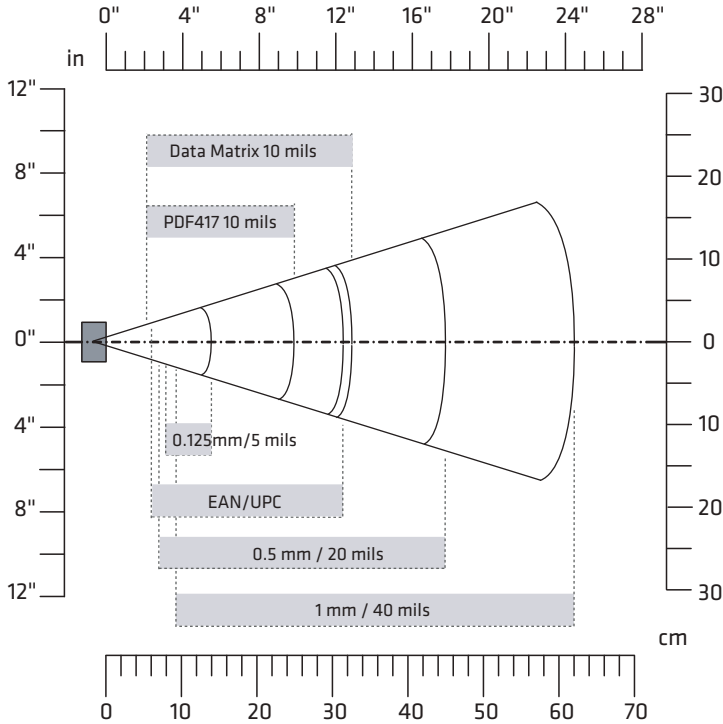

### EA30 Minimum Reading Distances

Symbology	Density	Minimum Distance	Maximum Distance
Code 39	0.1 mm (4 mils)	9.5 cm (3.74 in)	10.5 cm (4.13 in)
	0.1250 mm (5 mils)	8 cm (3.15 in)	14 cm (5.51 in)
	0.5 mm (20 mils)	7 cm (2.76 in)	45 cm (17.72 in)
	1 mm (40 mils)	9.5 cm (3.74 in)	62 cm (24.41 in)
UPC/EAN 100%	0.33 mm (13.0 mils)	6 cm (2.36 in)	31.5 cm (12.4 in)
Data Matrix	0.18 mm (7 mils)	8 cm (3.15 in)	15.5 cm (6.1 in)
	0.25 mm (10 mils)	6.5 cm (2.56 in)	21.5 cm (8.46 in)
	0.38 mm (15 mils)	5.5 cm (2.17 in)	31.5 cm (12.4 in)
PDF417	0.25 mm (10 mils)	5.5 cm (2.17 in)	25 cm (9.84 in)
	038 mm (15 mils)	7 cm (2.76 in)	34 cm (13.39 in)

## EA30 Area Imager Typical Reading Distances

Typical distances are measured in an office environment (250 lux).

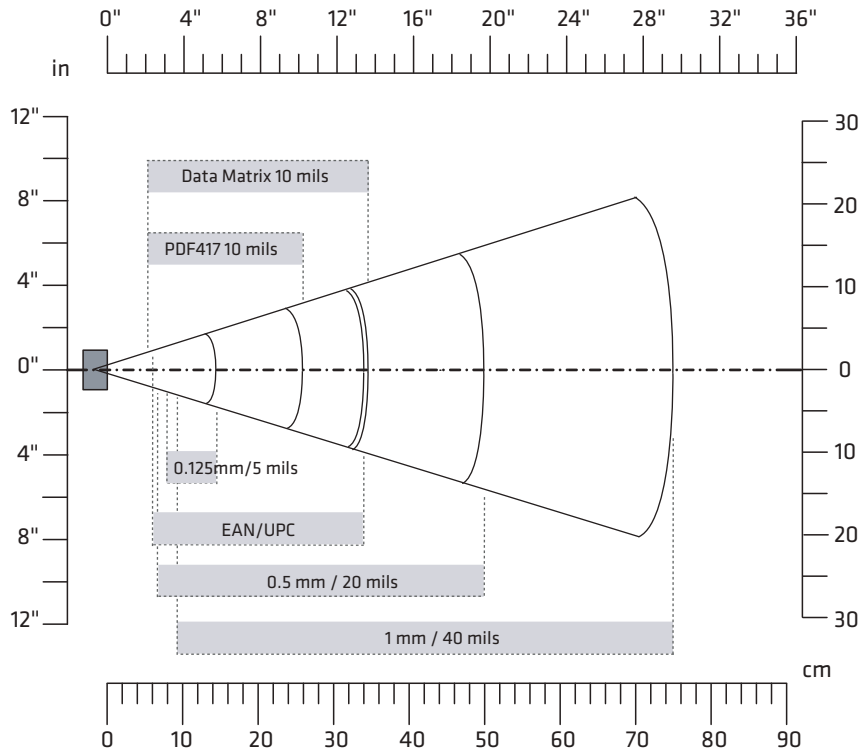

### EA30 Typical Reading Distances

Symbology	Density	Minimum Distance	Maximum Distance
Code 39	0.1 mm (4 mils)	9.5 cm (3.74 in)	11.5 cm (4.53 in)
	0.125 mm (5 mils)	8 cm (3.15 in)	14.5 cm (5.71 in)
	0.5 mm (20 mils)	6.5 cm (2.56 in)	50 cm (19.69 in)
	1 mm (40 mils)	9.5 cm (3.74 in)	75 cm (29.53 in)
UPC/EAN 100%	0.33 mm (13.0 mils)	6 cm (2.36 in)	34 cm (13.39 in)
Data Matrix	0.18 mm (7 mils)	7.5 cm (2.95 in)	16.5 cm (6.5 in)
	0.25 mm (10 mils)	6 cm (2.36 in)	23 cm (9.06 in)
	0.38 mm (15 mils)	5.5 cm (2.17 in)	34.5 cm (13.58 in)
PDF417	0.25 mm (10 mils)	5.5 cm (2.17 in)	26 cm (10.24 in)
	0.38 mm (15 mils)	6.5 cm (2.56 in)	37 cm (14.57 in)

## EV12 Linear Imager Minimum Reading Distances

The illustration below does not include the 0.12 cm (0.05 in) setback for the CK71. Minimum reading distances are measured in the dark (0 lux).

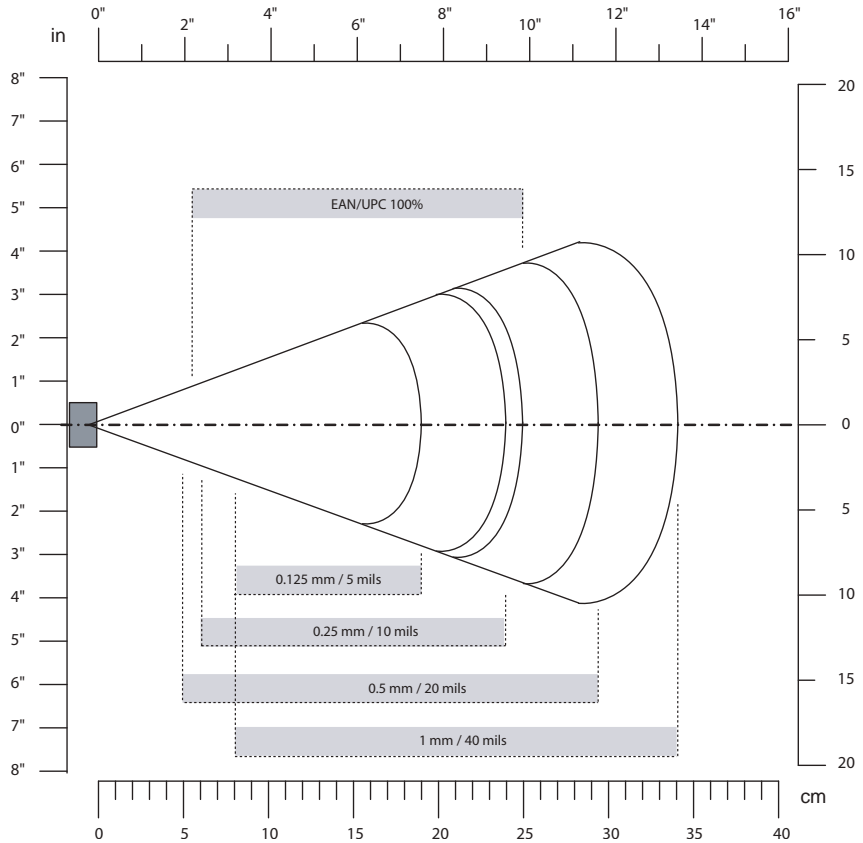

### EV12 Minimum Reading Distances With 0.12 cm (0.05 in) Setback

Symbology	Density	Minimum Distance	Maximum Distance
Code 39	0.15 mm (6 mils)	9.6 cm (3.8 in)	17.9 cm (7.1 in)
	0.25 mm (10 mils)	7.1 cm (2.9 in)	20.9 cm (8.3 in)
	0.5 mm (20 mils)	6.1 cm (2.5 in)	26.9 cm (10.6 in)
	1 mm (40 mils)	8.1 cm (3.2 in)	33.9 cm (13.4 in)
EAN/UPC	0.33 mm (13 mils)	6.1 cm (2.5 in)	22.9 cm (9.1 in)

## EV12 Linear Imager Typical Reading Distances

The illustration below does not include the 0.12 cm (0.05 in) setback for the CK71. Typical reading distances are measured in an office environment (200 lux).

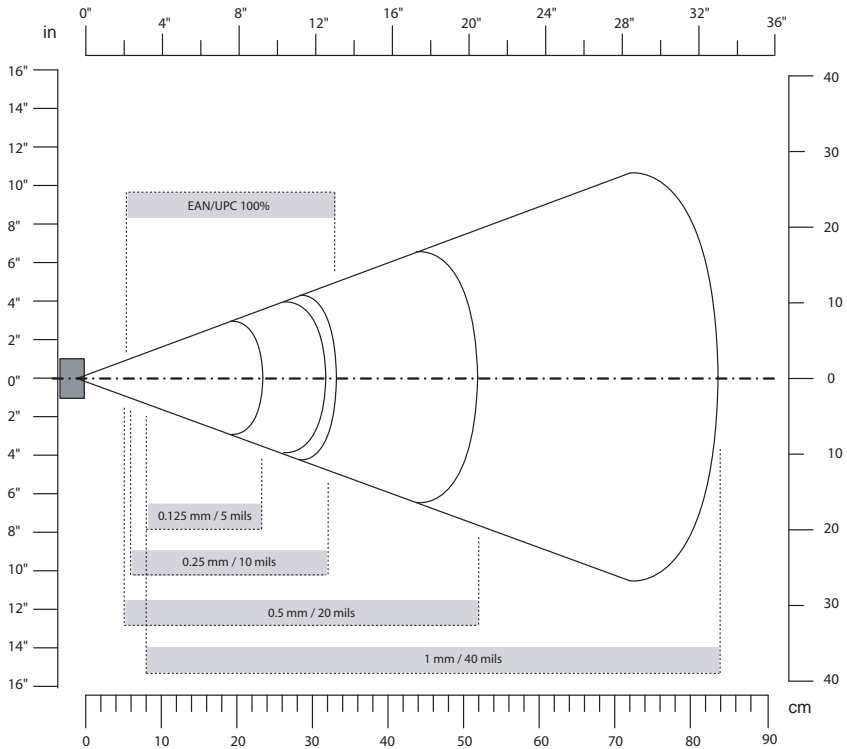

### EV12 Typical Reading Distances With 0.12 cm (0.05 in) Setback

Symbology	Density	Minimum Distance	Maximum Distance
Code 39	0.15 mm (6 mils)	9.6 cm (3.8 in)	19.9 cm (7.9 in)
	0.25 mm (10 mils)	6.1 cm (2.5 in)	24.9 cm (9.8 in)
	0.5 mm (20 mils)	5.1 cm (2.1 in)	34.9 cm (13.8 in)
	1 mm (40 mils)	7.1 cm (2.9 in)**	50.9 cm (20.1 in)
EAN/UPC	0.33 mm (13 mils)	5.1 cm (2.1 in)	27.9 cm (11.0 in)

\*\* Minimum distance depends on bar code width and scan angle.



## EX25 Near-Far Range Imager Minimum Reading Distance

Minimum reading distances are measured in the dark (0 lux). The following graphic does not include the 0.24 cm (0.09 in) setback for the CK71.

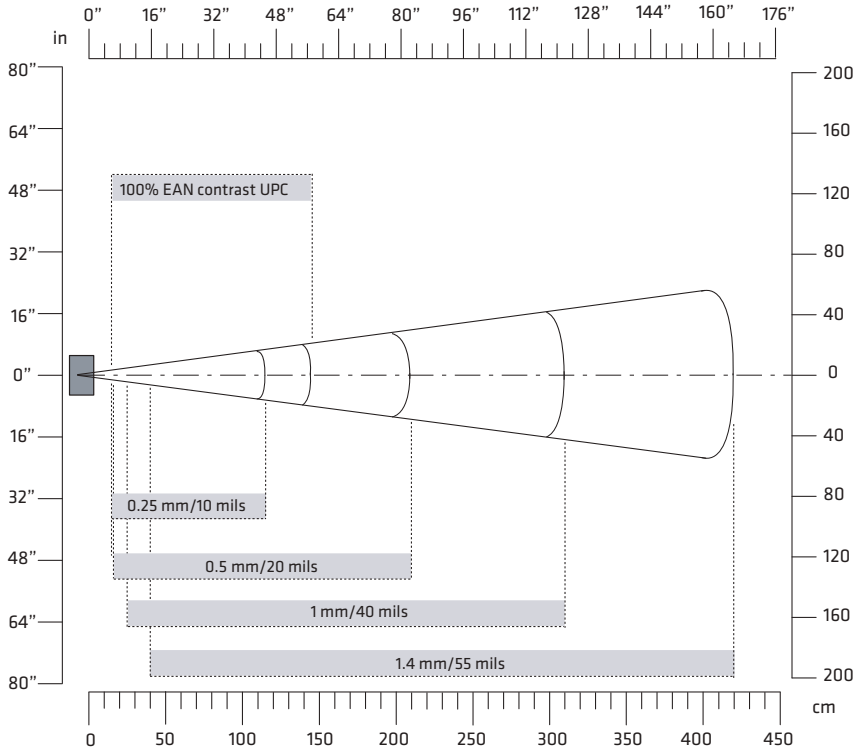

**EX25 Minimum Reading Distances With 0.24 cm (0.09 in) Setback**

Symbology	Density	Minimum Distance	Maximum Distance
Code 39	0.08 mm (3 mils)	15 cm (5.91 in)	35 cm (13.78 in)
	0.1 mm (2.8 mils)	15 cm (5.91 in)	45 cm (17.72 in)
	0.25 mm (10 mils)	15 cm (5.91 in)	115 cm (45.28 in)
	0.5 mm (20 mils)	16 cm (6.30 in)	210 cm (82.68 in)
	1 mm (40 mils)	25 cm (9.84 in)	310 cm (122.05 in)
	1.3 mm (51 mils)	40 cm (15.75 in)	310 cm (122.05 in)
EAN 100%	0.33 mm (13 mils)	15 cm (5.91 in)	145 cm (57.09 in)

## EX25 Near-Far Range Imager Typical Reading Distance

Typical reading distances are measured in an office environment (200 lux). The following graphics do not include the 0.24 cm (0.09 in) setback for the CK71.

### EX25 Near-Far Range Imager 1D Typical Reading Distances

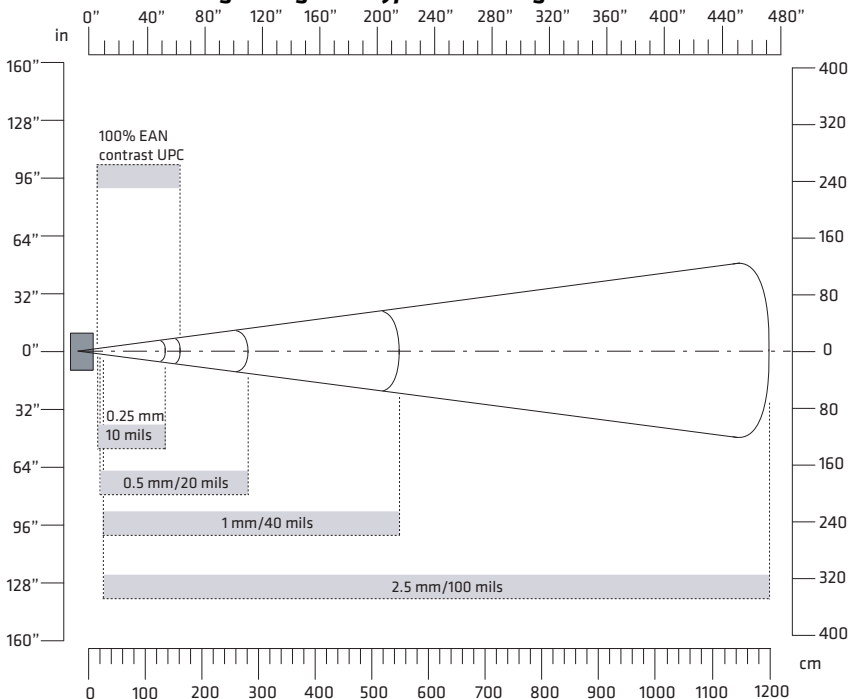

**EX25 1D Symbologies Typical Reading Distances With 0.24 cm (0.09 in) Setback**

Symbology	Density	Minimum Distance	Maximum Distance
Code 39	0.25 mm (10 mils)	15 cm (5.91 in)	135 cm (53.15 in)
	0.5 mm (20 mils)	16 cm (6.30 in)	280 cm (110.24 in)
	1 mm (40 mils)	25 cm (9.84 in)	550 cm (216.54 in)
	1.4 mm (55 mils)	40 cm (15.75 in)	720 cm (283.46 in)
	2.5 mm (100 mils)	**	1200 cm (472.44 in)
Code 128 retro-reflective	2.5 mm (100 mils)	**	1300 cm (511.81 in)
EAN 100%	0.33 mm (13 mils)	15 cm (5.91 in)	160 cm (62.99 in)

\*\* Minimum distance depends on bar code width and scan angle.

**EX25 Near-Far Range Imager 2D Typical Reading Distances**

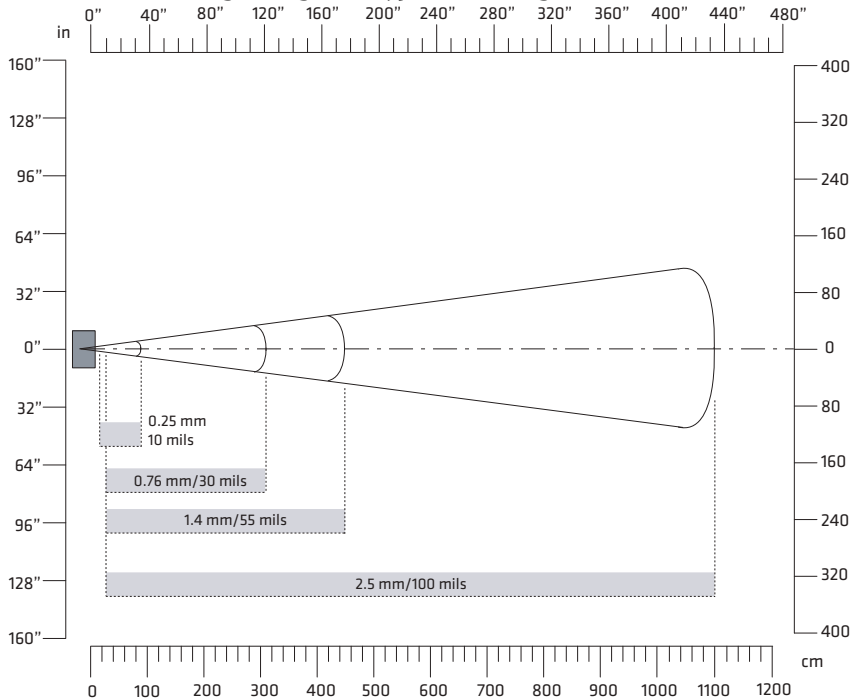

**EX25 2D Symbologies Typical Reading Distances With 0.24 cm (0.09 in) Setback**

Symbology	Density	Minimum Distance	Maximum Distance
DataMatrix	0.25 mm (10 mils)	15 cm (5.91 in)	90 cm (35.43 in)
	0.76 mm (30 mils)	25 cm (9.84 in)	310 cm (122.05 in)
	1.4 mm (55 mils)	**	450 cm (177.17 in)
	2.5 mm (100 mils)	**	1100 cm (433.07 in)
	7.5 mm (300 mils)	20 cm (7.87 in)	1524 cm (600 in)

\*\* Minimum distance depends on bar code width and scan angle.

## Default Configuration

The following tables list the default values of the configuration settings supported on the mobile computer. If you restore the mobile computer to factory default settings, the mobile computer uses these values.

The settings are grouped by function and reflect the organization of Intermec Settings. Not all of the configuration settings are listed in this appendix. For detailed information on most of the settings, see the *Intermec Settings Command Reference Manual*.

## Data Collection Settings

Use data collection settings to configure the imager and to configure the bar codes that you want the imager to be able to read.

### Data Collection Settings

Data Collection Setting	Default Value
Enable Scanner/Camera Port	On
BT-Configure On Connect	Overwrite with computer settings
Enable Magstripe Reader	Disable

**Symbology Settings**

<b>Symbology</b>	<b>Default Value</b>
AustraliaPost	Disable
Aztec	Disable
BPO	Disable
CanadaPost	Disable
Codabar	Disable
Codablock A	Disable
Codablock F	Disable
Code 11	Disable
Code 39	Enable
Code 93	Disable
Code 128/GS1-128	Enable
DataMatrix	Enable
DutchPost	Disable
EAN/UPC	Enable UPC A, UPC E, EAN 8, EAN 13
GS1 Composite	Disable
GS1 DataBar Expanded	Disable
GS1 DataBar Limited	Disable
GS1 DataBar Omni-Directional	Disable
Infomail	Disable
Intelligent Mail	Disable
Interleaved 2 of 5	Disable
JapanPost	Disable
Matrix 2 of 5	Disable
Maxicode	Disable
Micro PDF417	Disable
MSI	Disable
PDF417	Enable
Planet	Disable
Plessey	Disable
Postnet	Disable
QR Code	Disable

## Appendix A – Specifications and Default Settings

<b>Symbology</b>	<b>Default Value</b>
Standard 2 of 5	Disable
SwedenPost	Disable
Telepen	Disable
TLC 39	Disable

### **Symbology Option Settings**

<b>Symbology Option Settings</b>	<b>Default Value</b>
Preamble	None (Disabled)
Postamble	None (Disabled)
Symbology Identifier	Disable
Multicode	Disable

### **Scanner Settings**

<b>Scanner Settings</b>	<b>Default Value</b>
Trigger Predefined Modes	Level
Trigger Mode	Level
Aimer Mode	Typical aimer
Hardware Trigger	Enable
Trigger Timeout (sec)	2
Aiming Duration (msec)	500
Turn Off After Good Read	Enable/One-shot
Auto-Trigger delay (msec)	0

### **Imager Settings**

<b>Imager Settings</b>	<b>Default Value</b>
Predefined Modes	1D and 2D Standard
Image File Location	\\My Documents\\MDI
Signature Image Capture	Disable
Document Imaging	Disable

<b>Imager Settings</b>	<b>Default Value</b>
Image Capture	
Output Compression	Bitmap
Output Compression Quality	0
Edge Enhancement	None
Noise Reduction	0
Subsampling	None
Image Rotation	None
Image Lighting Correction	Disable

***Decode Security Settings***

<b>Decode Security Settings</b>	<b>Default Value</b>
Consecutive Data Validation	0
Identical Consecutive Timeout	300 ms
Different Consecutive Timeout	0
Center Decoding	Disable
Center Decoding Tolerance	0

## **Communications**

Use communications settings to configure how the mobile computer communicates with the network.

***Communications Settings***

<b>Communications Setting</b>	<b>Default Value</b>
Device Name	IntermecCXXX (where XXX indicates the model of mobile computer)

***802.11 Radio Settings***

<b>802.11 Radio Setting</b>	<b>Default Value</b>
Security Choice	Funk
Allow Security Changes	Enabled
Active Profile	Profile 1
DHCP	Enabled
Import Root Certificates	False

## Appendix A – Specifications and Default Settings

<b>802.11 Radio Setting</b>	<b>Default Value</b>
Import User Certificates	False
Import Pac Files	False
Radio Bands	b/g (2.4 GHz)
Radio Enabled	Off

### ***Ethernet Adapter Settings***

<b>Ethernet Adapter Setting</b>	<b>Default Value</b>
DHCP	Enabled

### ***Bluetooth Settings***

<b>Bluetooth Setting</b>	<b>Default Value</b>
Bluetooth Power	Off

### ***WWAN Radio Settings***

<b>WWAN Radio Setting</b>	<b>Default Value</b>
WWAN Radio Enabled	Enabled

### ***Serial Port Switch***

<b>Serial Port Switch Setting</b>	<b>Default Value</b>
Serial Port Switch	Standard Docking and IrDA

## **Device Settings**

Use device settings to configure settings on the mobile computer.

### **Device Settings**

<b>Device Setting</b>	<b>Default Value</b>
Date	N/A
Time	N/A



### Good Read Settings

Good Read Setting	Default Value
Internal Scanner Good Read Beep	One Beep
Tethered Scanner	One Beep
Bluetooth Scanner Good Read Beep	One Beep

### Backlight Settings

Backlight Setting	Default Value
Display Backlight Adjustment	Normal
Keypad Backlight	On Based on Light Level
Light Level	Low

### Screen Settings

Screen Setting	Default Value
Screen Rotations	Portrait 0 Degrees
Screen Rotation Sensor	Disabled

### Sound Settings

Sound Setting	Default Value
Beeper and Voice	Medium
Headset Beeper	Very Low
Vibrate Mode Intensity	1 Strong Pulse
Screen Taps	Off
Key Clicks	Off

### Keypad Settings

Keypad Setting	Default Value
Button Remapping	Scanner

**Power Management Settings**

<b>Power Management Setting</b>	<b>Default Value</b>
Enable Power Button Screen	On
Screen Options Displayed	Hibernate, Suspend, Reboot
Screen Timeout (Seconds)	5
Power Button Behavior	Suspend
Device Turns Off After (Battery Power)	5 minutes
Screen Turns Off After (Battery Power)	Disabled
Device Turns Off After (External Power)	Disabled
Screen Turns Off After (External Power)	Disabled
Device Off Sensor	Disabled

**Profiles Settings Application**

<b>Profiles Settings</b>	<b>Default Value</b>
Camera	
Disable Camera Scan	Show Option in Profile Settings
Enable Camera Scan	Show Option in Profile Settings
Power	
Always On	Show Option in Profile Settings
Maximize Battery Life	Show Option in Profile Settings
Normal	Show Option in Profile Settings
Scanning	
1D Bar Codes Optimized	Show Option in Profile Settings
Bright Sunlight	Show Option in Profile Settings
Reflective Labels	Show Option in Profile Settings
Standard	Show Option in Profile Settings

## GPS Settings

Use GPS settings to configure how the mobile computer communicates with the GPS network.

### *GPS*

GPS Setting	Default Value
Enable Bread Crumbing	Disable

## Core Messaging Service Settings

Use core messaging service settings to configure the message routers between client and server software applications.

### *Core Messaging Service*

Core Messaging Service Setting	Default Value
Associated Server IP	Null
Broadcast Name	INTERMEC
Port	62241
Keep Alive Ping Interval	30 Seconds

## Device Monitor Settings

Use device monitor settings to configure how the mobile computer monitors the network.

### *Device Health Controls*

Device Health Setting	Default Value
Enable Health Data Collection	On
Enable Device Health Application	On
Enable Blue Light	Off for Ready-to-Work
Set Rule File Location	\\SmartSystems\HealthRules.txt
System Device Health Refresh (seconds)	90
Network Device Health Refresh (seconds)	45

***Device Health Screen Captures***

<b>Device Health Screen Captures Setting</b>	<b>Default Value</b>
Directory	\\SmartSystems\\ScreenCapture
Screen Captures Allowed	3

***Device Wipe***

<b>Device Wipe Setting</b>	<b>Default Value</b>
Enable Wipe	Disabled
Interval (in days)	Null

## **Virtual Wedge Settings**

Use virtual wedge settings to configure the virtual wedge.

***Virtual Wedge Setting***

<b>Setting</b>	<b>Default Value</b>
Virtual Wedge	Enable
Bar Code Scanner Grid	Null
Label Encoding (Code Page)	1252
Magstripe Reader Grid	Null

# B

## Keypads and Keystrokes

# Standard Characters

Use the following tables to learn how to enter standard and other available characters and functions with the keypad. If there is no sequence of keystrokes for a particular character or function, it is only available through the soft input panel (SIP), which you can access by tapping the keyboard icon on the touch screen.



**Note:** You can only enter “\*” and “#” characters in the phone or contacts applications.







































## CN70 Keypads and Keystrokes

### CN70 Alphanumeric Characters

Character	Numeric Keypad	QWERTY Keypad
a	2	A
b	2  2	B
c	2  2  2	C
d	3	D
e	3  3	E
f	3  3  3	F
g	4	G
h	4  4	H
i	4  4  4	I
j	5	J
k	5  5	K
l	5  5  5	L
m	6	M

Character	Numeric Keypad	QWERTY Keypad
n	6 6	N
o	6 6 6	O
p	7	P
q	7 7	Q
r	7 7 7	R
s	7 7 7 7	S
t	8	T
u	8 8	U
v	8 8 8	V
w	9	W
x	9 9	X
y	9 9 9	Y
z	9 9 9 9	Z
A	1 2	A
B	1 2 2	B
C	1 2 2 2	C
D	1 3	D
E	1 3 3	E
F	1 3 3 3	F
G	1 4	G
H	1 4 4	H

## Appendix B – Keypads and Keystrokes

Character	Numeric Keypad	QWERTY Keypad
I	 <b>1</b> <b>4</b> <b>4</b> <b>4</b>	 <b>I</b>
J	 <b>1</b> <b>5</b>	 <b>J</b>
K	 <b>1</b> <b>5</b> <b>5</b>	 <b>K</b>
L	 <b>1</b> <b>5</b> <b>5</b> <b>5</b>	 <b>L</b>
M	 <b>1</b> <b>6</b>	 <b>M</b>
N	 <b>1</b> <b>6</b> <b>6</b>	 <b>N</b>
O	 <b>1</b> <b>6</b> <b>6</b> <b>6</b>	 <b>O</b>
P	 <b>1</b> <b>7</b>	 <b>P</b>
Q	 <b>1</b> <b>7</b> <b>7</b>	 <b>Q</b>
R	 <b>1</b> <b>7</b> <b>7</b> <b>7</b>	 <b>R</b>
S	 <b>1</b> <b>7</b> <b>7</b> <b>7</b> <b>7</b>	 <b>S</b>
T	 <b>1</b> <b>8</b>	 <b>T</b>
U	 <b>1</b> <b>8</b> <b>8</b>	 <b>U</b>
V	 <b>1</b> <b>8</b> <b>8</b> <b>8</b>	 <b>V</b>
W	 <b>1</b> <b>9</b>	 <b>W</b>
X	 <b>1</b> <b>9</b> <b>9</b>	 <b>X</b>
Y	 <b>1</b> <b>9</b> <b>9</b> <b>9</b>	 <b>Y</b>
Z	 <b>1</b> <b>9</b> <b>9</b> <b>9</b> <b>9</b>	 <b>Z</b>
0	<b>0</b>	 <b>,</b>
1	<b>1</b>	 <b>Y</b>
2	<b>2</b>	 <b>U</b>

















































Character	Numeric Keypad	QWERTY Keypad
3		
4		
5		
6		
7		
8		
9		

**CN70 Characters and Functions**

To Enter	Numeric Keypad	QWERTY Keypad
@ (at symbol)	N/A	
& (ampersand)	N/A	
* (asterisk)		
: (colon)	N/A	
, (comma)	N/A	
\$ (dollar)	N/A	
! (exclamation)	N/A	
- (hyphen)		
% (percent)	N/A	
. (period)		
+ (plus)		
# (pound)		

## Appendix B – Keypads and Keystrokes

To Enter	Numeric Keypad	QWERTY Keypad
? (question mark)	N/A	 
‘ (apostrophe)	N/A	 
Forward Tab		
Backspace		
Up Arrow		
Down Arrow		
Left Arrow		
Right Arrow		
CapsLock	 	 
Enter		
ok	 	 
Shift	 or 	 or 
Space	 	
Start (Windows)	  or  	 
Esc		
Talk		
End Call		
Intermec Dashboard		

# CN70e Keypads and Keystrokes

## CN70e Alphanumeric Characters

Character	Numeric Keypad	Calculator-Style Keypad	QWERTY Numeric Keypad
a	2	8	A
b	2  2	8  8	B
c	2  2  2	8  8  8	C
d	3	9	D
e	3  3	9  9	E
f	3  3  3	9  9  9	F
g	4	4	G
h	4  4	4  4	H
i	4  4  4	4  4  4	I
j	5	5	J
k	5  5	5  5	K
l	5  5  5	5  5  5	L
m	6	6	M
n	6  6	6  6	N
o	6  6  6	6  6  6	O
p	7	1	P
q	7  7	1  1	Q
r	7  7  7	1  1  1	R
s	7  7  7  7	1  1  1  1	S

## Appendix B – Keypads and Keystrokes

Character	Numeric Keypad	Calculator-Style Keypad	QWERTY Numeric Keypad
t	8	2	T
u	8 8	2 2	U
v	8 8 8	2 2 2	V
w	9	3	W
x	9 9	3 3	X
y	9 9 9	3 3 3	Y
z	9 9 9 9	3 3 3 3	Z
A	1 2	7 8	A
B	1 2 2	7 8 8	B
C	1 2 2 2	7 8 8 8	C
D	1 3	7 9	D
E	1 3 3	7 9 9	E
F	1 3 3 3	7 9 9 9	F
G	1 4	7 4	G
H	1 4 4	7 4 4	H
I	1 4 4 4	7 4 4 4	I
J	1 5	7 5	J
K	1 5 5	7 5 5	K
L	1 5 5 5	7 5 5 5	L
M	1 6	7 6	M
N	1 6 6	7 6 6	N

Character	Numeric Keypad	Calculator-Style Keypad	QWERTY Numeric Keypad
O	1 6 6 6	7 6 6 6	O
P	1 7	7 1	P
Q	1 7 7	7 1 1	Q
R	1 7 7 7	7 1 1 1	R
S	1 7 7 7 7	7 1 1 1 1	S
T	1 8	7 2	T
U	1 8 8	7 2 2	U
V	1 8 8 8	7 2 2 2	V
W	1 9	7 3	W
X	1 9 9	7 3 3	X
Y	1 9 9 9	7 3 3 3	Y
Z	1 9 9 9 9	7 3 3 3 3	Z
0	0	0	0
1	1	1	1
2	2	2	2
3	3	3	3
4	4	4	4
5	5	5	5
6	6	6	6

## Appendix B – Keypads and Keystrokes

Character	Numeric Keypad	Calculator-Style Keypad	QWERTY Numeric Keypad
7			
8			
9			

### CN70e Characters and Functions

To Enter	Numeric Keypad	Calculator-Style Keypad	QWERTY Numeric Keypad
@ (at symbol)	N/A	N/A	
& (ampersand)	N/A	N/A	
* (asterisk)			
: (colon)	N/A	N/A	
, (comma)	N/A	N/A	
\$ (dollar)	N/A	N/A	
! (exclamation)	N/A	N/A	
- (hyphen)			
% (percent)	N/A	N/A	
. (period)			
+ (plus)			
# (pound)			
? (question mark)	N/A	N/A	
' (apostrophe)	N/A	N/A	
Forward Tab			
Backspace			

To Enter	Numeric Keypad	Calculator-Style Keypad	QWERTY Numeric Keypad
Up Arrow			
Down Arrow			
Left Arrow			
Right Arrow			
CapsLock			
Enter			
ok			
Shift	or	or	or
Space			
Start (Windows)	or	or	
Esc			
Talk			
End Call			
Intermec Dashboard			

## CK70 Keypads and Keystrokes

















































































### CK70 Alphanumeric Characters

Character	Large Alpha Keypad	Alphanumeric Keypad
a		
b		
c		

























## Appendix B – Keypads and Keystrokes

Character	Large Alpha Keypad	Alphanumeric Keypad
d	<b>D</b>	<b>D</b>
e	<b>E</b>	<b>E</b>
f	<b>F</b>	<b>F</b>
g	<b>G</b>	<b>G</b>
h	<b>H</b>	<b>H</b>
i	<b>I</b>	<b>I</b>
j	<b>J</b>	<b>J</b>
k	<b>K</b>	<b>K</b>
l	<b>L</b>	<b>L</b>
m	<b>M</b>	<b>M</b>
n	<b>N</b>	<b>N</b>
o	<b>O</b>	<b>O</b>
p	<b>P</b>	<b>P</b>
q	<b>Q</b>	<b>Q</b>
r	<b>R</b>	<b>R</b>
s	<b>S</b>	<b>S</b>
t	<b>T</b>	<b>T</b>
u	<b>U</b>	<b>U</b>
v	<b>V</b>	<b>V</b>
w	<b>W</b>	<b>W</b>
x	<b>X</b>	<b>X</b>



Character	Large Alpha Keypad	Alphanumeric Keypad
y		
z		
A	 	 
B	 	 
C	 	 
D	 	 
E	 	 
F	 	 
G	 	 
H	 	 
I	 	 
J	 	 
K	 	 
L	 	 
M	 	 
N	 	 
O	 	 
P	 	 
Q	 	 
R	 	 
S	 	 

## Appendix B – Keypads and Keystrokes























































Character	Large Alpha Keypad	Alphanumeric Keypad
T	 <b>T</b>	 <b>T</b>
U	 <b>U</b>	 <b>U</b>
V	 <b>V</b>	 <b>V</b>
W	 <b>W</b>	 <b>W</b>
X	 <b>X</b>	 <b>X</b>
Y	 <b>Y</b>	 <b>Y</b>
Z	 <b>Z</b>	 <b>Z</b>
0	 <b>P</b>	<b>0</b>
1	 <b>D</b>	<b>1</b>
2	 <b>E</b>	<b>2</b>
3	 <b>F</b>	<b>3</b>
4	 <b>G</b>	<b>4</b>
5	 <b>H</b>	<b>5</b>
6	 <b>I</b>	<b>6</b>
7	 <b>K</b>	<b>7</b>
8	 <b>L</b>	<b>8</b>
9	 <b>M</b>	<b>9</b>























### CK70 Characters and Functions

To Enter	Large Alpha Keypad	Alphanumeric Keypad
@ (at symbol)	 <b>S</b>	N/A
& (ampersand)	 <b>W</b>	 <b>U</b>







































To Enter	Large Alpha Keypad	Alphanumeric Keypad
* (asterisk)	<b>O</b>	<b>0</b>
: (colon)	<b>J</b>	<b>2</b>
; (semicolon)	<b>J</b>	<b>5</b>
, (comma)	<b>T</b>	<b>X</b>
\$ (dollar)	<b>S</b>	N/A
! (exclamation)	<b>W</b>	N/A
- (hyphen or minus)	<b>X</b>	<b>Space</b>
% (percent)	<b>O</b>	N/A
. (period)	<b>.</b>	<b>.</b>
+ (plus)	<b>X</b>	<b>Space</b>
# (pound)	<b>Q</b>	<b>0</b>
? (question mark)	<b>Q</b>	<b>Y</b>
' (apostrophe)	<b>T</b>	<b>Y</b>
= (equals)	<b>Y</b>	<b>S</b>
_ (underscore)	<b>Y</b>	<b>X</b>
> (greater than)	<b>N</b>	<b>V</b>
< (less than)	<b>N</b>	<b>V</b>
[ (left square bracket)	<b>V</b>	<b>T</b>
] (right square bracket)	<b>V</b>	<b>T</b>
{ (left curly brace)	N/A	<b>U</b>
} (right curly brace)	N/A	<b>U</b>

## Appendix B – Keypads and Keystrokes

























To Enter	Large Alpha Keypad	Alphanumeric Keypad
~ (tilde)	N/A	 
\ (backslash)	 	 
/ (forward slash)	 	 
“ (quotes)	N/A	 
( (left parenthesis)	 	N/A
) (right parenthesis)	 	N/A
Insert	 	 
Delete	 	 
Sym	 	N/A
(broken vertical bar)	N/A	 
` (grave)	N/A	 
Forward Tab		
Backspace		
Up Arrow		
Down Arrow		
Left Arrow		
Right Arrow		
CapsLock	 	 
Enter		
ok	 	 
Shift		

To Enter	Large Alpha Keypad	Alphanumeric Keypad
Space		
Start (Windows)	  or  	  or  
Esc		
Alt	N/A	<b>Alt</b>
Ctrl	<b>Ctrl</b>	<b>Ctrl</b>
Send Call	 	 
End Call	 	 
Intermec Dashboard		

### CK70 Function Keys



















To Enter	Large Alpha Keypad	Alphanumeric Keypad
F1	 	
F2	 	
F3	 	
F4	 	
F5	 	
F6	 	 
F7	 	 
F8	 	 
F9	 	 
F10	 	 
F11	N/A	 
F12	N/A	 

## Appendix B – Keypads and Keystrokes

To Enter	Large Alpha Keypad	Alphanumeric Keypad
F13	N/A	 
F14	N/A	 
F15	N/A	 
F16	N/A	 
F17	N/A	 
F18	N/A	 
F19	N/A	 
F20	N/A	 
F21	N/A	 
F22	N/A	 
F23	N/A	 
F24	N/A	 

## CK71 Keypads and Keystrokes

### CK71 Alphanumeric Characters

Character	Numeric With Function Keys Keypad	Alphanumeric Keypad
a	 	
b	 	
c	 	
d	 	
e	 	
f	 	

Character	Numeric With Function Keys Keypad	Alphanumeric Keypad
g	1	G
h	2	H
i	3	I
j	0	J
k	-	K
l	F1	L
m	F2	M
n	F3	N
o	F4	O
p	F5	P
q	F6	Q
r	F7	R
s	F8	S
t	F9	T
u	F10	U
v	F11	V
w	F12	W
x	?	X
y	Ctrl	Y
z	Alt	Z
A	7	A

## Appendix B – Keypads and Keystrokes

Character	Numeric With Function Keys Keypad	Alphanumeric Keypad
B	<b>8</b>	<b>B</b>
C	<b>9</b>	<b>C</b>
D	<b>4</b>	<b>D</b>
E	<b>5</b>	<b>E</b>
F	<b>6</b>	<b>F</b>
G	<b>1</b>	<b>G</b>
H	<b>2</b>	<b>H</b>
I	<b>3</b>	<b>I</b>
J	<b>0</b>	<b>J</b>
K	<b>-</b>	<b>K</b>
L	<b>F1</b>	<b>L</b>
M	<b>F2</b>	<b>M</b>
N	<b>F3</b>	<b>N</b>
O	<b>F4</b>	<b>O</b>
P	<b>F5</b>	<b>P</b>
Q	<b>F6</b>	<b>Q</b>
R	<b>F7</b>	<b>R</b>
S	<b>F8</b>	<b>S</b>
T	<b>F9</b>	<b>T</b>
U	<b>F10</b>	<b>U</b>
V	<b>F11</b>	<b>V</b>









































Character	Numeric With Function Keys Keypad	Alphanumeric Keypad
W		
X		
Y	<b>Ctrl</b>	
Z	<b>Alt</b>	
0		
1		
2		
3		
4		
5		
6		
7		
8		
9		

**CK71 Characters and Functions**









To Enter	Numeric With Function Keys Keypad	Alphanumeric Keypad
: (colon)		
; (semicolon)	N/A	
, (comma)	N/A	
\$ (dollar)		N/A
! (exclamation)		N/A

## Appendix B – Keypads and Keystrokes







































































To Enter	Numeric With Function Keys Keypad	Alphanumeric Keypad
- (hyphen or minus)		Space
. (period)		
+ (plus)	N/A	Space
‘ (apostrophe)	N/A	
= (equals)	N/A	
_ (underscore)		
> (greater than)	N/A	
< (less than)	N/A	
[ (left square bracket)	N/A	
] (right square bracket)	N/A	
{ (left curly brace)	N/A	
} (right curly brace)	N/A	
~ (tilde)	N/A	
\ (backslash)	<b>Alt</b>	
/ (forward slash)	<b>Ctrl</b>	
“ (quotes)	N/A	
Insert		
Delete		
‡ (broken vertical bar)	N/A	
` (grave)	N/A	
Forward Tab		

To Enter	Numeric With Function Keys Keypad	Alphanumeric Keypad
Backspace		
Up Arrow		
Down Arrow		
Left Arrow		
Right Arrow		
CapsLock	 	 
Enter		
ok	 	 
Shift		
Space		
Start (Windows)	  or  	  or  
Esc		
Alt	<b>Alt</b>	 
Ctrl	<b>Ctrl</b>	<b>Ctrl</b>
Intermec Dashboard		

### CK71 Function Keys

To Enter	Numeric With Function Keys Keypad	Alphanumeric Keypad
F1		
F2		
F3		
F4		



























## Appendix B – Keypads and Keystrokes

To Enter	Numeric With Function Keys Keypad	Alphanumeric Keypad
F5		
F6		 
F7		 
F8		 
F9		 
F10		 
F11		 
F12		 
F13	 	 
F14	 	 
F15	 	 
F16	 	 
F17	 	 
F18	 	 
F19	 	 
F20	 	 
F21	 	 
F22	 	 
F23	 	 
F24	 	 

**CK71 Intermecc Terminal Emulation (ITE) Keys**

To Enter	Numeric With Function Keys Keypad	Alphanumeric Keypad
Attention	<b>0</b>	<b>A</b>
Autolog	N/A	<b>F4</b>
Clear	<b>6</b>	<b>6</b>
Duplicate	N/A	<b>D</b>
EEOF	N/A	<b>F5</b>
Erase	N/A	<b>E</b>
Find	N/A	<b>F</b>
Field +	<b>FldExit</b>	<b>1</b>
Field -	<b>FldExit</b>	<b>1</b>
Fieldmark	N/A	<b>G</b>
Help	N/A	<b>3</b>
Hex	N/A	<b>I</b>
Home	<b>.</b>	<b>H</b>
Keypad	N/A	<b>K</b>
Menu	N/A	<b>M</b>
Mode	N/A	<b>O</b>
New Line	N/A	<b>N</b>
Next Screen	<b>9</b>	<b>9</b>
PA1	<b>1</b>	<b>F1</b>
PA2	<b>2</b>	<b>F2</b>

## Appendix B – Keypads and Keystrokes

To Enter	Numeric With Function Keys Keypad	Alphanumeric Keypad
PA3	 <b>3</b>	 <b>F3</b>
Page	 	 
Print	N/A	 <b>P</b>
Previous Screen	 <b>7</b>	 <b>7</b>
Remove	N/A	 <b>R</b>
Reset	 <b>Esc</b>	 <b>Esc</b>
Return	 <b>Enter</b>	 <b>Enter</b>
Roll Down	 <b>5</b>	 <b>5</b>
Roll Up	 <b>8</b>	 <b>8</b>
System Request	 	 <b>Q</b>
View	N/A	 
View Down	 	N/A
View Up	 	N/A

# C

## ScanNGo Wi-Fi Configuration Bar Codes

You can use the ScanNGo Wi-Fi configuration bar codes to quickly configure the 802.11 radio in your computer.

## Radio Configuration Bar Codes

Use the following ScanNGo bar codes to enable the 802.11 radio and set the defaults for either Funk or Microsoft Wireless Zero Configuration security. After you scan the bar codes, you will still need to use Intermec Settings or another configuration program to set network-specific settings on your computer and to configure the wireless security.

The CN70, CN70e, and CK70 are available with the EA30 imager only. The CK71 has three imager options: the EA30, EX25, or EV12 imager. If your CK71 has an EA30 or EX25 imager, use the 2D configuration bar codes to configure the radio. If your CK71 has an EV12 imager, use the 1D configuration bar codes to configure the radio. You can find out what imager is in your CK71 by opening Intermec Settings and tapping **Data Collection > Internal Scanner > Scanner Settings**.



**Note:** If you are using Microsoft security, you can only use the 1D configuration bar codes.

The following ScanNGo bar codes were created using SmartSystems Foundation. For more information on SmartSystems Foundation, see [“Manage the Computer Using SmartSystems” on page 106](#).

## 2D Configuration Bar Codes

You can configure the computer with a 2D imager (EA30 or EX25).

- 1 Scan the appropriate bar code from the table and wait for the program to start.
- 2 Follow any instructions on the device.



## 2D Imager Radio Configuration Bar Codes

### When You Want To:

- Set all communication settings to defaults (Wi-Fi, WWAN if applicable)
- Enable Wi-Fi - set Funk defaults

### Scan This Bar Code

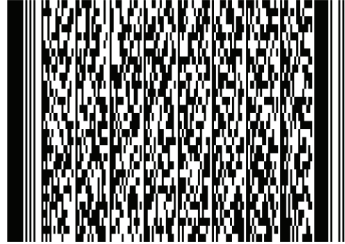

---

## 1D Configuration Bar Codes

You can configure the computer with a 1D imager (EV12).

- 1 Scan the **START HERE** bar code from the table and wait for the program to start.
- 2 Scan the **1/9** bar code.
- 3 Scan the rest of the bar codes in any order.
- 4 Follow any instructions on the device.

## Appendix C – ScanNGo Wi-Fi Configuration Bar Codes

### 1D Imager Radio Configuration Bar Codes

#### When You Want To:

#### Scan This Bar Code

- Set all communication settings to defaults (Wi-Fi, WWAN if applicable)
- Enable Wi-Fi - set Funk defaults



START HERE



1/9



2/9



3/9



4/9



5/9

**When You Want To:**

**Scan This Bar Code**

- Set all communication settings to defaults (Wi-Fi, WWAN if applicable)
- Enable Wi-Fi - set Funk defaults



6/9



7/9



8/9



9/9

---

## Appendix C – ScanNGo Wi-Fi Configuration Bar Codes

### When You Want To:

### Scan This Bar Code

- Set all communication settings to defaults (Wi-Fi, WWAN if applicable)
- Enable Wi-Fi - set Microsoft WZC defaults



START HERE



1/9



2/9



3/9



4/9



5/9



6/9

<b>When You Want To:</b>	<b>Scan This Bar Code</b>
--------------------------	---------------------------

- Set all communication settings to defaults (Wi-Fi, WWAN if applicable)
- Enable Wi-Fi - set Microsoft WZC defaults



7/9



8/9



9/9

---

***Appendix C – ScanNGo Wi-Fi Configuration Bar Codes***



# Index

**Symbols**

.cab files, using to install applications 108

**Numerics**

70 Series  
    computer models 2  
    features 5  
802.11 communications,  
    configuring 83  
802.11 network status,  
    troubleshooting 117  
802.11 radio, default settings 145  
802.1x security  
    configuring with Funk 95  
    configuring with Microsoft 100  
    troubleshooting 116

**A**

accessories, described 8  
activation wizard, starting 56  
ActiveSync  
    establishing a partnership 36  
    using to install applications 109  
aligning the screen 45  
alpha keypad, CK70, illustrated 19  
alphanumeric keypad  
    CK70, illustrated 20  
    CK71, illustrated 22  
applications  
    developing with Intermec  
        Resource Kits 108  
    installing with  
        ActiveSync 109  
        computer as mass storage  
            device 37  
        Console 109  
        storage card 110  
    Intermec, available for download  
        47  
    Intermec, available on computer  
        45  
    launching automatically 110  
    packaging 108  
    troubleshooting 123  
ASCII scanner, connecting 89  
audio device, connecting with  
    Bluetooth 88  
audio snap-on adapter, described 8  
AutoRun, described 109

AutoRun.exe, using to start  
    application 110

**B**

back accessory interface  
    described 8  
    pin-outs 130  
backlight  
    configuring screen 27  
    keypad behavior 19  
bar code  
    default symbology settings 143  
    radio configuration 178  
    reading 29  
    reading, troubleshooting 118  
    symbologies 132  
battery  
    about 10  
    battery icons, described 13  
    changing 11  
    charging 11  
    charging accessories 11  
    checking the status 13  
    conserving battery life 15  
    described 8  
    status LED 14  
Bluetooth  
    Audio application described 46  
    audio device, connecting to 88  
    communications, configuring  
        84–88  
    printer, connecting to 87  
    scanner, connecting to 85

**C**

calculator-style keypad  
    entering characters on 23  
    illustrated 18  
calling product support 122  
camera  
    configuring 65  
    described 62  
    recording video 66  
    settings, described 62  
    taking a picture 66  
Carrier Selection application  
    described 46  
Carrier Selection application, using  
    to switch network carriers 57  
carriers  
    supported 55  
    switching 57



- CDMA phone
    - activating 54
    - carriers 54
  - certificate, loading 102
  - changing the battery 11
  - characters
    - entering on CK70/CK71 keypad 24
    - entering on numeric keypad 23
    - entering on QWERTY keypad 23
    - entering with keystrokes 152–176
  - charging accessories 11
  - charging the battery 11
  - CK70
    - keypads, illustrated 19, 20
    - keystrokes, listed 161–168
    - status LEDs 6, 7
  - CK70/CK71
    - battery, described 8
    - entering characters on keypad 24
    - magstripe reader adapter, described 8
  - CK71
    - keypads, illustrated 21, 22
    - keystrokes, listed 168–176
    - status LEDs 7
  - clean boot, performing 125
  - cleaning computer 125
  - CloneNGo
    - using to manage computer 106
  - CloneNGo application
    - described 46
  - CN70
    - keypads, illustrated 16, 17
    - keystrokes, listed 152–156
    - status LEDs 6
  - CN70/CN70e
    - battery, described 8
    - vehicle dock, described 9
    - vehicle holder, described 9
  - CN70e
    - keypads, illustrated 17, 18
    - keystrokes, listed 157–161
  - cold boot, performing 123
  - communications
    - 802.11, configuring 83
    - Bluetooth, configuring 84–88
    - default settings 145
    - Ethernet, configuring 83
    - serial 88
    - USB 88
  - configuration number, finding 122
  - configuring parameters 74
  - conserving battery life 15
  - console, SmartSystems, using to install applications 109
  - contact information, Intermec ii
- D**
- Dashboard
    - about the button 26
    - button, using 114
    - described 114
    - illustration 114
    - launching 26
  - default settings
    - bar code symbologies 143
    - communications 145
    - imager 144
    - restoring Intermec Settings 81
    - scanner 144
  - desktop stand, described 8
  - DEX/UCS snap-on adapter, described 8
  - DX1 desktop dock, described 8
  - DX2 dual dock, described 9
  - DX4 quad dock, described 9
- E**
- EA30 area imager, reading distances 135
  - electrical specifications 129
  - eMDI, described 47
  - emergency phone call, making with computer 60
  - Enhanced Mobile Document Imaging (eMDI) application, described 47
  - environmental specifications 128
  - Ethernet
    - communications, configuring 83
    - snap-on adapter, described 9
  - EV12 linear imager, reading distances 137
  - EX25 imager, reading distances 139
- F**
- Features Demo, described 48
  - features of 70 Series 5

- files, transferring to and from PC 36
- fix interval, configuring with iGPS 72
- flash file store, using computer as 37
- flashlight, using 28
- flick, screen gesture, described 41
- Funk security
  - configuring 802.1x 95
  - configuring LEAP 96
  - configuring static WEP 96
  - configuring WPA Enterprise (802.1x) 93
  - configuring WPA Personal (PSK) 94
  - configuring WPA2 Enterprise (802.1x) 93
  - configuring WPA2 Personal (PSK) 94
  - profile, choosing 93
  - using open (no security) associations 97
- G**
- gestures, supported 41
- Good Read LED
  - described 7
  - troubleshooting 119
- GPS
  - configuring 70
  - GPSID, overview 70
  - improving performance 72
  - modes, described 72
- gpsOneXTRA, described 71
- H**
- handstrap replacement kit, described 9
- hard reset, performing 123
- health, monitoring computer 114
- Hibernate (battery swap), described 25
- holster, described 9
- Home screen, described 40
- horizontal scroll bar
  - described 40
  - illustration 40
- I**
- IDL (Intermec Developer Library) 108
- iGPS
  - application described 46
  - using to improve performance 72
- Image Capture, described 48
- imager
  - default settings 144
  - described 28
  - reading distances 133–142
- Intermec Browser, described 48
- Intermec Connection Manager, described 48
- Intermec Dashboard, about 114
- Intermec Developer Library (IDL) 108
- Intermec Launcher, described 49
- Intermec Resource Kits
  - described 108
  - downloading 108
- Intermec Settings
  - command reference manual link 80, 82
  - described 46, 74
  - described 74
  - hiding menu items 81
  - main menu illustration 75
  - menu options 75–80
  - navigating in 80
  - restoring default settings 81
  - restoring menu items 81
  - starting 75
  - understanding structure 75
  - using remotely with SmartSystems 82
  - using to configure Profile Settings 80
- Intermec Terminal Emulator (ITE), described 49
- Intermec, contact information ii
- Internet Service Provider (ISP)
  - connection, creating 89
- ISpyWiFi
  - application described 46
  - diagnosing Wi-Fi status 117
- K**
- Key status LED, described 8
- keypad
  - backlight behavior 16, 19
  - illustrated 16

- keypad (*continued*)
  - keystrokes for entering characters 152–176
  - troubleshooting keys 121
- Knowledge Central website 122
- L**
- language provisioning 10
- launching applications
  - automatically 110
- LEAP, configuring with Funk 96
- LEDs
  - battery status, described 14
  - status, described 7
- location, status LEDs 7
- locked computer, troubleshooting 121
- M**
- magstripe reader adapter, described 8
- magstripe reader snap-on adapter, described 8
- mass storage device, using
  - computer as 37
- memory, computer 130
- microSD card
  - about 30
  - installing in a CK70/CK71 33
  - installing in a CN70/CN70e 30
  - updating system software 112
  - using to save pictures and videos 67
- Microsoft security
  - choosing 97
  - configuring 802.1x 100
  - configuring static WEP 101
  - configuring WPA Enterprise (802.1x) 98
  - configuring WPA Personal (PSK) 99
  - configuring WPA2 Enterprise (802.1x) 98
  - configuring WPA2 Personal (PSK) 99
  - using open (no security) associations 102
- Mobile Equipment Identifier (MEID), locating 55
- models of 70 Series computers 2
- MS Assisted mode, described 71
- N**
- network
  - carriers, switching 57
  - connection, troubleshooting 115
  - non-incendive (NI) specifications 129
- Notification LED, described 7
- numeric keypad
  - CK71, illustrated 21
  - CN70, illustrated 17
  - CN70e, illustrated 18
  - entering characters on 23
  - illustrated 16
- O**
- open associations
  - configuring with Funk 97
  - configuring with Microsoft WZC 102
- operating system
  - finding version 123
  - version 2
- P**
- pan, screen gesture, described 41
- phone
  - CDMA, activating 54
  - features 52
  - making a call 60
  - making an emergency call 60
  - turning on and off 56
  - UMTS, activating 52
- physical specifications 128
- picture
  - saving to a microSD card 67
  - storage location 66
  - taking with camera 66
- pin-outs, back accessory interface 130
- Power button, described 25
- power options
  - customizing 26
  - setting 25
- power specifications 129
- predefined imager mode, choosing 29
- printer, connecting with Bluetooth 87
- processor, computer 130

- product support
  - calling 122
- Profile Settings
  - application, described 46
  - configuring with Intermec Settings 80
- profile, choosing Funk security 93
- Q**
- QWERTY keypad
  - CN70, illustrated 16
  - entering characters on 23
  - illustrated 16
- QWERTY numeric keypad
  - CN70e, illustrated 17
- R**
- reading distances
  - EA30 area imager 135
  - EV12 linear imager 137
  - EX25 imager 139
- Ready-to-Work LED
  - described 7
- reboot
  - performing 123
  - power option described 26
- recording a video 66
- regulatory approvals 131
- reset
  - button, location 124
  - performing 123
- RS-232 snap-on adapter, described 9
- S**
- scan handle, described 9
- ScanDiagnostic
  - Intermec application described 47
  - using to troubleshoot 120
- scanner
  - Bluetooth, connecting to 85
  - default settings 144
  - supported tethered and cordless 29
  - tethered scanner, connecting 89
  - troubleshooting 118
- ScanNGo, radio configuration bar codes 178
- SceneEditor
  - application, described 47
  - configuring camera scenes 65
- scenes, camera setting
  - configuring 65
  - described 63
- screen
  - aligning 45
  - backlight, configuring 27
  - brightness, configuring 27
  - gestures 41
  - no response, troubleshooting 121
  - specifications 130
- Screen Off, power option, described 26
- security, wireless 92–103
- Sensor Calibration application, using to troubleshoot 121
- serial communications, about 88
- settings, default, listed 142–150
- Shift status LED, described 8
- Shutdown, power option, described 26
- SIM card, installing 52
- SmartSystems
  - console, illustration 107
  - described 49
  - downloading 107
  - ScanNGo, described 107
  - using the console to install applications 109
  - using to manage computer 106
- SmartSystems Foundation
  - Console, using to install applications 109
  - downloading 49
  - monitoring computer health 114
  - updating system software 111
  - using with remote Intermec Settings 82
- specifications
  - non-incendive (NI) 129
  - physical and environmental 128
- status icons, Title bar 42
- status LEDs
  - CK70 6
  - CN70 6
  - descriptions 7
- storage card, using to install applications 110
- storage, computer 130

Suspend, power option described 26  
 symbologies, supported 132  
 system software  
   updating with microSD card 112  
   updating with SmartSystems Foundation 111

**T**

terminal emulation,  
   troubleshooting 115  
 tethered scanner, connecting 89  
 tethered stylus replacement kit,  
   described 9  
 Tile bar  
   described 40  
   illustration 40  
 Title bar  
   described 40  
   illustration 40  
   status icon descriptions 42  
 transferring files, to and from PC 36  
 troubleshooting 115–119  
   802.11 network status 117  
   802.1x security 116  
   operation 120  
   reading bar codes 118  
   Wi-Fi connection 115  
 turning on or off phone 56, 60

**U**

UMTS phone, activating 52  
 USB communications, about 88  
 USB snap-on adapter, described 9

**V**

vehicle dock accessories, described 9  
 vehicle power adapter, described 9  
 video  
   recording 66  
   saving to a microSD card 67  
 Virtual Private Network (VPN)  
   connection, creating 91  
 Vocollect snap-on adapter,  
   described 9  
 volume, adjusting 27

**W**

Wavelink Avalanche, downloading  
   the enabler 108  
 WEP  
   static, configuring with Funk 96  
   static, configuring with  
     Microsoft 101  
 WiFi communications, supported 5  
 Wi-Fi radio, enabling 83  
 Wi-Fi, troubleshooting 115  
 Windows Embedded Handheld,  
   user interface 40  
 wireless  
   connectivity, troubleshooting 115  
 Wireless Center application,  
   described 47  
 Wireless Printing application,  
   described 47  
 Wireless Scanning application,  
   described 47  
 wireless security 92–103  
   certificate, loading 102  
   choosing Funk or WZC 92  
   configuration bar codes 178  
 Wireless Zero Configuration  
   (WZC), selecting security  
   choice 97  
 WPA  
   Enterprise (802.1x) security,  
     configuring with Funk 93  
   Enterprise (802.1x) security,  
     configuring with  
       Microsoft 98  
   Personal (PSK) security,  
     configuring with Funk 94  
   Personal (PSK) security,  
     configuring with  
       Microsoft 99  
 WPA2  
   Enterprise (802.1x) security,  
     configuring with Funk 93  
   Enterprise (802.1x) security,  
     configuring with  
       Microsoft 98  
   Personal (PSK) security,  
     configuring with Funk 94  
   Personal (PSK) security,  
     configuring with  
       Microsoft 99

## ***Index***

www.intermec.com  
Knowledge Central [122](#)  
manuals, downloading [xi](#), [xii](#)

Product Support [122](#)  
warranty information [xi](#)





Worldwide Headquarters  
6001 36th Avenue West  
Everett, Washington 98203  
U.S.A.

tel 425.348.2600

fax 425.355.9551

[www.intermec.com](http://www.intermec.com)

© 2012 Intermec Technologies  
Corporation. All rights reserved.

70 Series Mobile Computer User Manual



P/N 935-038-005