

The Intermec logo, featuring the word "Intermec" in a bold, blue, sans-serif font with a stylized blue and white graphic element to the left.

User's Manual



Intermec
CN2 Handheld
Computer

Intermec Technologies Corporation

Corporate Headquarters
6001 36th Ave. W.
Everett, WA 98203
U.S.A.

www.intermec.com

The information contained herein is proprietary and is provided solely for the purpose of allowing customers to operate and service Intermec-manufactured equipment and is not to be released, reproduced, or used for any other purpose without written permission of Intermec.

Information and specifications contained in this document are subject to change without prior notice and do not represent a commitment on the part of Intermec Technologies Corporation.

© 2005 by Intermec Technologies Corporation. All rights reserved.

The word Intermec, the Intermec logo, Norand, ArciTech, CrossBar, Data Collection Browser, dcBrowser, Duratherm, EasyADC, EasyCoder, EasyLAN, Enterprise Wireless LAN, EZBuilder, Fingerprint, i-gistics, INCA (under license), InterDriver, Intermec Printer Network Manager, IRL, JANUS, LabelShop, Mobile Framework, MobileLAN, Nor*Ware, Pen*Key, Precision Print, PrintSet, RoutePower, SmartSystems, TE 2000, Trakker Antares, and Virtual Wedge are either trademarks or registered trademarks of Intermec Technologies Corporation.

Throughout this manual, trademarked names may be used. Rather than put a trademark (™ or ®) symbol in every occurrence of a trademarked name, we state that we are using the names only in an editorial fashion, and to the benefit of the trademark owner, with no intention of infringement.

Contents

Before You Begin	vii
Safety Summary	vii
Safety Icons	viii
Global Services and Support	viii
Who Should Read This Document?	x
Related Documents	x
Patent Information	x
Other Copyright Information	xi

1 Using the CN2 Handheld Computer 1

Introducing the CN2 Handheld Computer	2
CN2 Features, Applications, and Accessories	3
Identifying the Optional Features Installed in Your CN2	3
Using the Battery	5
Installing and Charging the Battery	6
Removing the Battery	8
Maximizing Battery Life	9
Checking the Battery Status	9
Using the Keypad	10
Using the Numeric Keypad	10
Using the Scroll Keypad	12
Using the Power Key	13
Using the Touch Screen	14
Using the Touch Screen and Stylus	14
Understanding the Desktop	15
Using ScanDemo	15
Using Transcriber	16
Calibrating the Screen	17
Understanding the Screen Icons	18
Understanding the Status Lights	19
Understanding the Beeps	20
Scanning Bar Codes	21

Contents

Using the Optional SD Card.....	22
Using the Optional USB Keyboard.....	25
2 Configuring the CN2.....	29
How to Configure the CN2 Parameters.....	30
Configuring the CN2 With the Setup Assistant.....	31
Configuring the CN2 Locally With Intermec Settings.....	32
Opening Intermec Settings.....	32
Navigating Through Intermec Settings.....	33
Saving Your Settings.....	34
Exiting Intermec Settings.....	35
Restoring the CN2 Default Settings.....	35
Configuring the CN2 Remotely With Intermec Settings.....	36
3 Adding the CN2 to the Network.....	37
Configuring the CN2 For Your Network.....	38
Configuring USB Communications.....	38
Configuring 802.11b/g Radio Communications.....	39
Configuring the Network Parameters for a TCP/IP Network.....	40
Configuring the Network Parameters for a UDP Plus Network... ..	42
Configuring the CN2 for Microsoft Wireless Zero Configuration.....	43
Configuring Network Security.....	45
Choosing Between Microsoft Security and Funk Security Software.....	45
Selecting Funk as Your Security Choice.....	46
Selecting a Profile for Funk Security.....	47
Switching from Funk Security to Microsoft Security.....	48
Using WPA Security.....	48
Configuring WPA Security With Funk Security.....	49
Configuring WPA Security With Microsoft Security.....	51
Using 802.1x Security.....	53
Configuring 802.1x Security With Funk Security.....	54
Configuring 802.1x Security With Microsoft Security.....	55
Using LEAP Security.....	56
Using Static WEP Security.....	57
Configuring Static WEP Security With Funk Security.....	58

Contents

Configuring Static WEP Security With Microsoft Security	58
Loading Certificates.....	59
Disabling Security	62
Using the Modem Dock for Internet Access and E-mail.....	62
Connecting to the Internet Through the Modem Dock.....	62
Setting Up an E-mail Account Through the Modem Dock.....	69
4 Developing and Installing Applications	73
Developing Applications for the CN2.....	74
Developing a New Application	74
Developing a Web-Based Application	75
Installing Applications on the CN2.....	75
Installing Applications Using ActiveSync.....	76
Installing ActiveSync and Establishing a Partnership	77
Using ActiveSync to Copy Files and Install Applications	78
Installing Applications Using the Optional SD Card	80
Installing Applications Using Wavelink Avalanche.....	80
Launching Your Application Automatically	81
5 Troubleshooting and Maintaining the CN2	83
Problems and Solutions	84
Running Diagnostics	92
Sending the CN2 to Intermec for Service.....	94
Booting the CN2.....	94
Warm Booting the CN2.....	94
Cold Booting the CN2.....	95
Upgrading the CN2.....	96
Upgrading the Operating System.....	97
Upgrading the Persistent Storage Manager Files.....	99
Cleaning the Scanner Window and the Touch Screen.....	100

Contents

A	Specifications and Accessories	103
	Physical and Environmental Specifications.....	104
	Accessories for the CN2.....	105
B	Default Configuration	107
	Default Configuration	108
I	Index	111

Before You Begin

This section provides you with safety information, technical support information, and sources for additional product information.

Safety Summary

Your safety is extremely important. Read and follow all warnings and cautions in this document before handling and operating Intermec equipment. You can be seriously injured, and equipment and data can be damaged if you do not follow the safety warnings and cautions.

Do Not Repair or Adjust Alone

Do not repair or adjust energized equipment alone under any circumstances. Someone capable of providing first aid must always be present for your safety.

First Aid

Always obtain first aid or medical attention immediately after an injury. Never neglect an injury, no matter how slight it seems.

Resuscitation

Begin resuscitation immediately if someone is injured and stops breathing. Any delay could result in death. To work on or near high voltage, you should be familiar with approved industrial first aid methods.

Energized Equipment

Never work on energized equipment unless authorized by a responsible authority. Energized electrical equipment is dangerous. Electrical shock from energized equipment can cause death. If you must perform authorized emergency work on energized equipment, be sure that you comply strictly with approved safety regulations.

Before You Begin

Safety Icons

This section explains how to identify and understand warnings, cautions, and notes that are in this document.



A warning alerts you of an operating procedure, practice, condition, or statement that must be strictly observed to avoid death or serious injury to the persons working on the equipment.

Avertissement: Un avertissement vous avertit d'une procédure de fonctionnement, d'une méthode, d'un état ou d'un rapport qui doit être strictement respecté pour éviter l'occurrence de mort ou de blessures graves aux personnes manipulant l'équipement.



A caution alerts you to an operating procedure, practice, condition, or statement that must be strictly observed to prevent equipment damage or destruction, or corruption or loss of data.

Attention: Une précaution vous avertit d'une procédure de fonctionnement, d'une méthode, d'un état ou d'un rapport qui doit être strictement respecté pour empêcher l'endommagement ou la destruction de l'équipement, ou l'altération ou la perte de données.



Note: Notes either provide extra information about a topic or contain special instructions for handling a particular condition or set of circumstances.

Global Services and Support

Warranty Information

To understand the warranty for your Intermec product, visit the Intermec web site at www.intermec.com and click **Service & Support > Service & Support**. The **Intermec Global Sales & Service** page appears. From the **Service & Support** menu, move your pointer over **Support**, and then click **Warranty**.

Disclaimer of warranties: The sample code included in this document is presented for reference only. The code does not

Before You Begin

necessarily represent complete, tested programs. The code is provided “as is with all faults.” All warranties are expressly disclaimed, including the implied warranties of merchantability and fitness for a particular purpose.

Web Support

Visit the Intermec web site at www.intermec.com to download our current manuals in PDF format. To order printed versions of the Intermec manuals, contact your local Intermec representative or distributor.

Visit the Intermec technical knowledge base (Knowledge Central) at intermec.custhelp.com to review technical information or to request technical support for your Intermec product.

Telephone Support

These services are available from Intermec Technologies Corporation.

Service	Description	In the U.S.A. and Canada call 1-800-755-5505 and choose this option
Factory Repair and On-site Repair	Request a return authorization number for authorized service center repair, or request an on-site repair technician.	1
Technical Support	Get technical support on your Intermec product.	2
Service Contract Status	Inquire about an existing contract, renew a contract, or ask invoicing questions.	3
Schedule Site Surveys or Installations	Schedule a site survey, or request a product or system installation.	4
Ordering Products	Talk to sales administration, place an order, or check the status of your order.	5

Outside the U.S.A. and Canada, contact your local Intermec representative. To search for your local representative, from the Intermec web site, click **Contact**.

Before You Begin

Who Should Read This Document?

The *CN2 Handheld Computer User's Manual* provides you with information about the features of the CN2 and how to install, operate, maintain, and troubleshoot the CN2.

Before you install and configure the CN2, you should be familiar with your network and general networking terms, such as IP address.

Related Documents

The Intermec web site at www.intermec.com contains our documents that you can download as PDF files.

To order printed versions of the Intermec manuals, contact your local Intermec representative or distributor.

The *Intermec Computer Command Reference Manual* (P/N 073529) is available as a download from the Intermec web site. Please refer to this manual for help configuring your CN2. The reference manual contains information about most of the CN2 commands.

Patent Information

Product is covered by one or more of the following patents:
4,455,523; 4,553,081; 4,709,202; 4,845,419; 4,961,043;
5,195,183; 5,216,233; 5,218,187; 5,218,188; 5,227,614;
5,241,488; 5,278,487; 5,322,991; 5,331,136; 5,331,580;
5,349,678; 5,397,885; 5,371,858; 5,373,478; 5,410,141;
5,488,575; 5,500,516; 5,504,367; 5,508,599; 5,530,619;
5,567,925; 5,568,645; 5,592,512; 5,598,007; 5,617,343;
5,627,360; 5,657,317; 5,671,436; 5,684,290; 5,777,309;
5,793,604; 5,805,807; 5,818,027; 5,821,523; 5,828,052;
5,831,819; 5,834,753; 5,841,121; 5,844,222; 5,883,492;
5,883,493; 5,886,338; 5,889,386; 5,898,162; 5,969,328;
5,986,435; 6,075,340; 6,109,528; 6,158,661; 6,234,395;
6,244,512; 6,330,975; 6,431,451; 6,497,368; 6,538,413;
Des. 417,445.

There may be other U.S. and foreign patents pending.

Other Copyright Information

Microsoft, Windows, and the Windows logo are registered trademarks of Microsoft Corporation in the United States and/or other countries.

Wi-Fi is a registered certification mark of the Wi-Fi Alliance.

This product includes software developed by the OpenSSL Project for use in the OpenSSL Toolkit. (www.openssl.org/)

This product includes cryptographic software written by Eric Young. (ey@cryptsoft.com)

This product uses Regex++, Index software during its operational phases. The owner of Regex++ has granted use of the software to anyone provided such use is accompanied by the following copyright and permission notice:

Regex++, Index. (Version 3.31, 16th Dec 2001)

Copyright © 1998-2001 Dr John Maddock

Permission to use, copy, modify, distribute and sell this software and its documentation for any purpose is hereby granted without fee, provided that the above copyright notice appear in all copies and that both that copyright notice and this permission notice appear in supporting documentation. Dr John Maddock makes no representations about the suitability of this software for any purpose. It is provided “as is” without express or implied warranty.

Before You Begin



1 Using the CN2 Handheld Computer

Use this chapter to familiarize yourself with the CN2 handheld computer. In this chapter you will find these sections:

- Introducing the CN2 Handheld Computer
- Using the Battery
- Using the Keypad
- Using the Touch Screen
- Understanding the Screen Icons
- Understanding the Status Lights
- Understanding the Beeps
- Scanning Bar Codes
- Using the Optional SD Card
- Using the Optional USB Keyboard

Introducing the CN2 Handheld Computer

The Intermec CN2 handheld computer is an ergonomically-designed handheld computer built on the Microsoft® Windows® CE .NET operating system. It is a semi-rugged, lightweight computer that runs client/server applications and browser-based applications.

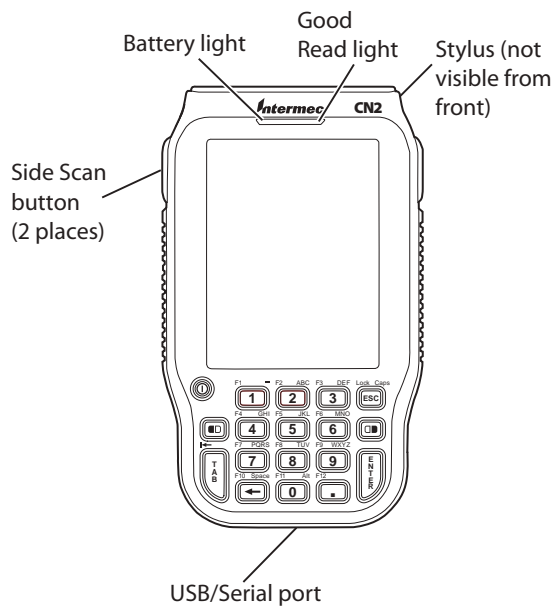

CN2 Handheld Computer With Numeric Keypad



The CN2 handheld computer with an IEEE 802.11b/g radio installed is Wi-Fi® certified for interoperability with other 802.11b/g wireless LAN devices.

CN2 Features, Applications, and Accessories

The CN2 includes these features:

- 802.11b/g radio (optional)
- .NET Compact Framework
- CCX v1.0 certification
- IPv6 support
- Quarter VGA color display with touch screen
- 18-key numeric keypad or 10-key scroll keypad
- 1D linear imager (optional)
- 64MB flash/128MB RAM memory
- 400 MHz Intel® XScale™ processor

The CN2 ships with these installed applications:

- CE Internet Explorer 6
- CE Media Player
- Inbox
- ScanDemo
- Transcriber
- Wavelink Avalanche Enabler
- WordPad

For a complete list of accessories, see “Accessories for the CN2” on page 105.

Identifying the Optional Features Installed in Your CN2

Before you continue learning to use your CN2, you need to determine which optional features are installed in your CN2:

- 802.11b/g radio
- Numeric or scroll keypad
- 1D linear imager

Chapter 1 — Using the CN2 Handheld Computer

Does Your CN2 Contain an 802.11b/g Radio?

How to Determine	Description	In this Manual
Look at the Configuration Number (CN) on the label inside the battery compartment. For help removing the battery door and the battery, see page 8. If the CN ends in 8xx, your CN2 contains a radio. For example, CN2A21E10N2804.	You have a wireless CN2, which can communicate in a wireless network.	For details about wireless communications, see “Configuring 802.11b/g Radio Communications” on page 39.
If the CN ends in 000, your CN2 does not contain a radio. For example, CN2A11E10N2000.	You have a batch CN2, which requires a modem dock or communications dock to communicate with a network.	For details about batch communications, see “Configuring USB Communications” on page 38.

Does Your CN2 Contain a Numeric or Scroll Keypad?

How to Determine	Description	In this Manual
The numeric keypad has 18 keys.	You can type numbers and letters, and you can access function keys (such as F1).	For details, see “Using the Numeric Keypad” on page 10.
The scroll keypad has 10 keys.	You can use the arrow keys to move through applications, and you can access function keys (such as F1).	For details, see “Using the Scroll Keypad” on page 12.

Does Your CN2 Scan Bar Codes?

How to Determine	Description	In this Manual
The top of the CN2 contains a clear scanner window.	You can scan bar codes with your CN2.	For details, see “Scanning Bar Codes” on page 21.
The top of the CN2 does not contain a clear scanner window.	You cannot scan bar codes with your CN2.	Ignore all references to scanning bar codes in this manual.

Using the Battery

The CN2 uses a lithium-ion battery as its main power source. You must fully charge the main battery before you can use the CN2. When you change the battery, the backup battery maintains the computer's status, memory, and real-time clock for at least 5 minutes.



The lithium-ion battery pack that is used in this device may present a fire or chemical burn hazard if it is mistreated. Do not disassemble it, heat it above 100°C (212°F), or incinerate it.

Avertissement: Le paquet de piles d'ions de lithium qui est utilisé dans cet appareil peut présenter un risque de feu ou un risque chimique de brûlure s'il est maltraité. Il ne faut pas le désassembler, le réchauffer à une température plus élevée que 100°C (212°F) ou l'incinérer.



Removing the main battery when the backup battery low or critically low icon appears on the status bar may cause your CN2 to cold boot and you may lose data.

Attention: Si vous enlevez la batterie principale quand l'icône de batterie de secours dans la barre de statut indique bas ou bas critique, cela peut causer une botte froide à votre CN2 et vous risquez de perdre des données.



If you fail to replace the battery immediately, you may lose important data or applications.

Attention: Si la batterie n'est pas remplacée immédiatement, des données ou applications importantes risquent d'être perdues.

Dispose of used battery packs promptly. Keep away from children. Contact your local Intermec sales representative for replacement batteries.

Several factors determine the life of your battery, such as extreme temperatures and your usage.

Installing and Charging the Battery

Make sure you fully charge the battery before you use your CN2. To charge the battery, you need to install it in the CN2.

To install and charge the battery

- 1 Push down on the battery door latch, and pull up on the battery door.

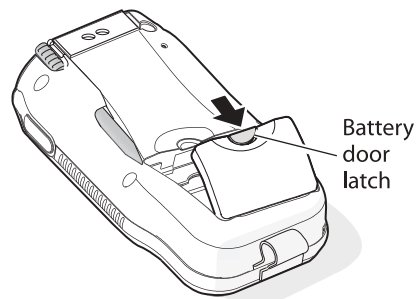

- 2 Remove the battery door and set it aside.
- 3 Align the battery contacts, and insert the battery in the battery compartment. Press down on the battery until it clicks into place.

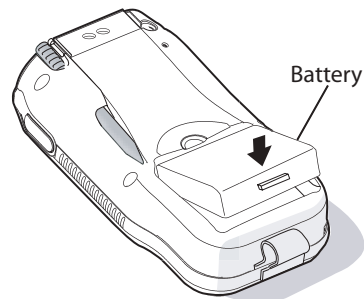

- 4 Replace the battery door.
- 5 Connect the AC power supply (P/N 074246) to the power connector on the back of the CN2 communications dock (P/N 225-696-001), and then connect the power cord to the AC power supply.



You must use only the Intermec power supply approved for use with the CN2. Using any other power supply will damage the CN2.

Attention: Vous devez utiliser seulement le bloc d'alimentation Intermec désigné pour le CN2. L'utilisation d'autres blocs d'alimentation endommagera le CN2.



Note: For help installing and using the communications dock, see the *CN2 Communications Dock Quick Start Guide* (P/N 930-061-001), which shipped with the dock.

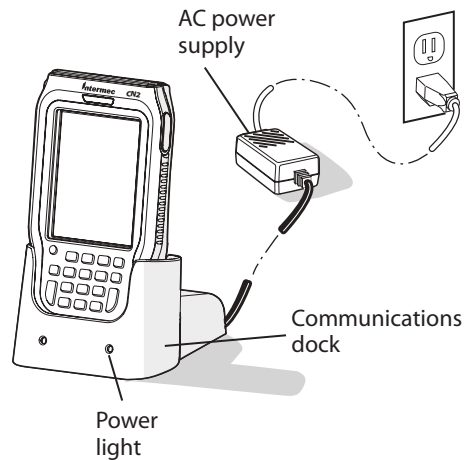

- 6 Connect the power cord to an AC power outlet. The green Power light on the communications dock turns on.
- 7 Place the CN2 in the communications dock. The battery is fully charged in approximately 4 hours.

Removing the Battery

Follow these instructions to remove the battery from the CN2.



Only use the stylus to remove the battery. If you use any other tool or method to remove the battery, you may damage the battery or the CN2.

Attention: Utilisez uniquement le stylet pour retirer la pile. Si vous utilisez un autre instrument ou une autre méthode pour le faire, vous risquez d'endommager la pile ou le CN2.



Removing the main battery when the backup battery low or critically low icon appears on the status bar may cause your CN2 to cold boot and you may lose data.

Attention: Si vous enlevez la batterie principale quand l'icône de batterie de secours dans la barre de statut indique bas ou bas critique, cela peut causer une botte froide à votre CN2 et vous risquez de perdre des données.



If you fail to replace the battery immediately, you may lose important data or applications.

Attention: Si la batterie n'est pas remplacée immédiatement, des données ou applications importantes risquent d'être perdues.

To remove the battery

- 1 Push down on the battery door latch, and pull up on the battery door.

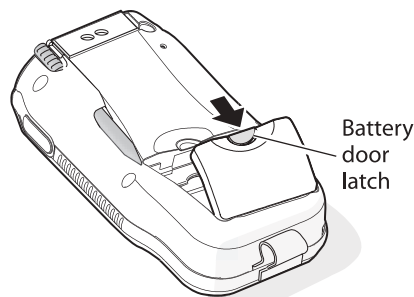

Chapter 1 — Using the CN2 Handheld Computer

- 2 Remove the battery door and set it aside.
- 3 Insert the stylus between the battery and the CN2 case, and press straight down until the battery is released.

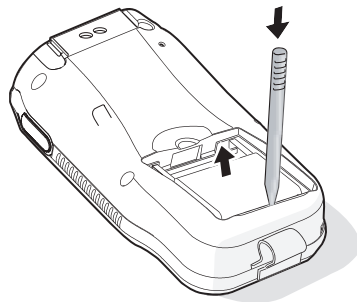

- 4 Lift the battery out of the battery compartment.

Maximizing Battery Life

There are several things that you can do to maximize the life of your fully charged battery.



- Set the Backlight Timeout to 10 seconds.
- Verify that Radio Power Management is enabled (Fast PSP). Enabling radio power management allows your radio to switch between awake and sleep modes based on network traffic.
- Verify that each setting under Power Management has a value of 1 minute for a combined automatic shutoff time of 3 minutes.

You can use Intermec Settings to easily make all of these configuration changes. For help, see “Configuring the CN2 Locally With Intermec Settings” on page 32.

Checking the Battery Status

The easiest way to tell the status of your battery is to look at the battery icon on the taskbar of your CN2. For help locating the taskbar, see the illustration on page 14.

Battery Icon Status

Icon	Status
	The battery is charging.
	The battery is low. You need to charge the battery soon.
	The battery is critically low. You need to charge the battery now.

Using the Keypad

The CN2 has either an 18-key numeric keypad or a 10-key scroll keypad.

Using the Numeric Keypad

You enter all of the characters and functions printed on the keys just like you would on a standard keyboard.

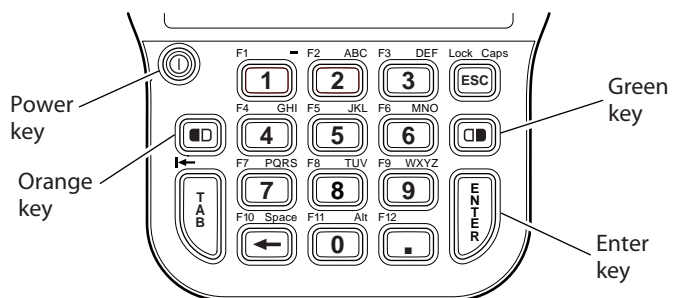

CN2 18-Key Numeric Keypad

The **Orange** (■□) and **Green** (□■) keys let you access the additional functions printed on the keypad overlay.

To access functions printed in orange on the keypad overlay







- 1 Press and release the **Orange** (■□) key. The ■□ icon appears in the taskbar and Orange mode is enabled.

The ■□ icon remains on until you press another key or press the **Orange** key again.







Chapter 1 — Using the CN2 Handheld Computer

- 2 Press and release the key below the function printed in orange. For example, press the **5** key to access the F5 function, which refreshes the selected folder or desktop. The  icon turns off.



To access characters printed in green on the keypad overlay

- 1 Press and release the **Green** () key. The  icon appears in the taskbar and Green mode is locked.
The  icon remains on until you press  again.
- 2 Press and release the key below the character printed in green. For example, press the **2** key twice to type a lowercase **b** character.
- 3 Press and release  to disable Green mode. The  icon turns off.

To type uppercase characters

- 1 Press and release the **Green** () key. The  icon appears in the taskbar and Green mode is locked.
- 2 Press and release the **ESC** key. The **Caps Lock** () icon appears in the taskbar.
- 3 Type a few uppercase characters. For example, to type BYE, follow these steps:
 - a Press the **2** key twice to type B.
 - b Press the **9** key three times to type Y.
 - c Press the **3** key twice to type E.
- 4 Press and release the **ESC** key. The  icon turns off.
- 5 Press and release  to disable Green mode. The  icon turns off.

To delete characters

- 1 Make sure neither  nor  appear in the taskbar.
- 2 Press the **Backspace** () key.

Using the Scroll Keypad

You enter all of the characters and functions printed on the keys just like you would on a standard keyboard.

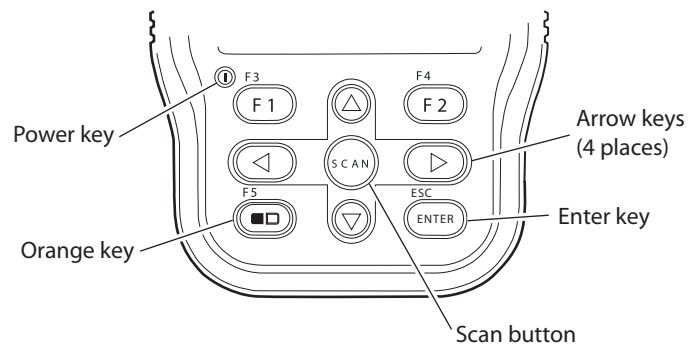

CN2 10-Key Scroll Keypad

The **Orange** (■□) key lets you access the additional functions printed on the keypad overlay.

To access functions printed on the keypad overlay

- 1 Press and release the **Orange** (■□) key. The ■□ icon appears in the taskbar and Orange mode is enabled.
- 2 Press and release the key below the function printed on the keypad overlay. For example, press the **Orange** key again to access the F5 function, which refreshes the selected folder or desktop. The ■□ icon turns off.

If you do not press another key within 3 seconds of pressing the **Orange** key, the ■□ icon turns off and Orange mode is disabled.

Using the Power Key

The **Power** key is the round yellow key in the upper left corner of both keypads.

Actions You Can Perform With the Power Key

Action	Do This	Description
To turn on the CN2	Press and release the Power key.	Your CN2 resumes where it was when you turned it off. If you are using WPA or 802.1x security, the computer may need to reauthenticate before it starts your application.
To turn off the CN2	Press the Power key for 2 to 3 seconds and then release it.	Your CN2 enters Suspend mode. In Suspend mode, the CN2 continues to supply power to all memory, but turns off power to most hardware. This power-saving feature is designed to prolong battery life.
To toggle the backlight	Press the Power key for 5 to 6 seconds and then release it.	The CN2 backlight toggles (turns on or off) but the CN2 continues running.
To warm boot the CN2	Press the Power key for 10 seconds and then release it.	For details, see “Warm Booting the CN2” on page 94.



Note: If your CN2 does not resume after you press the **Power** key, your battery may be too low to supply power. Replace or charge the battery. If replacing or charging the battery does not solve the problem, see “Booting the CN2” on page 94.

Using the Touch Screen

The CN2 has a color touch-screen display. The screen is 240 x 320 pixels. The desktop is 240 x 300 pixels and the taskbar is 240 x 20 pixels. In addition, the screen supports Unicode characters, user-programmable fonts, and bitmap graphics.

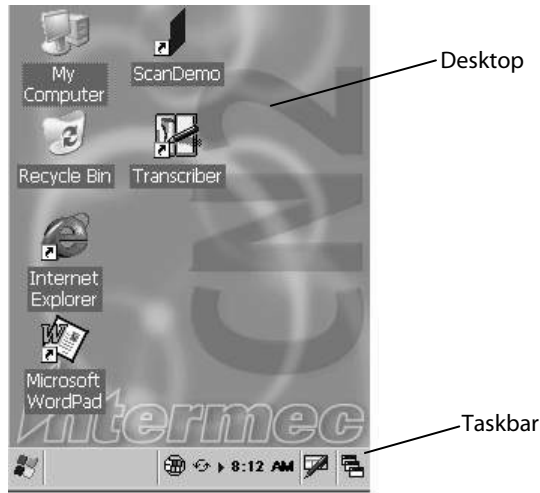

CN2 Start Screen

Using the Touch Screen and Stylus

Your CN2 has a stylus for selecting items and entering information. Use the stylus in place of a mouse.

Functions You Can Perform With the Stylus

Action	Description
Tap	Touch the screen once with the stylus to open items and select options.
Drag	Hold the stylus on the screen and drag across the screen to select text and images.
Tap and hold	Tap and hold the stylus on an item to see a list of actions available for that item. On the pop-up menu that appears, tap the action you want to perform.

Understanding the Desktop

The Start screen has two distinct areas: the desktop and the taskbar. The desktop displays shortcuts to some of the applications installed on the CN2. The first time you turn on the CN2, the taskbar displays the Start menu icon, the time, the keyboard icon, and the desktop icon.

Most of the default shortcuts on the desktop are standard Windows CE applications. However, Intermec provides shortcuts to two additional applications:

- ScanDemo is a simple application you can use to verify that your imager is working correctly.
- Transcriber enables you to write on the screen with your stylus, and then it converts your writing to text.

Using ScanDemo

ScanDemo is an application that enables the CN2 to read bar code labels and display the information encoded on the label along with the symbology used to encode it.

To open ScanDemo

- 1 Double-tap the **ScanDemo** shortcut on the desktop. The ScanDemo application opens.
- 2 Scan a bar code label. For information on how to scan a bar code label, see “Scanning Bar Codes” on page 21. The information you scanned along with the symbology used to encode it appears on the screen.

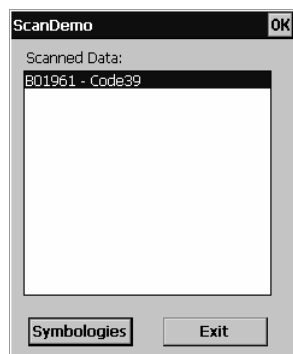

To enable or disable symbologies

- 1 From the ScanDemo window, tap the **Symbologies** button to see the symbologies that are enabled.

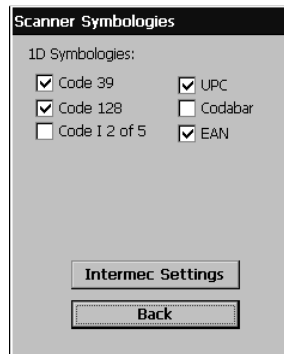

- 2 Select or clear the symbologies you want to use and tap **Back**.
- 3 If you want to configure symbology parameters, tap **Intermec Settings**. Intermec Settings appears on your screen.
- 4 From the Intermec Settings application, go to **Scanners Symbologies > Internal Scanner > Symbologies**.
- 5 Select a symbology and modify its parameters.
- 6 Tap  to save your settings and tap **X** to exit Intermec Settings. The Scanner Symbologies window appears.
- 7 Tap **Back**.
- 8 Scan bar code labels.

Using Transcriber

In a program that accepts writing, such as Microsoft WordPad, you can use your stylus to write directly on the screen. Write the way you do on paper (print or cursive) and the Transcriber program converts your writing to text.

To turn on Transcriber

- Double-tap the **Transcriber** shortcut on the desktop or go to **Start > Programs > Transcriber**.

The Transcriber Intro box appears and an icon () appears in the taskbar with a dark gray background.

To turn off Transcriber

- Tap the **Transcriber** icon in the taskbar.

The background of the Transcriber icon turns light gray to match the taskbar and using the stylus does not produce a line on your desktop.

To close Transcriber

- 1 Tap and hold the **Transcriber** icon in the taskbar until the menu appears.
- 2 Tap **Close Transcriber**.

To select text

- 1 Tap and hold the stylus next to the text you want to select until the insertion point appears.
- 2 Without lifting, drag the stylus across the text you want to select.

To get help for Transcriber

- 1 Tap and hold the **Transcriber** icon in the taskbar until the menu appears.
- 2 Tap **Help**. The help system for Transcriber appears on the screen.

Calibrating the Screen

If the screen does not respond when you tap it with the stylus, you may need to recalibrate the screen.

To calibrate the screen on a CN2 with the numeric keypad

- 1 Press and hold the **Orange** (■□) key and then press **Enter**. Release both keys. The calibration screen appears.
- 2 Follow the instructions to calibrate the screen.

To calibrate the screen on a CN2 with the scroll keypad













- 1 Press and hold the **Orange** (■□) key and then press ▲. Release both keys. The calibration screen appears.
- 2 Follow the instructions to calibrate the screen.

Understanding the Screen Icons





The screen icons on the taskbar show you battery status, network connections, applications, and special keys or functions you are using.

Standard Microsoft icons are not included in this table.

CN2 Screen Icons

Icon	Description
	Battery is charging.
	Battery is low. Charge the battery soon.
	Battery is critically low. Charge the battery now.
	Backup battery is low. Charge the battery now.
	The CN2 is authenticated with a strong connection to the access point.
	The CN2 is authenticated with a good connection to the access point.
	The CN2 is authenticated with a weak connection to the access point. Try moving closer to an access point.
	No connection to the access point. For help, see “Problems with Wireless Connectivity” on page 88.
	Green mode is enabled and locked. You must press  again to disable Green mode.
	Orange mode is enabled.
	Caps Lock feature on the input panel is enabled.
	The CN2 is connected using ActiveSync.



Note: , , , and  are all versions of the **Network Connection** icon. Each version indicates a different network connection state.

Chapter 1 — Using the CN2 Handheld Computer

Only two screen icons are visible at one time. You can tap the right arrow or left arrow to view additional icons, which are on but not visible.

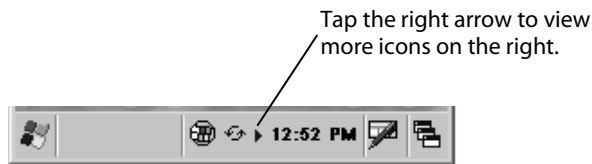

Tap the Right Arrow: The CE Remote Display icon and the ActiveSync icon are visible on the taskbar. Tap the right arrow to view additional icons.

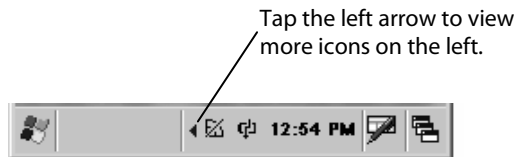

Tap the Left Arrow: The Network Connection icon and the Battery Charging icon are visible on the taskbar. Tap the left arrow to view additional icons.

Understanding the Status Lights

The status lights on the CN2 turn on to indicate the status of the battery or a successful decode of a bar code.

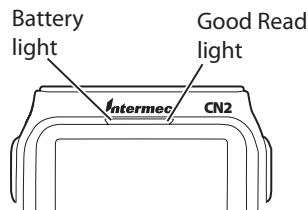

CN2 Status Lights: This illustration shows the location of the Battery and Good Read lights.

The next table describes the status lights.

Understanding the CN2 Status Lights

Light	Color	Description
Good Read	Green	This light turns on when the CN2 successfully decodes a bar code.
	Red	This light turns on when you press one of the Side Scan buttons or the Scan button on the scroll keypad.
Battery	Green	When the CN2 is connected to a power source, this light turns on to indicate that the battery is fully charged.
	Orange	When the CN2 is connected to a power source, this light turns on if you cannot charge the battery. The temperature may not be within the charging range, or the battery may be damaged.
	Red	When the CN2 is connected to a power source, this light turns on to indicate that the battery is charging.

Understanding the Beeps

The CN2 uses beeps to provide you with audio feedback when it performs some functions. For example, you hear a beep each time you scan a valid bar code.

Understanding the CN2 Beeps

Beep Sequence	What it Means
High beep, low beep	You entered valid data or a valid command, the CN2 decoded a label, or the CN2 decoded the last row of a two-dimensional bar code.
Error beep	You entered or scanned an invalid command. Try entering or scanning the command again.
Click	You pressed a key.

Chapter 1 — Using the CN2 Handheld Computer

You can change the beeper volume for your needs and environment. You can set the beeper volume to off, low (quiet), medium, high (loud), and very high (very loud – default setting).

To change the beeper volume

- 1 Tap the **Start** icon and tap **Intermec Settings**. The Intermec Settings application appears.
- 2 Tap **Device Settings > Beeper > Volume**.
- 3 Select a volume level.
- 4 Tap  to save your settings and tap **X** to exit Intermec Settings.

Scanning Bar Codes

Use the scanner to scan and enter bar code data. The CN2 supports the scanning of 1D linear bar codes.

When you unpack the CN2, all the supported bar code symbologies are enabled:

- Codabar
- Code 39
- Code 128
- Interleaved 2 of 5
- UPC/EAN
- MSI

Use Intermec Settings to enable and disable symbologies. For help using Intermec Settings, see “Configuring the CN2 Locally With Intermec Settings” on page 32.

To scan a bar code label with the CN2

- 1 Press the **Power** key to turn on the CN2.
- 2 Point the scanner window at the bar code label and hold the computer at a slight angle 15 to 25 cm (6 to 10 in) from the label.

Chapter 1 — Using the CN2 Handheld Computer

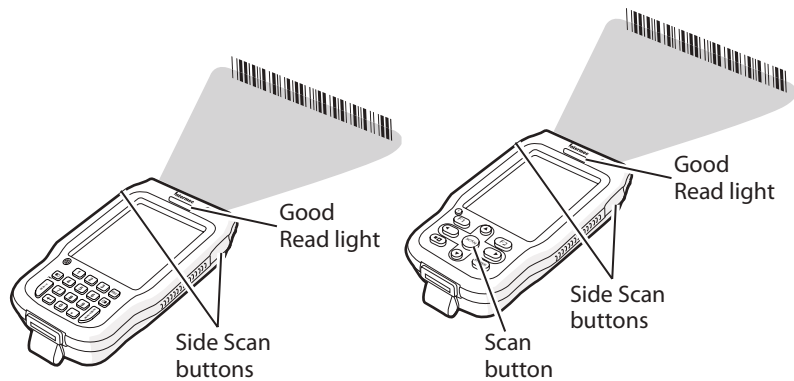

- 3 Press one of the **Side Scan** buttons or the **Scan** button on the scroll keypad and center the red beam so that it falls across all bars in the bar code label.

Use this test bar code:

Code 39 Test Bar Code



123456

- 4 Release the **Side Scan** button or **Scan** button.

Using the Optional SD Card

You can use a SanDisk secure digital (SD) card to increase file storage and install software. The SD card slot is located under the CN2 battery.



Note: The CN2 currently supports SanDisk SD cards only. Intermec cannot guarantee that other SD cards will work with the CN2.

The following procedures explain how to insert an SD card, access the files on an SD card, and remove an SD card.

To insert the SD card

- 1 Before inserting the SD card, you must attach one of the pull-tabs that ships with the CN2. An SD card without a pull-tab can be very difficult to remove.

Chapter 1 — Using the CN2 Handheld Computer

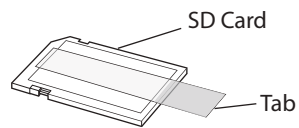

- 2 Align the SD card as shown in the next illustration, and insert the SD card into the slot.

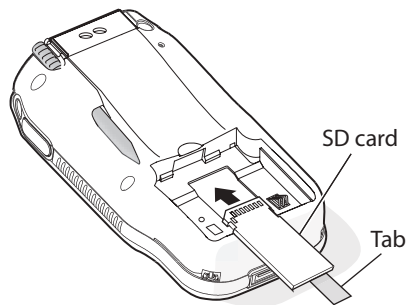

- 3 Push the card into the slot until it is fully inserted.

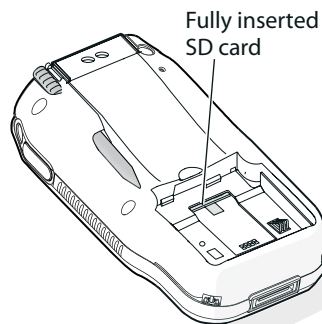

- 4 Align the battery contacts as shown in the next illustration, and insert the battery in the battery compartment. Press down on the battery until it clicks into place.

Chapter 1 — Using the CN2 Handheld Computer

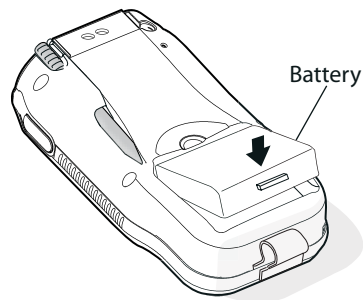

- 5 Install the battery door.

To access files stored on the SD card

- If you have an SD card inserted in your CN2, it appears as the SDMMC Disk folder. To access this folder, double-tap the **My Computer** icon on the desktop and then double-tap the SDMMC Disk folder. You can copy files to and from this folder just as you would any other folder on the CN2.

To remove the SD card

- 1 Press and hold the **Power** key for 2 to 3 seconds, and then release the **Power** key to turn off the CN2.
- 2 Place the CN2 face-down on a clean, flat, stable surface.
- 3 Push down on the battery door latch, and pull up on the battery door.

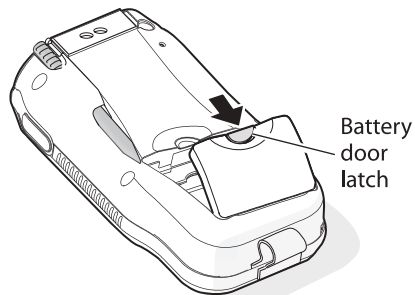

- 4 Remove the battery door and set it aside.
- 5 Insert the stylus between the battery and the CN2 case, and press straight down until the battery is released.

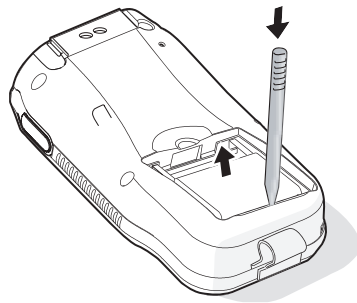

6 Remove the battery and set it aside.

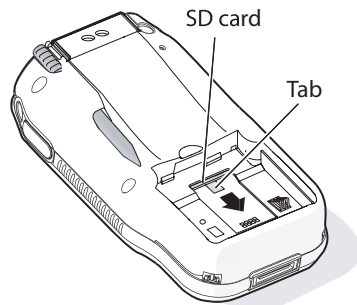

7 Pull the tab toward the bottom on the CN2 to remove the SD card.

Using the Optional USB Keyboard

If you prefer the convenience of using a keyboard with the CN2, you can attach a USB keyboard to the optional modem dock.

You need these items:

- CN2 modem dock (P/N 075499)
- CN2 power supply (P/N 074246)
- Dell Model SK-8115 USB keyboard
or Logitech Model Y-BF37 USB keyboard



Note: The CN2 supports only the Dell Model SK-8115 and Logitech Model Y-BF37 USB keyboards. Intermec cannot guarantee that other USB keyboards will work with the CN2.

Chapter 1 — Using the CN2 Handheld Computer

To attach the USB keyboard

- 1 Read the *CN2 Modem Dock Quick Start Guide* (P/N 075481).
- 2 Connect the USB keyboard to the keyboard port on the modem dock.

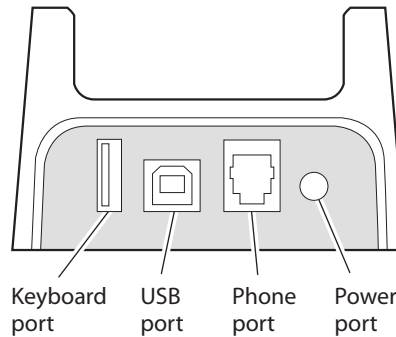

- 3 Connect the AC power supply (P/N 074246) to the power port on the modem dock. Then connect the AC power supply to an AC power source.



You must use only the Intermec power supply approved for use with the CN2. Using any other power supply will damage the CN2.

Attention: Vous devez utiliser seulement le bloc d'alimentation Intermec désigné pour le CN2. L'utilisation d'autre blocs d'alimentation endommagera le CN2.



Note: If you cannot connect the modem dock to an AC power source, you can configure the CN2 to use its battery to power the USB keyboard. In Step 4c, set **USB Host Power** to **Always On**. However, you will have to charge the CN2 battery more often.

- 4 Configure the CN2 to provide power to the keyboard:
 - a Tap **Start** > **Settings** > **Control Panel**.
 - b Double-tap the **Utilities** icon.
 - c Set **USB Host Power** to **On When Powered**.

Chapter 1 — Using the CN2 Handheld Computer

- d Tap **OK** to close the Utilities window.
- e Tap **X** to close the Control Panel window.
- 5 Place the CN2 into the modem dock.
- 6 Open an application like WordPad and begin typing. If the characters you type do not appear on screen, see page 85 for troubleshooting ideas.

To use the USB keyboard

- Type just as you would on a standard keyboard. You may use standard Windows keyboard shortcuts, such as **Ctrl-S** to save a file.



Note: When you tap some input fields, the Software Input Panel (or soft keyboard) appears on your CN2 screen. You can ignore this soft keyboard and continue typing on the USB keyboard.

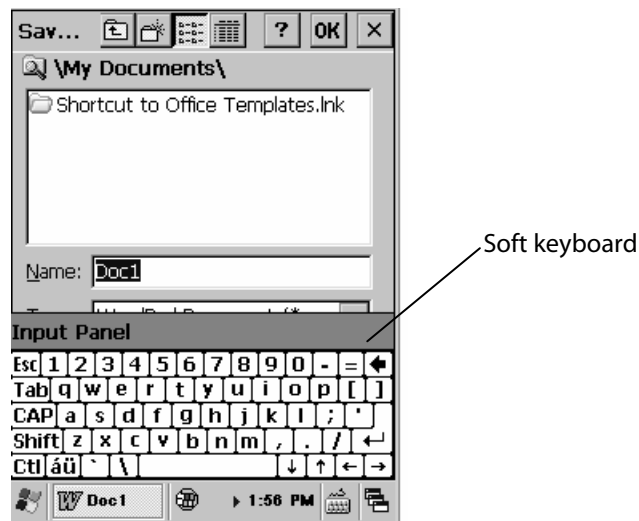

Soft Keyboard: The soft keyboard automatically appears when you tap **File > Save** in a WordPad document even if there is a USB keyboard connected to the CN2.

Chapter 1 — Using the CN2 Handheld Computer



2 Configuring the CN2

Use this chapter to understand how to configure the CN2. In this chapter, you will find these sections:

- How to Configure the CN2 Parameters
- Configuring the CN2 With the Setup Assistant
- Configuring the CN2 Locally With Intermec Setting
- Configuring the CN2 Remotely With Intermec Settings

How to Configure the CN2 Parameters

You can configure many parameters on the CN2, such as the bar code symbologies it decodes or the network settings. These characteristics are controlled by configuration parameters. The values you set for these configuration parameters determine how the computer operates.

There are several ways to configure the CN2:

Use Setup Assistant



Use Setup Assistant to quickly enter network parameters.

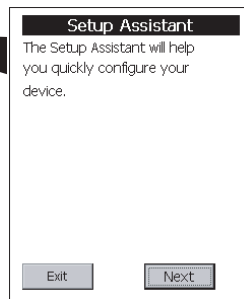

Use Intermec Settings Remotely

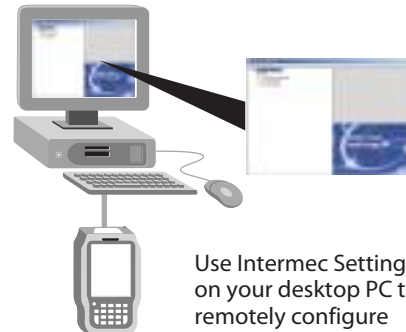

Use Intermec Settings on your desktop PC to remotely configure network parameters.

Use Intermec Settings Locally



Use Intermec Settings on the CN2 to set most parameters.

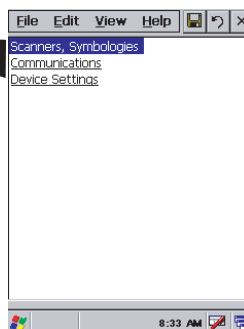

Configuring the CN2: The CN2 provides several ways for you to configure the communications, device, and imaging parameters.

Configuring the CN2 With the Setup Assistant



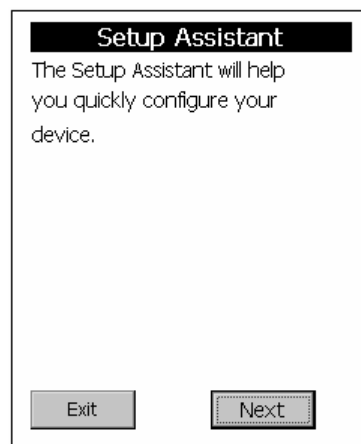

The Setup Assistant runs on the CN2 the first time you turn on the computer. Use the Setup Assistant to set or enable basic network parameters and connect your CN2 to the network. The Setup Assistant guides you through setting the following basic network parameters:

- Date and time
- 802.11b/g radio and SSID (Network name)
- 802.1x security
- DHCP server or IP address, subnet mask, and default router
- Primary and secondary DNS addresses
- Primary and secondary WINS addresses
- Device name

To set other parameters, use Intermec Settings or another configuration method.



The Setup Assistant Start Screen

After you complete the Setup Assistant, the CN2 should be communicating with your network. A **Network Connection** icon (   or ) appears on your taskbar. For more information on the network icons, see “Understanding the Screen Icons” on page 18.

Configuring the CN2 Locally With Intermec Settings

Use Intermec Settings to configure the CN2 and view system information. You can access Intermec Settings while running any application.

Opening Intermec Settings

To open Intermec Settings

- 1 Tap the **Start** icon. The **Start** menu appears.

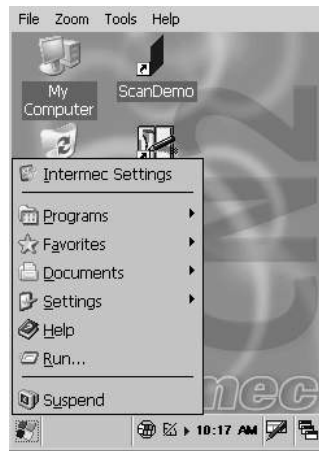

- 2 Tap **Intermec Settings**. The Intermec Settings application appears.

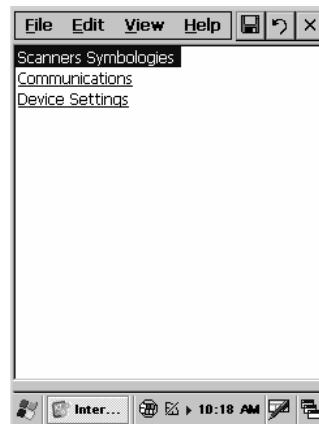

Chapter 2 — Configuring the CN2

- 3 Make changes to the settings as necessary. For help, see the next section, “Navigating Through Intermec Settings.”
- 4 Save your changes. For help, see “Saving Your Settings” on page 34.
- 5 Exit Intermec Settings. For help, see “Exiting Intermec Settings” on page 35.

Navigating Through Intermec Settings

Use this table to understand how to navigate and enter information in Intermec Settings.

Navigating in Intermec Settings

Function	Choose a Method
Select or expand an option	<ul style="list-style-type: none">• Tap the option.• On the scroll keypad, press ▲ or ▼ to select an option.
Expand an option	<ul style="list-style-type: none">• Tap the option.• On the scroll keypad, press ▲ or ▼ to select the option, and then press ►.
Enter information	<ul style="list-style-type: none">• Tap in the text box. The soft keyboard appears. Tap the keyboard keys to enter information. Tap outside the box or tap Enter when you are finished.
Select text in a text box	<ul style="list-style-type: none">• Tap in the text box and drag the stylus over the text.
Save settings	<ul style="list-style-type: none">• Tap File > Save Settings.• Tap the Save icon in the upper right corner.

Use the following diagram to help find the commands you need to use to configure your CN2. These screens do not represent the exact information you will see on your CN2. They have been modified to show you how the information is structured.

For detailed information on most of the commands available in Intermec Settings, see the *Intermec Computer Command Reference Manual* (P/N 073529) available from the Intermec web site at www.intermec.com.

Chapter 2 — Configuring the CN2

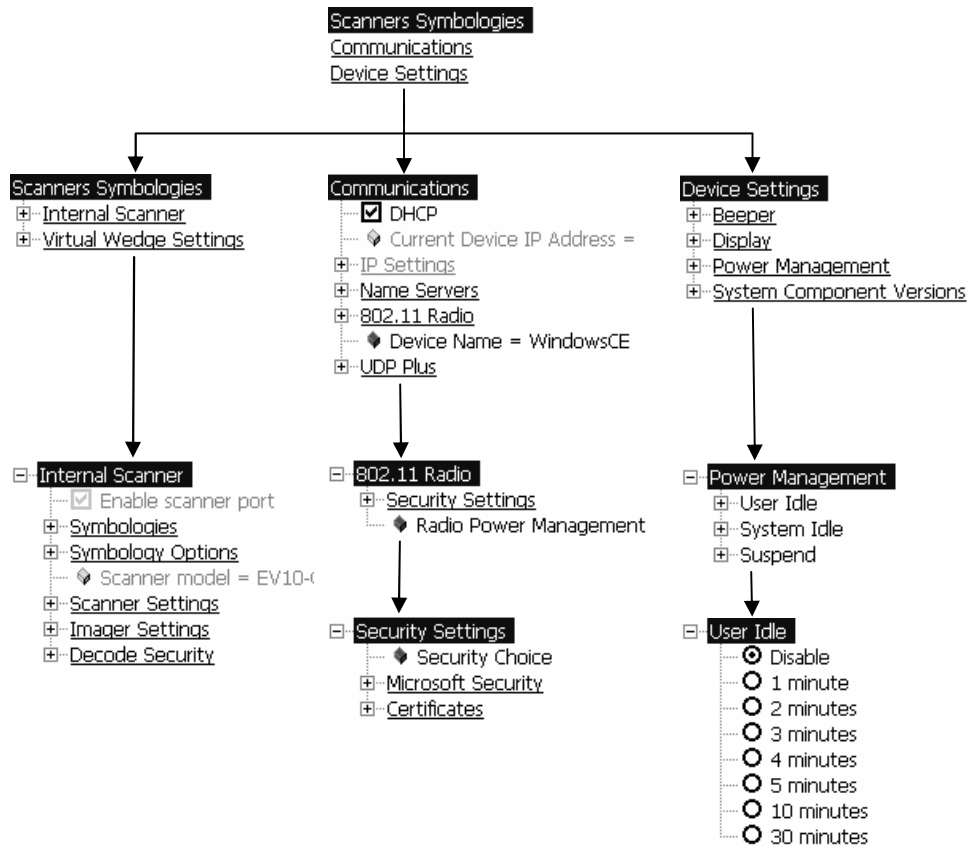

Intermec Settings Menus: Use this diagram to help navigate through the Intermec Settings application. This diagram should only be used as a guide; it does not accurately represent all of the information you will see on your screen.

Saving Your Settings

You can save the changes you make in Intermec Settings at any time. After you save your changes, you can continue making changes or you can exit Intermec Settings.

To save your settings

- Tap the **Save** icon  at the top of the screen.

Or,

- From the Main Menu, tap **File > Save Settings**.

Exiting Intermec Settings

When you are done modifying your device configuration and have saved your settings, you should exit Intermec Settings.

To exit Intermec Settings

- Tap the **X** in the upper right corner of the window.
- Or,
- From the Main Menu, tap **File > Exit**.

If you try to exit Intermec Settings without saving your changes, a message box appears asking if you want to save your configuration changes. Tap **Yes**.

Restoring the CN2 Default Settings

You can restore the CN2 to factory default settings.



Note: Restoring the CN2 to factory default settings resets all network parameters. As a result, you may lose network communications. This option should only be used by network administrators or by Intermec support personnel.

For a complete list of the default settings, see “Default Configuration” on page 108.

To restore default settings

- 1 Tap **Start > Intermec Settings**. The Intermec Settings application appears.
- 2 Tap one of the menus:
 - **Scanners Symbologies**
 - **Communications**
 - **Device Settings**
- 3 Tap **Edit > Restore Item Defaults**.
- 4 Tap **Yes** to restore all default settings.
- 5 Repeats Steps 2, 3, and 4 for the other two menus.

Chapter 2 — Configuring the CN2

- 6 Tap **Scanners Symbologies > Internal Scanner > Symbologies** and make sure every bar code symbology that you need is enabled.
- 7 Tap  to save your settings.
- 8 Tap **X** to exit Intermec Settings.



Note: You can also return the CN2 to its default software configuration by resetting the registry and clearing the object store. For instructions, see page 86.

Configuring the CN2 Remotely With Intermec Settings

You can use Intermec Settings remotely to configure your CN2. The remote version of Intermec Settings provides these features:

- Intermec Settings can configure CN2s one-to-one through an ActiveSync connection.
- Intermec Settings can run as a plug-in to the Wavelink Avalanche device management system. Avalanche automates device management within a network and lets you install, update, and manage the software and configurations of wireless and other devices.

The ActiveSync (one-to-one) version of Intermec Settings is available from the Intermec web site as part of the Intermec Developer's Library (IDL) download or from the IDL CD. For information on installing ActiveSync and establishing a partnership, see "Installing Applications Using ActiveSync" on page 76.

For more help using Intermec Settings, see the online manual available from the Help menu in Intermec Settings.



3 Adding the CN2 to the Network

Use this chapter to understand how to configure the CN2 to communicate in your network. In this chapter, you will find these sections:

- Configuring the CN2 for Your Network
- Configuring Network Security
- Using the Modem Dock for Internet Access and E-mail

Configuring the CN2 For Your Network

The CN2 is a versatile handheld computer that you can easily add to your wired or wireless data collection network. You can connect your CN2 to your network using:

- USB communications
- 802.11b/g radio communications

Configuring USB Communications

You can place the CN2 in the modem dock (P/N 075499) or the communications dock (P/N 225-696-001) to transfer data to, and receive data from, another device using USB communications. The USB cable, communications dock, and modem dock are sold separately. For more information on accessories and how to order them, see page 105.

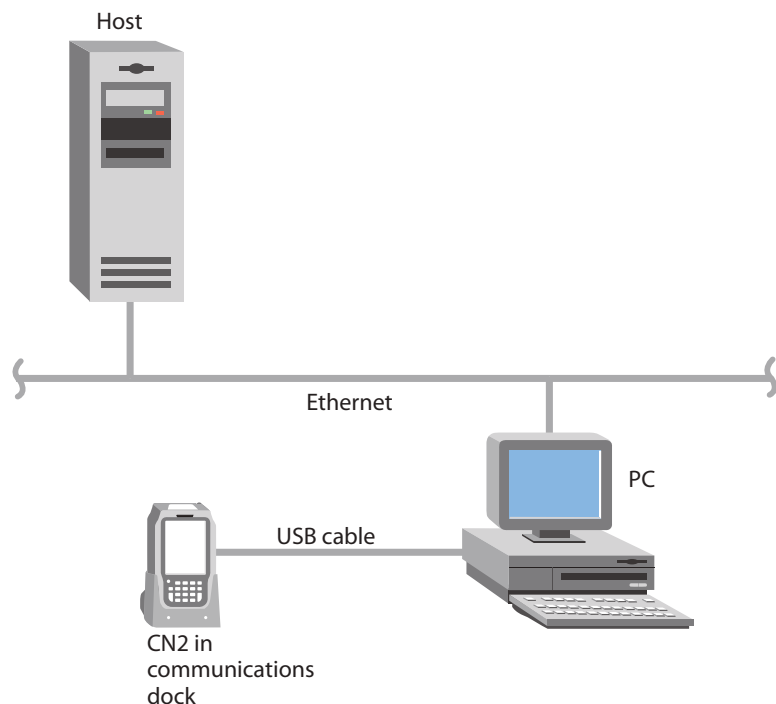

CN2 Using USB Communications

To use USB communications with your CN2

- 1 Connect the communications dock to the USB port of the other device using an appropriate USB cable.
- 2 Make sure that your USB device is configured for USB communications.
- 3 Insert the CN2 into the communications dock.
- 4 Turn on the CN2.

For more information about the communications dock, see the instructions that ship with the communications dock.

Configuring 802.11b/g Radio Communications



Make sure all components with antennas are at least 30 cm (1 ft) apart when power is applied. Failure to comply could result in equipment damage.

Attention: Assurez-vous que la distance entre tous les éléments avec antennes soit d'au moins 30 centimètres (un pied) avant de faire la connexion avec l'alimentation électrique, faute de quoi vous risquez d'endommager votre installation.

The wireless CN2 has an internal 802.11b/g radio to transfer data using wireless communications. This section of the manual assumes that you have already set up your wireless communications network including your access points. If you are using a UDP Plus network, you also need to have your Intermec Application Server communicating with a host computer.

Your CN2 supports these network protocols:

- TCP/IP
- UDP Plus

The next sections explain the parameters you need to configure for the CN2 to work in your wireless network.

Chapter 3 — Adding the CN2 to the Network

Configuring the Network Parameters for a TCP/IP Network

In a TCP/IP network, the CN2 communicates with a host computer directly using TCP/IP. The access point acts as a bridge to allow communications between the wired network and the wireless network.

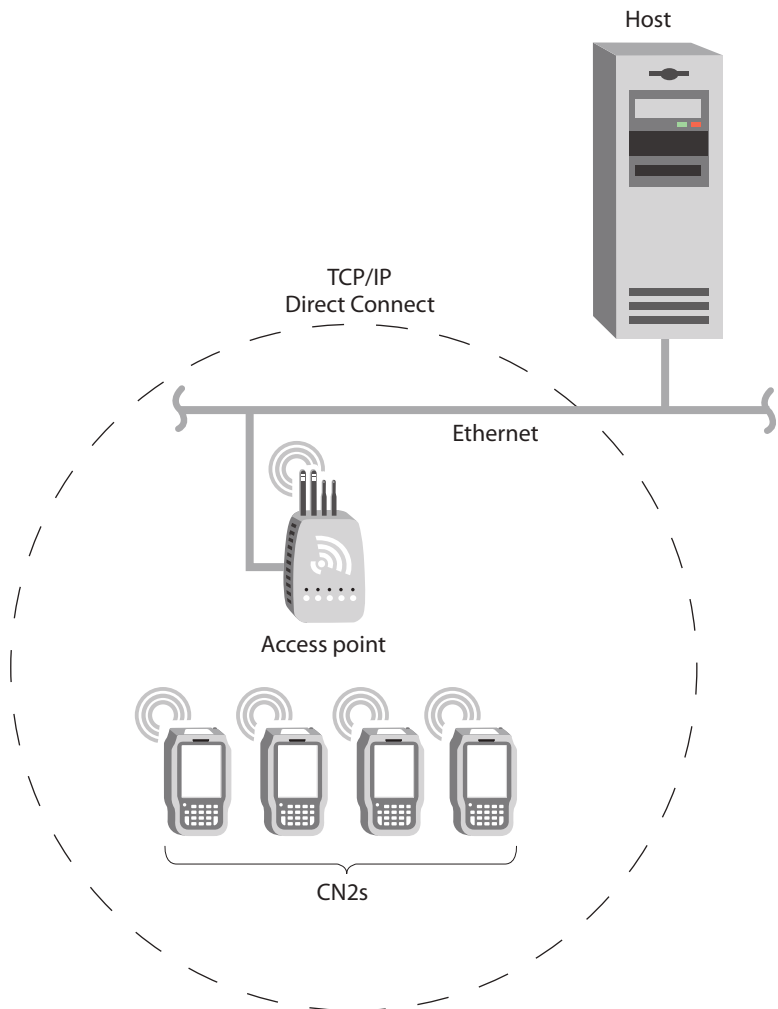

CN2s in a TCP/IP Direct Connect Network

Chapter 3 — Adding the CN2 to the Network

To use wireless communications in a TCP/IP network

- 1** Configure these network parameters on each CN2 in the network:
 - Infrastructure mode (set to Infrastructure by default)
 - Network name (SSID)
 - Host IP address
 - IP settings (if not using DHCP)
- 2** Configure security. For help, see “Configuring Network Security” on page 45.

The easiest way to configure the network parameters on the CN2 is to use Intermec Settings. For help, see “Configuring the CN2 Locally With Intermec Settings” on page 32.

Chapter 3 — Adding the CN2 to the Network

Configuring the Network Parameters for a UDP Plus Network

In a UDP Plus network, the CN2 communicates with a host computer through the Intermec Application Server.

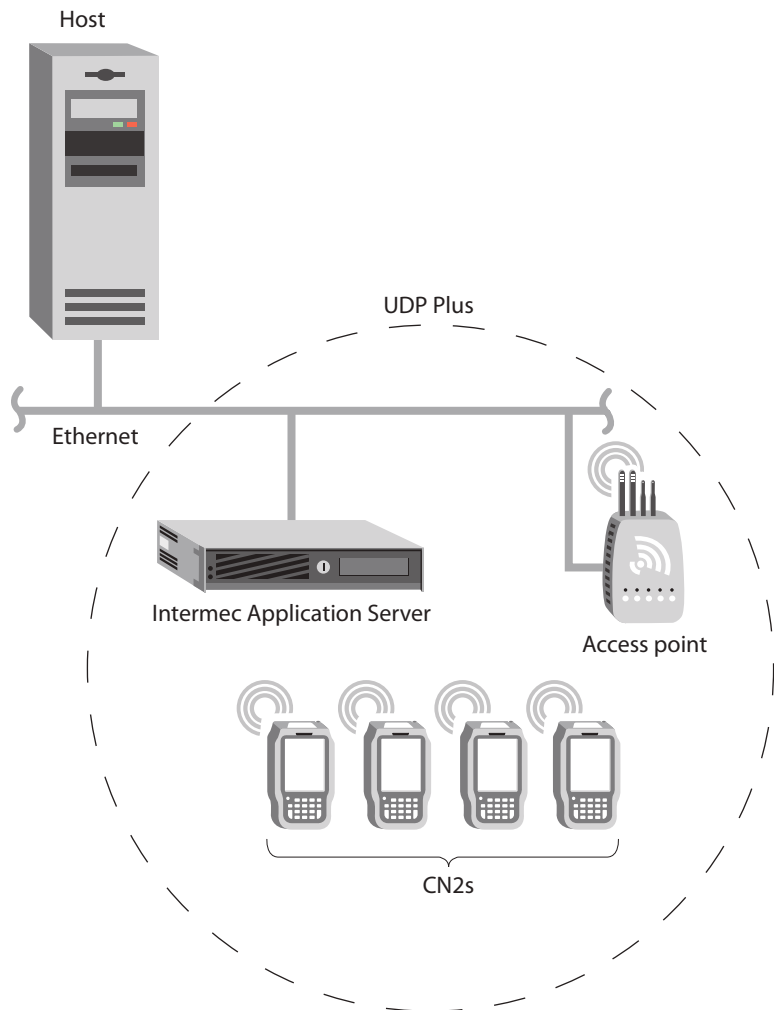

CN2s in a UDP Plus Network

Chapter 3 — Adding the CN2 to the Network

The Intermec Application Server translates UDP Plus packets on the wireless network into TCP/IP packets on the wired network and vice versa. The access point acts as a bridge to allow communications between the wired network and the wireless network.

To use wireless communications in a UDP Plus network

- 1 Configure these network parameters on each CN2 in the network:
 - Network name (SSID)
 - Controller IP address
 - IP settings (if not using DHCP)
 - Controller port (set to 5555)
- 2 Configure the security. For help, see “Configuring Network Security” on page 45.

The easiest way to configure the network parameters on the CN2 is to use Intermec Settings. For help, see “Configuring the CN2 Locally With Intermec Settings” on page 32.

Configuring the CN2 for Microsoft Wireless Zero Configuration

You can use Microsoft Wireless Zero Configuration with your wireless CN2. Wireless Zero Configuration gives you a convenient way to view wireless network parameters and a list of available wireless networks.

To use Wireless Zero Configuration on your CN2

- 1 Tap **Start > Intermec Settings > Communications > 802.11 Radio > Security Settings** and make sure that **Security Choice** is set to **Microsoft Security**.

If **Security Choice** is set to **Funk Security**, select **Microsoft Security**, save your settings, and warm boot the CN2. For help, see “Warm Booting the CN2” on page 94.



Note: You must warm boot the CN2 after you change your security choice.

Chapter 3 — Adding the CN2 to the Network

- 2 You must use Intermec Settings to configure all the wireless network parameters for Microsoft Security. Save your settings. For help, see the next section, “Configuring Network Security.”
- 3 Double-tap the **Network Connection** icon (📶 or 📶) in the taskbar. The SWLD26C1 configuration screen appears.

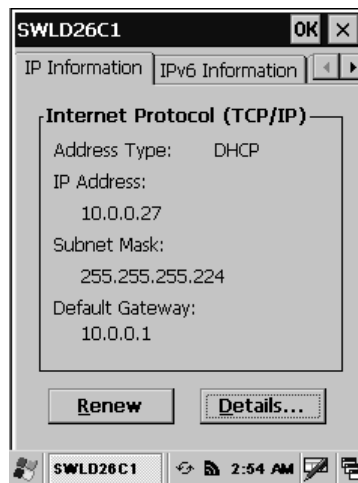

- 4 Tap the right arrow button (▶) twice and then tap the **Wireless Information** tab to bring the tab forward.

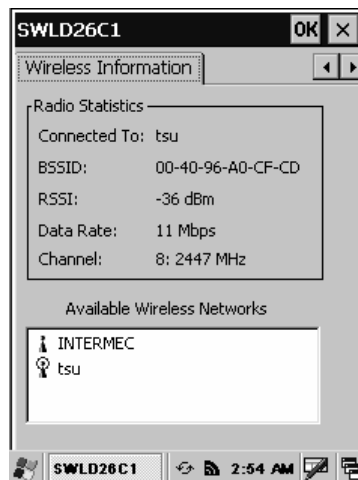



Note: The **Wireless Information** tab lets you view wireless network parameters and a list of available wireless networks. You cannot set parameters or select a network on this tab.

- 5 Tap **OK** to close the SWLD26C1 configuration screen.

Configuring Network Security

The CN2 provides three types of security for your wireless network:

- Wi-Fi Protected Access (WPA)
- 802.1x
- WEP

This section explains how to configure security on your wireless CN2. If you choose not to use security, see “Disabling Security” on page 62. Intermec always recommends that you implement security.

You must use either Microsoft Security or Funk Security software to implement your security solution. For details, see the next section, “Choosing Between Microsoft Security and Funk Security Software.”



Note: If you are using 802.1x security, this section assumes that your authentication server and authenticators are properly configured. For more information on the different types of security, see the *MobileLAN™ secure 802.1x Security Solution Installation Guide* (P/N 073134) available at www.intermec.com.

Choosing Between Microsoft Security and Funk Security Software

Before you can implement a security solution on the CN2, you need to choose between Microsoft Security and Funk Security software:

- Microsoft Security is the default setting. If you choose Microsoft Security, you can begin implementing your WPA, 802.1x, or WEP security solution now.

Chapter 3 — Adding the CN2 to the Network

- In addition to everything offered by Microsoft Security, Funk Security offers you CCX v1.0 compliance and lets you use LEAP and TTLS authentication on your CN2. If you choose Funk security, follow the instructions in these sections:
 - “Selecting Funk Security as Your Security Choice” in the next section
 - “Selecting a Profile for Funk Security” on page 47



Note: If you choose Microsoft Security, you can use Microsoft Wireless Zero Configuration. For details, see “Configuring the CN2 for Microsoft Wireless Zero Configuration” on page 43.



Note: Your choice does not depend on your authentication server. For example, you can choose Funk Security if you use Microsoft Active Directory® to issue certificates.

Selecting Funk as Your Security Choice

The default security setting is Microsoft. If you want to use Funk security, you need to select it as your security choice.

To select Funk security as your security choice

- 1 Tap the **Start** icon. The Start menu appears.
- 2 Tap **Intermec Settings**. The Intermec Settings application appears.
- 3 Tap **Communications > 802.11 Radio > Security Settings > Security Choice**.
- 4 From the **Security Choice** list, select **Funk Security**.
- 5 Tap the **Save** icon  at the top of the screen. An alert box appears telling you that you must save your settings and warm boot the CN2 for your new security choice to take effect.
- 6 Tap **OK** to close the alert box.
- 7 Save your settings.
- 8 Warm boot your CN2 by pressing and holding the **Power** key for approximately 10 seconds.



Note: You must warm boot the CN2 after you change your security choice.

Selecting a Profile for Funk Security

You can define up to four profiles for your Funk security. Different profiles let your CN2 communicate in different networks without having to change all of your security settings. For example, you may want to set up one profile for the manufacturing floor and one for the warehouse.

To select a profile for Funk security

- 1 Tap the **Start** icon. The Start menu appears.
- 2 Tap **Intermec Settings**. The Intermec Settings application appears.
- 3 Tap **Communications > 802.11 Radio > Security Settings > Funk Security**.
- 4 (Optional) Give your Profile 1 a meaningful name.
 - a Select **Profile 1**. The profile expands.
 - b Select **Profile Label** and a text box appears.
 - c Select the text in the box and use the input panel to type in your meaningful name.
 - d Tap the **Save** icon  at the top of the screen.
- 5 (Optional) Modify more profiles.
 - a Tap **Active Profile**.
 - b Select the profile that you want to modify and tap anywhere on the screen.
 - c Repeat Step 4.
- 6 Repeat Step 5 for as many profiles as you want to define.
- 7 Select the active profile you want to configure with security settings.
- 8 Configure your security settings.

Switching from Funk Security to Microsoft Security

If your CN2 is configured to use Funk Security, it is easy to switch to Microsoft Security.

To switch to Microsoft Security

- 1 Tap **Start > Intermec Settings > Communications > 802.11 Radio > Security Settings**.
- 2 For **Security Choice**, choose **Microsoft Security**.
- 3 Save your settings.
- 4 Warm boot the CN2. For help, see “Warm Booting the CN2” on page 94.



Note: You must warm boot the CN2 after you change your security choice.

Using WPA Security

Wi-Fi Protected Access (WPA) is a strongly enhanced, interoperable Wi-Fi security that addresses many of the vulnerabilities of Wired Equivalent Privacy (WEP). Instead of WEP, WPA uses Temporal Key Integrity Protocol (TKIP) for its data encryption method.

Currently, WPA satisfies some of the requirements in the IEEE 802.11i draft standard. When the standard is finalized, WPA will maintain forward compatibility.

WPA runs in 802.1x (Enterprise) mode or PSK (Pre-Shared Key) mode:

- In Enterprise mode, WPA provides user authentication using 802.1x and the Extensible Authentication Protocol (EAP). That is, an authentication server (such as a RADIUS server) must authenticate each device before the device can communicate with the wireless network.
- In PSK mode, WPA provides user authentication using a shared key between the authenticator and the CN2. WPA-PSK is a good solution for small offices or home offices that do not want to use an authentication server.

Chapter 3 — Adding the CN2 to the Network

To use WPA security, you need:

- an authentication server (Enterprise mode only).



Note: You can also use a MobileLAN access WA2X product as an authentication server. For help, see the *MobileLANaccess WA2X System Manual* (P/N 073915).

- user and root certificates (if you plan to use TLS for authentication)
- an access point with an 802.11b/g radio that supports WPA.
- a CN2 with the 802.11b/g radio and the 802.1x/WPA security option.

Configuring WPA Security With Funk Security

Use these procedures to set WPA-802.1x and WPA-PSK security on your CN2 with Funk security.

To enable WPA-802.1x security on your CN2 with Funk security

- 1 Make sure you have configured the communications and radio parameters on your CN2.
- 2 Make sure you have selected Funk as your security choice, as described in “Choosing Between Microsoft Security and Funk Security Software” on page 45.
- 3 If you plan to use TLS for authentication, load a user and root certificate on your CN2. For help, see “Loading Certificates” on page 59.
- 4 Open Intermec Settings.
- 5 Tap **Communications > 802.11 Radio > Security Settings > Funk Security > Profile**.
- 6 For **Association**, choose **WPA** and tap the **Save** icon in the upper right corner of the screen. **Encryption** is set to **TKIP** by default.
- 7 For **Authentication**, choose **TTLS**, **PEAP**, or **TLS** and tap **Save**.

Chapter 3 — Adding the CN2 to the Network

If you choose TTLS or PEAP:

- a Select **User name**, select the text in the text box, use the input panel to type your user name, and tap **Save**.
- b For **Password prompt**, make sure that **Enter password now** is selected.



Note: You can use **Prompt for password** to troubleshoot your connection to the network if you have problems.

- c Select **User Password**, select the text in the text box, use the input panel to type your user password, and tap **Save**.
- d For **Validate Server Certificate**, choose **Enabled** and tap **Save**.



Note: You must have the date on the CN2 set correctly when you enable **Validate Server Certificate**.

If you choose TLS:

- a For **Validate Server Certificate**, choose **Enabled** and tap **Save**.
- b You must enter a **User Name** and **Subject Name**. You can also enter a **Server Common Name** if you want to increase your level of security.

- 8 Exit Intermec Settings.

To enable WPA-PSK security on your CN2 with Funk security

- 1 Make sure you have configured the communications and radio parameters on your CN2.
- 2 Make sure you have selected Funk as your security choice, as described in “Choosing Between Microsoft Security and Funk Security Software” on page 45.
- 3 Open Intermec Settings.
- 4 Tap **Communications > 802.11 Radio > Security Settings > Funk Security > Profile**.
- 5 For **Association**, choose **WPA** and tap **Save**.
- 6 For **Authentication**, choose **None** and tap **Save**.

Chapter 3 — Adding the CN2 to the Network

- 7 For **Pre-Shared Key**, enter the pre-shared key or the passphrase.

The pre-shared key must be a value of 32 hex pairs preceded by 0x for a total of 66 characters. The value must match the key value on the access point. The passphrase must be from 8 to 63 characters. After you enter a passphrase, the CN2 internally converts it to a pre-shared key.

This value must match the passphrase on the authenticator.

- 8 Exit Intermec Settings.

Configuring WPA Security With Microsoft Security

Use these procedures to set WPA-802.1x and WPA-PSK security on your CN2 with Microsoft security. These procedures assume that you have selected Microsoft Security software as your security choice, as described in “Choosing Between Microsoft Security and Funk Security Software” on page 45.

To enable WPA-802.1x security on your CN2 with Microsoft security

- 1 Make sure you have configured the communications and radio parameters on your CN2.
- 2 If you plan to use TLS for authentication, load a user and root certificate on your CN2. For help, see “Loading Certificates” on page 59.
- 3 Open Intermec Settings.
- 4 Tap **Communications > 802.11 Radio > Security Settings > Microsoft Security**.
- 5 For Infrastructure Mode, choose **Infrastructure**.
- 6 For **Network Authentication**, choose **WPA** and tap the **Save** icon in the upper right corner of the screen. **Data Encryption** is set to **TKIP** by default.
- 7 For 802.1x Authentication, choose either **TLS** or **PEAP**.
If you choose TLS:
 - a Tap **Properties** and tap **Run App**. The Authentication Settings box appears.

Chapter 3 — Adding the CN2 to the Network



- b** From the Authentication Settings box, tap **Select**.
- c** Tap your certificate from the list and tap **Enter**.

If you choose PEAP:

- a** Tap **Properties** and tap **Run App**. The Authentication Settings box appears.
- b** Tap the **Validate Server** check box.
- c** Tap **Enter**. After the radio starts to authenticate, the Network Password dialog box appears:

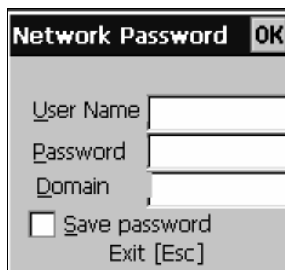

- d** Enter a **User Name** and **Password** and tap the **Save Password** check box.
 - e** (Optional) In the **Domain** field, enter the Active Directory domain associated with the user account.
 - f** Press **Enter**.
- 8** Exit Intermec Settings.

To enable WPA-PSK security on your CN2 With Microsoft security

- 1** Make sure you have configured the communications and radio parameters on your CN2.

Chapter 3 — Adding the CN2 to the Network

- 2 If you plan to use TLS for authentication, load a user and root certificate on your CN2. For help, see “Loading Certificates” on page 59.
- 3 Open Intermec Settings.
- 4 Choose **Communications > 802.11 Radio > Security Settings > Microsoft Security**.
- 5 For **Infrastructure Mode**, choose **Infrastructure**.
- 6 For **Network Authentication**, choose **WPA-PSK** and tap the **Save** icon in the upper right corner of the screen. **Data Encryption** is set to **TKIP** by default.
- 7 For **Pre-Shared Key**, enter the pre-shared key or the passphrase.

The pre-shared key must be a value of 32 hex pairs preceded by 0x for a total of 66 characters. The value must match the key value on the authenticator. The passphrase must be from 8 to 63 characters. After you enter a passphrase, the CN2 internally converts it to a pre-shared key.

This value must match the passphrase on the authenticator.

- 8 Exit Intermec Settings.

Using 802.1x Security

802.1x security provides centralized user authentication using an authentication server, authenticators (access points), and supplicants. These components communicate using an EAP authentication type, such as TLS (Transport Layer Security) or PEAP (Protected Extensible Authentication Protocol). 802.1x security provides data encryption using dynamic WEP key management.

To use 802.1x security, you need:

- an authentication server.



Note: You can also use a MobileLAN access WA2X product as an authentication server. For help, see the *MobileLANaccess WA2X System Manual* (P/N 073915).

- an access point with an 802.11b/g radio.

Chapter 3 — Adding the CN2 to the Network

- a CN2 with an 802.11b/g radio and the 802.1x/WPA security option.
- user and root certificates (if you plan to use TLS for authentication)

These procedures assume that you have already selected either Microsoft Security or Funk Security software as your security choice, as described in “Choosing Between Microsoft Security and Funk Security Software” on page 45.

Configuring 802.1x Security With Funk Security

- 1 Make sure you have configured the communications and radio parameters on your CN2.
- 2 Make sure you have selected Funk as your security choice.
- 3 If you plan to use TLS for authentication, load a user and root certificate on your CN2. For help, see “Loading Certificates” on page 59.
- 4 Open Intermec Settings.
- 5 Choose **Communications > 802.11 Radio > Security Settings > Funk Security > Profile**.
- 6 For **Association**, tap **Open** and tap **Save**.
- 7 For **Encryption**, tap **WEP** and tap **Save**.
- 8 For **Authentication**, tap **TTLS**, **PEAP**, or **TLS** and tap **Save**.
If you choose TTLS or PEAP:
 - a Select **User name**, type your user name, and then tap **Save**.
 - b Select **Password prompt**, choose **Enter password now**, and then tap **Save**.



Note: You can use **Prompt for password** to troubleshoot your connection to the network if you have problems.

- c Select **User Password**, type a user password, and then tap **Save**.
- d For **Validate Server Certificate**, choose **Enabled** and tap **Save**.

Chapter 3 — Adding the CN2 to the Network

If you choose TLS:

- a For **Validate Server Certificate**, choose **Enabled** and tap **Save**.
 - b You can also enter a **User Name**, **Subject Name** and **Server Common Name** if you want to increase your level of security.
- 9 Exit Intermec Settings.

Configuring 802.1x Security With Microsoft Security

- 1 Make sure you have configured the communications and radio parameters on your CN2.
- 2 If you plan to use TLS for authentication, load a user and root certificate on your CN2. For help, see “Loading Certificates” on page 59.
- 3 Open Intermec Settings.
- 4 Choose **Communications > 802.11 Radio > Security Settings > Microsoft Security**.
- 5 For **Infrastructure Mode**, choose **Infrastructure**.
- 6 For **Network Authentication**, choose **Open**.
- 7 For **Data Encryption**, choose **WEP**.
- 8 For **802.1X Authentication**, choose **TLS** or **PEAP**, and tap **Save**.

If you choose TLS:

- a Select **Properties** and tap **Run App**. The Authentication Settings box appears.



- b From the Authentication Settings box, tap **Select**.
- c Select your certificate from the list and tap **Save**.

Chapter 3 — Adding the CN2 to the Network

If you choose PEAP:

- a Select **Properties** and tap **Run App**. The Authentication Settings box appears.
- b Select the **Validate Server** check box.
- c Press **Enter**. Once the radio starts to authenticate, the Network Password dialog box appears.

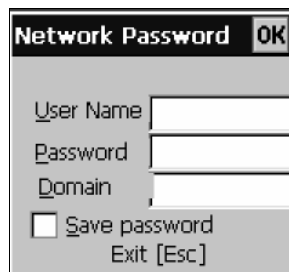

- d Enter a **User Name** and **Password** and select the **Save Password** check box.
 - e (Optional) In the **Domain** field, enter the domain.
 - f Press **Enter**.
- 9 For **Network Key Setting**, choose **Automatic**.
 - 10 Exit Intermec Settings.

Using LEAP Security

Lightweight Extensible Authentication Protocol (LEAP), also known as Cisco-Wireless EAP, provides username/password-based authentication between a wireless client and a RADIUS server. In the 802.1x framework, traffic cannot pass through an Ethernet hub or wireless network access point until it successfully authenticates itself.

The station must identify itself and prove that it is an authorized user before it is actually allowed to use the LAN. LEAP also delivers a session key to the authenticated station, so that future frames can be encrypted with a key that is different than keys used by others' sessions.

To use LEAP security, you need:

- a RADIUS server.

Chapter 3 — Adding the CN2 to the Network

- a Cisco access point with an 802.11b/g radio.



Note: LEAP security is not supported if you chose Microsoft Security software, as described in “Choosing Between Microsoft Security and Funk Security Software” on page 45.

To enable LEAP security on your CN2

- 1 Make sure you have configured the communications and radio parameters on your CN2.
- 2 Make sure you have selected Funk as your security choice, as described in “Choosing Between Microsoft Security and Funk Security Software” on page 45.
- 3 Open Intermec Settings.
- 4 Tap **Communications** > **802.11 Radio** > **Security Settings** > **Funk Security** > **Profile**.
- 5 For **Authentication**, select **LEAP** and then tap **Save**.
- 6 For **Association**, select **Open** or **Network EAP** and then tap **Save**.
- 7 For **Encryption**, select **WEP**, and then tap **Save**.
- 8 Select **User name**, type your user name, and then tap **Save**.
- 9 Select **Password** prompt, choose **Enter password now**, and then tap **Save**.



Note: You can use **Prompt for password** to troubleshoot your connection to the network if you have problems.

- 10 Select **User Password**, type a user password, and then tap **Save**.
- 11 Exit Intermec Settings.

Using Static WEP Security

The CN2 uses the Wired Equivalent Privacy (WEP) protocol to add security to your wireless network based on the 802.11b standard.

Chapter 3 — Adding the CN2 to the Network

To use WEP security, you need:

- an access point with an 802.11b/g radio.
- a CN2 handheld computer with an 802.11b/g radio.

Configuring Static WEP Security With Funk Security

- 1 Make sure you have configured the communications and radio parameters on your CN2.
- 2 Make sure you have chose Funk Security software as your security choice, as described in “Choosing Between Microsoft Security and Funk Security Software” on page 45.
- 3 Open Intermec Settings.
- 4 Tap **Communications > 802.11 Radio > Security Settings > Funk Security > Profile**.
- 5 For **Association**, choose **Open**, and then tap **Save**.
- 6 For **Encryption**, choose **WEP** and then tap **Save**.
- 7 For **Authentication**, choose **None** and then tap **Save**.
- 8 Select **WEP Key** and then define a value for each WEP key. You can define up to four WEP keys.

Enter an ASCII key or a hex key that is either 5 bytes or 13 bytes long depending on the type of WEP encryption you are using. Set a 5-byte value for 64-bit WEP or a 13-byte value for 128-bit WEP. Hex values must be preceded by 0x and contain 5 or 13 hex pairs.

- 9 Select **Network Key Index**, choose the WEP key you want to use for transmitting data.
- 10 Exit Intermec Settings.

Configuring Static WEP Security With Microsoft Security

- 1 Make sure you have configured the communications and radio parameters on your CN2.
- 2 Make sure you have selected Microsoft as your security choice, as described in “Choosing Between Microsoft Security and Funk Security Software” on page 45.
- 3 Open Intermec Settings.

Chapter 3 — Adding the CN2 to the Network

- 4 Choose **Communications > 802.11 Radio > Security Settings > Microsoft Security**.
- 5 For **Network Authentication**, choose **Open**.
- 6 For **Data Encryption**, choose **WEP**.
- 7 For **Network Key Setting**, choose **Enter Key and Index**.
- 8 For **Network Key Value**, enter an ASCII key or a hex key that is either 5 bytes or 13 bytes long depending on the type of WEP encryption you are using.

Set a 5-byte value for 64-bit WEP or a 13-byte value for 128-bit WEP. Hex values must be preceded by 0x and contain 5 or 13 hex pairs.
- 9 For **Network Key Index**, select the key you want to use for data transmission.
- 10 Exit Intermec Settings.

Loading Certificates

If you choose to use transport layer security (TLS) with WPA or 802.1x security, you need to have a unique client certificate on the CN2 and a trusted root certificate authority (CA) certificate. You can use a third-party CA to issue unique client certificates and a root certificate.

If you are using Active Directory® to issue certificates, you can use the Enroll Certificates application to load the certificates. If you are using a third-party CA, you can use the Import Root or User Certificates programs to load the certificates.



Note: Do not cold boot the CN2. Cold booting the computer resets the time and date.

To load certificates on the CN2 if you are using Active Directory

- 1 Configure the network and radio settings for the CN2 to communicate with your certificate authority or establish an ActiveSync connection with the CA.
- 2 Tap **Start > Intermec Settings > Communications > 802.11 Radio > Security Settings > Certificates**.
- 3 Select **Enroll Certificates** and tap **Run App**.

Chapter 3 — Adding the CN2 to the Network

- 4 From the Run Application box, tap **Yes**. The Enroll Certificates dialog box appears.



- 5 Enter the **User Name**, **Password**, and **Server (IP address)** to log in to the CA server.
- 6 Tap **OK**. A dialog box appears asking if you want to load the root certificate.

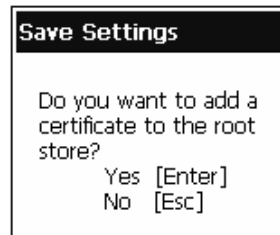

- 7 Press **Enter** for yes. The Enrollment Tool message box appears telling you that the user certificate has been added.
- 8 Press **Enter** to close the Enrollment Tool message box.
- 9 Configure your CN2 for WPA or 802.1x security.

To load certificates on the CN2 if you are using a third-party CA



Note: You need to create the `\temp\root` and `\temp\user` folders on your CN2 before you can copy the certificate files to your handheld computer.

- 1 Copy your `.cer` file to the `\temp\root` folder on the CN2.
- 2 Copy your `.der` and `.pvk` files to the `\temp\user` folder on the CN2.

Chapter 3 — Adding the CN2 to the Network

- 3 Tap **Start > Intermec Settings > Communications > 802.11 Radio > Security Settings > Certificates.**
- 4 Select **Import Root Certificates** and tap **Run App** to load the .cer file. A dialog box appears asking if you want to add the certificate to the root store.

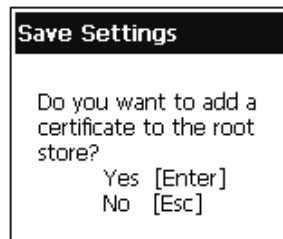

- 5 Tap **Enter** to add the certificate. A message box appears telling you that the root certificate has been imported.



- 6 Tap **OK** to close the Success message box.
- 7 Select **Import User Certificate** to load the .der and .pvk files. A message box appears telling you that the certificate has been imported.



- 8 Tap **OK** to close the Success message box.
- 9 Configure your CN2 for WPA or 802.1x security.

Disabling Security

If you choose not to use security with your wireless network, you can disable it on the CN2. Intermec recommends that you always set security in your network.

To disable security

- 1 Open Intermec Settings.
- 2 Tap **Communications** > **802.11 Radio** > **Security Settings** > **Microsoft Security**.
- 3 For **Network Authentication**, choose **Open**.
- 4 For **Data Encryption**, choose **Disabled**.
- 5 Tap **Save**.
- 6 Exit Intermec Settings.

Using the Modem Dock for Internet Access and E-mail

If you have purchased the optional CN2 Modem Dock (P/N 075499), you can configure the CN2 to use the modem dock to connect to the Internet and to access e-mail.

If your Internet Service Provider (ISP) is providing your e-mail service, follow the steps in the next section, “Connecting to the Internet Through the Modem Dock,” before you follow the steps in “Setting Up an E-mail Account Through the Modem Dock” on page 69.

For details about installing and using the modem dock, see the *CN2 Modem Dock Quick Start Guide* (P/N 075481) which ships with the modem dock.

Connecting to the Internet Through the Modem Dock

You can connect to the Internet through the modem dock.

To configure a connection to your Internet service provider

- 1 Install the modem dock, as described in the *CN2 Modem Dock Quick Start Guide*.

Chapter 3 — Adding the CN2 to the Network

- 2 Contact your ISP and obtain the following information:
 - ISP dial-up access phone number
 - User name
 - Password
- 3 Tap **Start > Settings > Network and Dial-up Connections**.



- 4 Double-tap **Make New Connection**.
- 5 In the **Type a name for the connection** field, enter a name for the connection, such as My ISP Connection.



Chapter 3 — Adding the CN2 to the Network

- 6 From the **Select the connection type** list, select **Dial-Up Connection** from the list of connection types.
- 7 Tap **Next**. The Modem screen appears.
- 8 From the **Select a modem** drop-down menu, choose **Hayes Compatible on COM1**.



- 9 Tap **Configure**. The Device Properties screen appears.

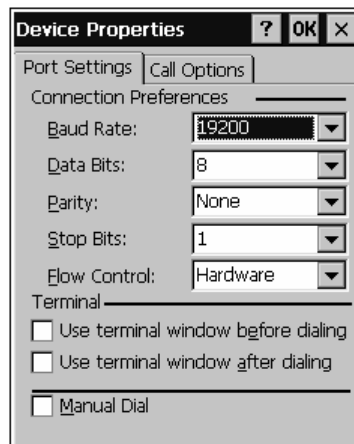

Connection Preferences: The connection preferences (such as **Baud Rate**) specify how the CN2 communicates with the modem dock.

- 10 Set the **Baud Rate** to 115200 bps.

- 11 (Optional) Tap the **Call Options** tab and make changes if necessary.

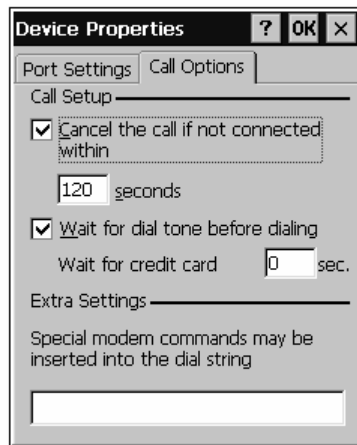

- 12 Tap **OK** at the top of the screen to return to the Modem screen.
- 13 If you changed the baud rate in Step 10, a message box appears. Tap **OK** to close the message box.

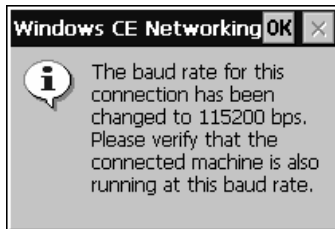

- 14 Tap **TCP/IP Settings** only if your ISP does not use a dynamically assigned IP address. When you are done making selections, tap **OK** at the top of the screen to return to the Modem screen.
- 15 Tap **Security Settings** to configure advanced security settings, if necessary. When you are done making selections, tap **OK** at the top of the screen to return to the Modem screen.

Chapter 3 — Adding the CN2 to the Network



- 16 Tap **Next**.
- 17 Fill in the **Country/region code** field, the **Area code** field, and the **Phone Number** field with the information provided by your ISP.

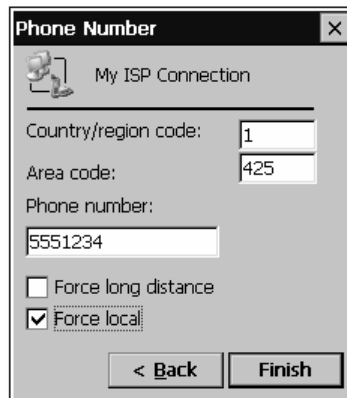

Note: When you connect to the Internet for the first time, you can specify the exact numbers that the modem dials. For help, see the next procedure, “To connect to the Internet for the first time.”

- 18 Check **Force long distance** if the modem needs to dial the country/region code, the area code, and the phone number. Or check **Force local** if the modem needs to dial only the phone number.

Chapter 3 — Adding the CN2 to the Network

- 19 Tap **Finish**.
- 20 Perform the steps in the next procedure, “To connect to the Internet for the first time.”

To connect to the Internet for the first time

- 1 Tap **Start > Settings > Network and Dial-up Connections**.
- 2 Double-tap the icon for the connection you just configured. The Dial-Up Connection screen appears.



- 3 In the **User Name** field, enter the user name provided by your ISP.
- 4 In the **Password** field, enter the password provided by your ISP.
- 5 (Optional) Check the **Save password** check box if you do not want to enter the password every time you connect.
- 6 Tap **Dial Properties**. The Dialing Properties screen appears.

Chapter 3 — Adding the CN2 to the Network



- 7 By default, the CN2 assumes that you are dialing from work, on a phone system that requires you to enter a 9 before dialing. If you do not need to enter 9 before dialing, follow these steps:
 - a Choose **Home** from the **Location** drop-down list. The location setting has a dialing pattern that does not include a 9 before dialing.
 - b Make sure the **Area Code** and **Country/Region** are correct.
 - c (Optional) Tap **Edit**. The Edit Dialing Patterns screen appears. Make sure the dialing pattern is appropriate and tap **OK** to return to the Dialing Properties screen.
 - d Tap **OK** to return to the Dial-Up Connection screen.
- 8 Tap **Connect**. The modem dock connects to your ISP.

To connect to the Internet

- 1 Tap **Start > Settings > Network and Dial-up Connections**.
- 2 Double-tap the appropriate connection icon. The Dial-Up Connection screen appears.
- 3 Your user name automatically appears in the **User Name** field. Your password automatically appears in the **Password** field if you checked the **Save password** check box.
- 4 Tap **Connect**. The modem dock connects to your ISP.

- 5 Tap **Hide** to minimize the Connected to *Name* screen, where *Name* is the name you configured for the connection.

To disconnect from the Internet

- Double-tap the **Connectivity** icon in the taskbar and then tap **Disconnect**.

Setting Up an E-mail Account Through the Modem Dock

You can send and receive e-mail messages using the modem dock and the Inbox application on your CN2. You need to set up a connection to an e-mail server.



Note: The ISP or network must use a POP3 or IMAP4 e-mail server and an SMTP gateway.

You can use multiple e-mail services to receive your messages. For each e-mail service you intend to use, first set up and name the e-mail service. If you use the same service to connect to different mailboxes, set up and name each mailbox connection.

To configure your e-mail account

- 1 Contact your ISP and obtain the following information:
 - POP3 or IMAP4 host name
 - SMTP host name
 - User name
 - Password
- 2 Tap **Start > Programs > Inbox** to open the Inbox application.

Chapter 3 — Adding the CN2 to the Network

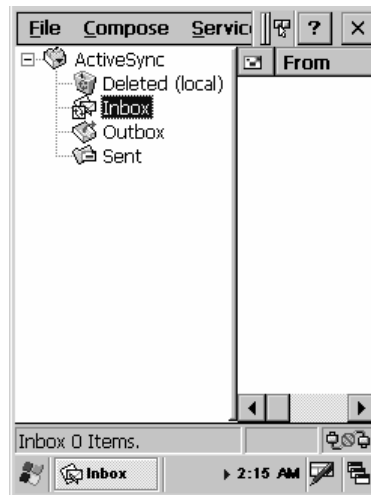



- 3 Tap **Service** > **Options**. The Options screen appears.
- 4 Drag the screen to the left to view the right side of the screen.
- 5 Tap **Add**. The Service name screen appears.
- 6 Select the appropriate service type from the **Service Type** drop-down menu, either **POP3** or **IMAP4**.
- 7 (Optional) Enter a meaningful name in the **Service Name** field. If you are setting up multiple e-mail services, each needs a unique name.
- 8 Tap **OK**.
- 9 In the **Connection** drop-down list, choose the appropriate connection. If you configured a connection to your ISP as described in the previous section, that connection appears in the list. You may want to choose that connection.
- 10 In the **POP3 Host** or **IMAP4 Host** field, enter the host name provided by your ISP.
- 11 In the **User ID** field, enter the user name provided by your ISP.
- 12 In the **Password** field, enter the password provided by your ISP.
- 13 If you do not want to type the password each time you connect, check the **Save Password** check box.

Chapter 3 — Adding the CN2 to the Network

- 14 Drag the screen to the left to view the right side of the screen.
- 15 If you want to be able to send e-mail from the CN2, in the **SMTP host for sending email** field, you must enter the SMTP host name provided by your ISP.



Note: The SMTP host name may be the same as your POP3 host name or IMAP4 host name.

- 16 (Optional) For help determining if you need to set the optional parameters like **Domain**, tap  to view the Inbox online help.
- 17 Tap **Next**. The POP3 Mail General Preferences screen appears.
- 18 Check or uncheck the check boxes to set your connection preferences. For help, tap  to view the Inbox online help.
- 19 Tap **Next**. The POP3 Mail Inbox Preferences screen appears.
- 20 By default, Inbox downloads only the message headers. If you want to download the entire e-mail message, select **Get full copy of message**.
- 21 Drag the screen to the left to view the right side of the screen.
- 22 (Optional) If you want to download attachments and meeting requests, check the appropriate check boxes.
- 23 Tap **Finish**.
- 24 (Optional) Tap the **Compose**, **Read**, **Delete**, and **Storage** tabs to further customize Inbox.
- 25 Tap **OK** to exit the **Options** screen.

To send and receive e-mail

- Tap **Start** > **Programs** > **Inbox**. For help, tap  to view the Inbox online help.

Chapter 3 — Adding the CN2 to the Network



4 Developing and Installing Applications

Use this chapter to understand how to develop and install applications for the CN2. In this chapter, you will find these sections:

- Developing Applications for the CN2
- Installing Applications on the CN2
- Launching Your Application Automatically

Developing Applications for the CN2

The CN2 runs applications programmed in Microsoft Embedded Visual C++. The CN2 can also run applications developed for the .NET Compact Framework using Microsoft C# and Visual Basic .NET.

Use this section to understand the hardware and software you need to perform these tasks:

- Developing a new application for the CN2
- Developing a web-based application for the CN2

Developing a New Application

Use the Intermec SDK to develop new applications to run on the CN2. The SDK is a library of C++ language functions you can use to create applications for the CN2.

The SDK is available as a download from the Intermec Developers Library, which is located on the Intermec web site at www.intermec.com/idl. From the Intermec Developers Library, you can download these items:

- Platform SDK for the CN2 Handheld Computer
- Additional Software Downloads or Resource Kits that you can use to develop applications

You need these hardware and software components to use the Intermec SDK:

- Pentium PC, 400 MHz or higher
- Windows 2000 (Service Pack 2 or later) or Windows XP (Home, Professional, or Server)
- For native C++ development, Microsoft eMbedded Visual C++ version 4.0 with eVC++ Service Pack 2
- For .NET Development and Compact Framework (C# and VB.NET), Microsoft Visual Studio .NET 2003
- 128MB RAM (196MB recommended)
- 360MB hard drive space for minimum installation (720MB for complete)

Chapter 4 — Developing and Installing Applications

- CD-ROM drive compatible with multimedia PC specification
- VGA or higher-resolution monitor (Super VGA recommended)
- Microsoft Mouse or compatible pointing device

Developing a Web-Based Application

You can develop web-based data collection applications for use on the CN2. For help, see any HTML source book. The CN2 contains Internet Explorer (IE) 6.0 for Windows CE for you to use. The Microsoft standard IE 6.0 is available from the desktop and provides all of the common elements you expect to find.

To open Microsoft Internet Explorer

- Double-tap **Internet Explorer** from the desktop. The Internet Explorer default window appears.

Installing Applications on the CN2

There are several ways you can install applications on the CN2:

- You can package your application as a cabinet (.cab) file.
- If you have a simple application, you may only need to deliver the .exe file.
- You can copy a directory structure that contains the application, supporting files, DLLs, images, and data files.

Intermec recommends using CAB files to install your applications. The CN2 uses standard Windows CE CAB files and will install third-party CAB files. After the CN2 executes a CAB file, it deletes the file. To keep your CAB files so that they can be installed when you perform a cold boot, you need to save them to the \DiskOnChip\Persistent Copy\CABFiles directory. On a cold boot, the CAB files are copied to the \CABFiles directory in the object store where they are executed and deleted. The original copy remains in the \DiskOnChip\Persistent Copy\CABFiles directory to be installed on the next cold boot.

Chapter 4 — Developing and Installing Applications

Intermec recommends that you store your applications in a folder specific to your application underneath the \PROGRAM FILES folder.

Intermec recommends that you store your application data in one of these folders on the CN2:

Folder	Description
SDMMC Disk	The SDMMC Disk folder shows the contents of the optional SD card. Intermec recommends that you place application install files in this folder.
DiskOnChip	The DiskOnChip folder is an area of storage that is part of the CN2 flash memory. This storage area is not deleted during a cold boot.

There are several ways you can install files and applications on the CN2:

- ActiveSync
- SD Card
- Wavelink Avalanche

The following sections explain how to use each one of these processes to install your application on the CN2.

Installing Applications Using ActiveSync

You can use ActiveSync to establish a connection between your PC and the CN2. ActiveSync allows you to transfer files, synchronize files, perform remote debugging, and other device management activities.



Note: ActiveSync is a free application available from the Microsoft web site.

To establish a partnership between your PC and the CN2, you need these items:

- USB interface cable (P/N 321-576-002)
- CN2 communications dock (P/N 225-696-001)
- ActiveSync version 3.7.1 or later

Installing ActiveSync and Establishing a Partnership

You can use a USB cable to establish your initial partnership between the CN2 and your PC.

To install ActiveSync and establish a partnership

- 1 Download ActiveSync from the Microsoft web site and follow the onscreen instructions for installing it on your PC. When the installation process is complete, the Get Connected dialog box appears.



- 2 Connect the CN2 to your PC with the CN2 communications dock and a USB cable.
- 3 Click **Next** in the Get Connected dialog box. ActiveSync detects a device on the USB port and prompts you to set up a new partnership.
- 4 In the Set Up a Partnership dialog box, click **Next**.
- 5 In the Select Number of Partnerships dialog box, select **Yes, I want to synchronize with only this computer**, and then click **Next**.
- 6 In the Select Synchronization Settings dialog box, check the items you want to synchronize and click **Next**.
- 7 In the Setup Complete dialog box, click **Finish**.

Chapter 4 — Developing and Installing Applications

When the partnership has been established, the following screen appears on your PC showing the device name of your CN2 and the Connected status.

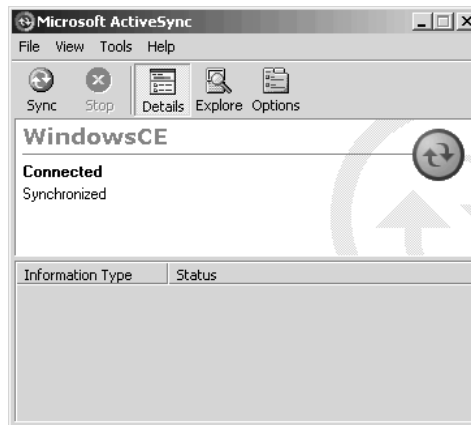

The Microsoft ActiveSync Screen

An ActiveSync icon (↻) also appears on the CN2 status bar indicating that it has established an ActiveSync partnership with your PC.



Note: If ActiveSync does not establish a partnership on the first try, the Get Connected dialog box appears on your PC with the message “Your device was not detected.” Make sure all of your cables are securely connected and click **Next** on the Get Connected dialog box until your device is detected. You may need to remove the CN2 from the communications dock, and then insert it back into the communications dock to establish a partnership.

After the partnership is established, ActiveSync initiates all future connections. To connect to your PC using ActiveSync in the future, simply place a CN2 in the communications dock and turn on the CN2.

Using ActiveSync to Copy Files and Install Applications

You can use ActiveSync to copy files to the CN2 and to install applications. Use the following procedures to learn how to copy files and install applications on the CN2 using ActiveSync.

Chapter 4 — Developing and Installing Applications

To install an application on the CN2 using ActiveSync

- 1 Connect the CN2 to your PC using ActiveSync. For help, see the previous section, “Installing ActiveSync and Establishing a Partnership.”
- 2 On the Microsoft ActiveSync screen, click **Explore**. Windows Explorer opens the Mobile Device window of your CN2.
- 3 In Windows Explorer on your PC, browse to the file that you want to copy to your CN2.



- 4 Right-click the file and click **Copy**.
- 5 Place the cursor in the SDMMC Disk or DiskOnChip folder of your CN2, right-click, and click **Paste**.
- 6 The file is copied to the CN2 and you can see it using **My Computer** on the CN2.
- 7 Navigate to your application file and run it.

After your application is installed, you can run it from the Program files folder from My Computer.

Installing Applications Using the Optional SD Card

Using your SD card is the best method for you to install applications. For help inserting and removing the SD card, see “Using the Optional SD Card” on page 22.

To install applications using the SD card

- 1 If you are using an SD card reader, remove the SD card from the CN2 and place it in the reader.
- 2 Copy your application file to the SD card.
If you are using ActiveSync or Wavelink Avalanche to copy the files to the SD card, place the application in the SDMMC Disk folder located in My Computer.
- 3 If you are using an SD card reader, insert the SD card back into the CN2.
- 4 Navigate to the SDMMC Disk folder and run your application.

After your application is installed, you can run it from the Program files folder from My Computer.

Installing Applications Using Wavelink Avalanche

You can use the Wavelink Avalanche device management system to install applications on all of your wireless CN2s.

The wireless CN2 ships with the Avalanche Enabler already loaded on it. The Avalanche Enabler is configured to activate automatically (typically on a warm boot).



Note: If you manually activate the Avalanche Enabler on the CN2, you may be prompted for a password when you exit the Avalanche Enabler. The default password is `leave`.

Each time the Avalanche Enabler is activated, the CN2 attempts to connect to the Avalanche Agent. When the CN2 connects to the Agent, the Agent determines whether an update is available and immediately starts the software upgrade, file transfer, or configuration update.

Chapter 4 — Developing and Installing Applications

To use Avalanche to remotely manage the CN2

- 1** Install software packages and updates for the CN2 using the Avalanche Management Console. For help using the console, see the online help.
- 2** Schedule the CN2 updates or manually initiate an update using the Avalanche Management Console.

For more information on using Wavelink Avalanche, contact your local Intermec representative or visit the Wavelink web site at www.wavelink.com.

Launching Your Application Automatically

To launch your application automatically on the CN2 every time you perform a warm or cold boot, make sure your CAB file places a shortcut to your application in the \Windows\StartUp folder.

Chapter 4 — Developing and Installing Applications



5 Troubleshooting and Maintaining the CN2

Use this chapter to solve problems you may encounter while using the CN2. You will also find information on booting the computer, upgrading the CN2, and performing routine maintenance. In this chapter you will find these sections:

- Problems and Solutions
- Running Diagnostics
- Sending the CN2 to Intermec for Service
- Booting the CN2
- Upgrading the CN2
- Cleaning the Scanner Window and the Touch Screen

Problems and Solutions

These tables offer solutions to the problems you may encounter.

Problems While Operating the CN2

Problem	Solution
You press the Power key to turn on the CN2 and nothing happens.	Try these possible solutions in order: <ul style="list-style-type: none">• Make sure the battery door is installed correctly and completely closed.• Make sure you have a charged battery installed correctly. For help, see “Installing and Charging the Battery” on page 6.• The battery may be discharged. Replace the battery with a spare charged battery, or charge the battery and try again.• Warm boot the CN2. For help, see “Warm Booting the CN2” on page 94.
You press the Power key to turn off the CN2 and nothing happens.	To turn off (or suspend) the CN2, you need to hold the Power key for 2 to 3 seconds and then release it. If the CN2 is processing data, it may not turn off when you press the Power key. Wait until the CN2 finishes processing. If the CN2 appears to be locked up, warm boot the CN2. For help, see “Warm Booting the CN2” on page 94. If the CN2 does not respond to a warm boot, see “Cold Booting the CN2” on page 95.
The CN2 screen is not responding to the stylus.	Try these possible solutions in order: <ul style="list-style-type: none">• Recalibrate the screen. For help, see “Calibrating the Screen” on page 17.• Press and hold the Power key for 2 to 3 seconds, and then release it to turn off the CN2. Press the Power key again to turn on the CN2.

Chapter 5 — Troubleshooting and Maintaining the CN2

Problems While Operating the CN2 (continued)





Problem	Solution
You place the CN2 in the communications dock, and the Battery light turns on and is orange.	<ul style="list-style-type: none"> • The temperature may not be within the charging range. Make sure that the temperature is from 0°C to 45°C (32°F to 113°F). • The battery may be damaged. Replace the battery.
The CN2 appears to be locked up and you cannot enter data.	<p>Try these possible solutions in order:</p> <ul style="list-style-type: none"> • Wait at least 10 seconds and try again. If the CN2 is still connecting to the Intermec Application Server or the host, it ignores any input from the keypad or scanner. • Press and hold the Power key for 2 to 3 seconds, and then release it to turn off the CN2. Press the Power key again to turn on the CN2. • Warm boot the CN2. For help, see “Warm Booting the CN2” on page 94. • Cold boot the CN2. For help, see “Cold Booting the CN2” on page 95. • Try reloading the firmware. For help, see “Upgrading the CN2” on page 96. • If the CN2 will not boot or reset, contact your local Intermec service representative for help.
Nothing happens when you type on the USB keyboard attached to the CN2 modem dock.	<p>Try these possible solutions in order:</p> <ul style="list-style-type: none"> • Make sure the USB keyboard is either a Dell Model SK-8115 or a Logitech Model Y-BF37. • Make sure all cables are securely connected, the CN2 is firmly seated in the dock, and you are running an application that accepts keyboard input. • If the modem dock is attached to an AC power source, make sure the USB Host Power parameter is set to On When Powered. If the modem dock is not attached to an AC power source, make sure the USB Host Power parameter is set to Always On. For help, see “Using the Optional USB Keyboard” on page 25. • Warm boot the CN2 and place it in the dock. For help, see “Warm Booting the CN2” on page 94.

Chapter 5 — Troubleshooting and Maintaining the CN2

Problems While Operating the CN2 (continued)

Problem	Solution
The CN2 exhibits unexpected behavior after you install or remove an application.	<p>You may need to reset the registry and clear the object store. Follow these steps:</p> <ol style="list-style-type: none">1 Tap Start > Control Panel.2 Double-tap the Utilities icon. The Settings window appears.3 Tap the Registry Reset tab.4 Tap the Reset Registry button.5 Tap Yes when the Confirm message appears.6 When the screen goes blank, immediately remove the battery and cold boot the CN2. For help, see “Cold Booting the CN2” on page 95. <p> Note: You can also use this procedure to return the CN2 to its default software configuration.</p>

Problems While Configuring Security



Problem	Solution
The CN2 does not appear to be authenticating and a Network Connection icon (   or ) does not appear on the status bar.	<p>The CN2 may not be communicating with your access point. Make sure the network name on the CN2 is the same as the network name (SSID) of the access point that you are trying to communicate with. The default network name is “INTERMEC.”</p> <p>The 802.1x security network may not be active. Make sure that the server software is properly loaded and configured on the server PC. For help, see the documentation that shipped with your server software.</p>
A Network Connection icon (shown above) appears in the status bar, but it disappears.	The CN2 may not be communicating with the access point that you want it to communicate with. Make sure that the network name on the CN2 is the same as the network name of the access point that you are trying to communicate with. The default network name is “INTERMEC.”

Problems While Configuring Security (continued)

Problem	Solution
A Network Connection icon appears in the status bar, but it disappears (<i>continued</i>).	The access point that you are trying to communicate with may not be communicating with the server. Make sure your access point is turned on, properly configured, and has 802.1x security enabled.
The CN2 indicates that it is not authenticated.	<p>Make sure that:</p> <ul style="list-style-type: none"> • The User Name and Password parameters on your CN2 match the user name and password on your authentication server. You may need to re-enter the password on both your CN2 and the authentication server. • On your authentication server, the user and group are allowed and the group policy is allowed to log in to the server. For help, see the documentation for your authentication server software. • The IP address and secret key for your access point must match the IP address and secret key on your authentication server. You may need to re-enter the IP address and secret key on both your access point and authentication server. • The authentication server software is running on the server PC.
The CN2 indicates that it is authenticated, but it does not communicate with the host.	Make sure that the CN2 IP address, host IP address, subnet mask, and default router are properly configured for your network.
You receive a message saying, “The server certificate has expired or your system date is incorrect” after you cold boot the CN2.	The date and time on the CN2 are not saved through a cold boot. You need to re-enter the date and time and then save your changes. For help, see Step 4 on page 96.
You are setting up multiple access points in a network, with different SSIDs, and the connection fails.	The CN2 does not save WEP key values when you change the SSID. Re-enter the WEP key value after you change the SSID and save your changes. You should now be able to connect to the different access points.

Chapter 5 — Troubleshooting and Maintaining the CN2

Problems With Wireless Connectivity

Problem	Solution
A Network Connection icon ( or ) appears on the status bar, but the host computer is not receiving any data from the CN2.	<p>In a UDP Plus network, there may be a problem with the connection between the Intermec Application Server and the host computer. Check with your network administrator or see the user's manual for the Intermec Application Server.</p> <p>In a TCP/IP network, there may be a problem with the connection between the access point and the host computer. Check with your network administrator or use your access point user's manual.</p>
When you turn on the CN2 after it was suspended for a while (10-15 minutes or longer), it can no longer send or receive messages over the network.	<p>The CN2 may not be recognizing the network card. Turn off the CN2, and then turn it on again.</p> <p>The host may have deactivated or lost your current terminal emulation session. In a TCP/IP direct connect network, you need to turn off the "Keep Alive" message (if possible) from the host so that the TCP session is maintained while a CN2 is suspended.</p>
The CN2 is connected to the Intermec Application Server or host computer and you move to a new site to collect data. A Network Connection icon was visible but now the no network connection icon () is visible.	<p>You may have gone out of range of an access point.</p> <p>Try moving closer to an access point or to a different location to re-establish communications. Once you are in range again, the network connection icon appears again. Any data you collected while out of range is transmitted over the network.</p>

Problems With Wireless Connectivity (continued)

Problem	Solution
The no network connection icon () appears on the status bar.	<p>The no network connection icon appears in three situations:</p> <ul style="list-style-type: none">• The CN2 may not have an IP address. You must configure an IP address for the CN2 or make sure that DHCP assigned an address. Use Intermec Settings and select the radio tab to make sure an IP address has been assigned. For help, see “Configuring the CN2 Locally With Intermec Settings” on page 32.• The CN2 may not be connected to the access point. Try these possible solutions in order:<ul style="list-style-type: none">• Make sure the access point is turned on and operating.• Make sure you are not using the CN2 out of range of an access point. Try moving closer to an access point to re-establish communications.• Make sure the CN2 is configured correctly for your network. The radio parameters on the CN2 must match the values set for all access points the CN2 may communicate with. For help, see “Configuring 802.11b/g Radio Communications” on page 39.• If you have an 802.11b/g radio, the radio initialization process may have failed. Try resetting the CN2. For help, see “Booting the CN2” on page 94.• If you have tried these possible solutions and the no network connection icon still appears, you may have a defective radio card. For help, contact your local Intermec service representative.

Problems While Scanning Bar Codes

Problem	Solution
You cannot see a red beam of light from the scanner when you press the Scan button or one of the Side Scan buttons and aim the scanner at a bar code label.	There are three possible problems: <ul style="list-style-type: none">• You may be too far away from the bar code label. Try moving closer to the bar code label and scan it again.• You may be scanning the bar code label “straight on.” Change the scanning angle and try again.• The PSM files may not be correctly installed. For help, see “Upgrading the Persistent Storage Manager Files” on page 97. You can test the effective range of the scanner. Move within 61 cm (2 ft) of a wall and test the scanner. You need to be within the scanning range to scan bar code labels. For help scanning bar codes, see “Scanning Bar Codes” on page 21.
When you release the Scan button or Side Scan button, the Good Read light does not turn off.	The Good Read light will remain on if you configure the CN2 to use continuous/edge triggering. If you configure the CN2 for level triggering and the Good Read light remains on, there may be a problem. Press the Scan button or one of the Side Scan buttons again without scanning a bar code label. If the light is still on, contact your local Intermec service representative.
The scanner will not read the bar code label.	Make sure you aim the scanner beam so it crosses the entire bar code label in one pass. The angle you are scanning the bar code label may not be working well, or you may be scanning the label “straight on.” Try scanning the bar code label again, but vary the scanning angle. The bar code label print quality may be poor or unreadable. To check the quality of the bar code label, try scanning a bar code label that you know will scan. Compare the two bar code labels to see if the bar code quality is too low. You may need to replace the label that you cannot scan.

Problems While Scanning Bar Codes (continued)

Problem	Solution
<p>The scanner will not read the bar code label (<i>continued</i>).</p>	<p>Make sure the bar code symbology you are scanning is enabled. Use Intermec Settings to check the symbologies. If your bar code symbology is disabled, enable it and then try scanning the bar code label again.</p> <p> Note: If you restored the CN2 to factory default settings, some of the symbologies may have been disabled.</p> <p>Make sure that the application you are running on the computer is expecting input from a bar code. You may need to use the input panel to enter this information instead of scanning it.</p>
<p>The scanner does not read the bar code labels quickly, or the scanning beam seems to be faint or obscured.</p>	<p>The scanner window may be dirty. Clean the window with a solution of ammonia and water. Wipe dry. Do not allow abrasive material to touch the window.</p>
<p>You scan a valid bar code label to enter data for your application. The data decoded by the CN2 does not match the data encoded in the bar code label.</p>	<p>The computer may have decoded the bar code label in a symbology other than the label's actual symbology. Try scanning the bar code label again. Make sure you scan the entire label.</p> <p>To operate the computer quickly and efficiently, you should only enable the bar code symbologies that you are going to scan.</p>

Running Diagnostics

You can run Intermec Diagnostics to determine if there are any problems with your CN2. You can run Intermec Diagnostics at any time, even while running an application.

To run Intermec Diagnostics

- 1 Tap **Start** > **Settings** > **Control Panel**.
- 2 Double-tap the **Intermec Diagnostics** icon.



Intermec
Diagnostics

- 3 From the **Select test** drop-down list, choose which diagnostic tests to run:
 - You can tap the test.
 - You can type the number of the test on the numeric keypad or the USB keyboard.

For help deciding which tests to run, see the following table, “Summary of Intermec Diagnostics Tests.”

- 4 When you have finished running tests, press **ESC** to exit.



Note: If a test contains multiple test actions, you cannot press **ESC** to exit until you have completed all the test actions.

Summary of Intermec Diagnostic Tests

Test Name	Description	Tips
1. Backlight Test	Verifies that the backlight is working properly by turning it off, on, and testing each dim level.	When you start the Backlight Power Control test, the backlight turns off. Tap near the top of the screen to turn the backlight on again so you can indicate if the test passed or failed.

Chapter 5 — Troubleshooting and Maintaining the CN2

Summary of Intermec Diagnostic Tests (continued)

Test Name	Description	Tips
2. Battery Information	Displays the charge levels for the main battery and the backup battery. Also indicates if AC power is detected.	Tap X to exit the test.
3. Display Test	Verifies that every pixel on the CN2 screen is working properly.	When each test action begins, a message explains what you should see on this test display. Press Enter to dismiss the message, and then press Enter again when you finish examining the test display.
4. Hardware Configuration	Reads, verifies, and displays information about hardware configuration. Also displays the version of the operating system running on your CN2.	You may be asked to provide this information if you contact Intermec Product Support.
5. Memory Information	Displays information about the RAM, which is divided into program memory and storage memory.	Tap X to exit the test.
6. Networking Test	Displays your IP address and validates your network connection.	Tap X to exit the test.
7. Audio Test	Verifies that the audio sounds are working correctly.	Tap X to exit the test.
8. Touch Screen Test	Verifies that the touch screen is working correctly.	When the test begins, a message directs you to draw on the screen with the stylus. Tap X to dismiss the message, and a white screen appears for you to draw on. When you finish drawing, press any key to exit.

Sending the CN2 to Intermec for Service

If you send the CN2 in for service, it is your responsibility to save the computer data and configuration. Intermec is responsible only for ensuring that the keypad and other hardware features match the original configuration when repairing or replacing your computer.

For help understanding your warranty and finding help, see “Global Service and Support” on page viii.

You may be asked for the version of the operating system running on your CN2. For help finding this information, see the Hardware Configuration test in the previous section, “Running Diagnostics.”

Booting the CN2

You seldom need to warm or cold boot the CN2. The CN2 uses the configuration currently saved in flash memory during the boot process.

You need to boot the CN2 when an application is locked up and will not respond, when you upgrade the firmware, or when you reflash the computer. The next instructions explain how you warm and cold boot the CN2.

Warm Booting the CN2

If your charged CN2 does not resume after pressing the **Power** key, or if the computer or an application is locked up, you may need to warm boot it.

The following procedures explain the two ways to warm boot the CN2:

- Using the Warm Boot button
- Using the Power key

To warm boot the CN2 using the Warm Boot button

- Using the end of the stylus, press the **Warm Boot** button inside of the stylus holder.

Chapter 5 — Troubleshooting and Maintaining the CN2

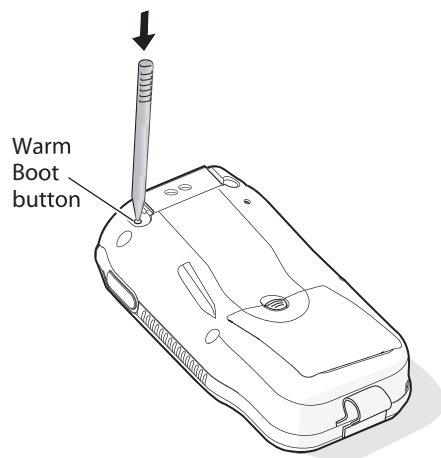

The screen goes blank immediately. The screen remains blank for a few seconds, the Refreshing the File System dialog box appears, and the CN2 warm boots.

To warm boot the CN2 using the Power key

- 1 Press and hold the **Power** key for approximately 10 seconds.



Note: After about 5 seconds, the backlight toggles. Keep holding the **Power** key for another 5 seconds until the backlight flashes.

- 2 Release the **Power** key. The screen remains blank for a few seconds, the Refreshing the File System dialog box appears, and the CN2 warm boots.

Cold Booting the CN2

If the CN2 or application is locked up and does not respond to a warm boot, follow this procedure to perform a cold boot. When you perform a cold boot, all data in your RAM storage is deleted.

To cold boot the CN2

- 1 Open the battery door and remove the battery. For help, see “Removing the Battery” on page 8.

Chapter 5 — Troubleshooting and Maintaining the CN2

- Using the end of the stylus, press the **Reset** button on the inside of the battery compartment.

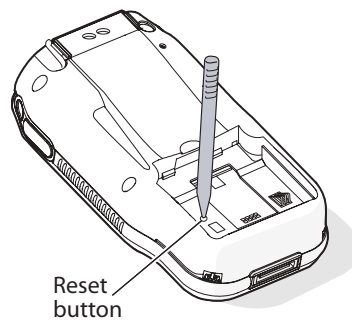

Do not use force or a sharp object when pressing the Reset button. You may damage the Reset button.

Attention: N'employez pas la force ou un objet pointu quand appuyant sur le remettez à zéro le bouton. Vous pouvez endommager le remettez à zéro le bouton.

- Install the battery and battery door. After approximately 4 seconds, the CN2 starts the power on sequence.
- The date and time settings are not saved through a cold boot. You need to reset the time and date:
 - Tap **Start** > **Settings** > **Control Panel**.
 - Double-tap the **Date/Time** icon.
 - Set the date and time.
 - Tap **OK** to save the new time and date.
 - Tap **X** to exit Date/Time.
 - Tap **X** to exit Control Panel.

Upgrading the CN2

When you upgrade your CN2, you are updating these two components:

- Operating system (OS)
- Persistent Storage Manager (PSM) files

Upgrading the Operating System

When you upgrade the operating system, you erase the current configuration and replace it with the new default configuration. You will need to set the network communications parameters on the CN2 to reestablish communications with the other devices in the wireless network.

To upgrade the OS, you need:

- an SD card formatted as FAT16.



Note: The CN2 currently supports SanDisk SD cards only. Intermec cannot guarantee that other SD cards will work with the CN2.

- an SD card reader.
- the latest upgrade ZIP file. This file is available from the Intermec web site at www.intermec.com. Go to **Service & Support > Downloads**. Make sure the file you select is for your language and that it has an SD at the end of the file name.

To upgrade the operating system

- 1 Download the latest upgrade ZIP file from the Intermec web site to your desktop PC.
- 2 Unzip the files on your desktop PC.
- 3 Place the SD card in the SD card reader.
- 4 Copy the nk.bin and eboot.bin files to your SD card. Place the files in the SDMMC Disk folder.
- 5 Open the battery door and remove the battery. For help, see “Removing the Battery” on page 8.
- 6 Insert the SD card into the CN2. For help, see “Using the Optional SD Card” on page 22.
- 7 Using the end of the stylus, press the **Reset** button on the inside of the battery compartment.

Chapter 5 — Troubleshooting and Maintaining the CN2

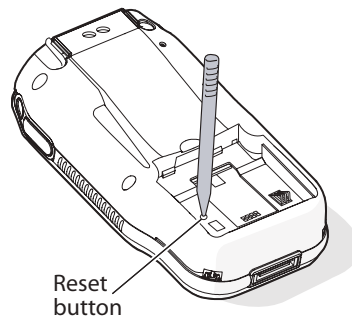

Caution

Do not use force or a sharp object when pressing the Reset button. You may damage the Reset button.

Attention: N'employez pas la force ou un objet pointu pour appuyer sur le bouton de remise. Vous pouvez endommager le bouton de remise.

- 8 Hold down a key while you install the battery:
 - On the numeric keypad, hold down the **8** key while you install the battery. Do not release the **8** until the CN2 Bootloader Menu appears.
 - On the scroll keypad, hold down the **▼** key while you install the battery. Do not release the **▼** until the CN2 Bootloader Menu appears.
- 9 Install the battery door and place the CN2 in a communications dock.
- 10 Select **Update OS + Bootloader** from the menu:
 - On the numeric keypad, use the **8** key as a down arrow and the **2** key as an up arrow to select **Update OS + Bootloader**. Then press **Enter**.



Note: The **8** and **2** keys on the numeric keypad will function as arrow keys only until the OS loads.

- On the scroll keypad, use the **▼** and **▲** keys to select **Update OS + Bootloader**. Then press **Enter**.

Messages about the download status appear at the bottom of the screen.

Chapter 5 — Troubleshooting and Maintaining the CN2

- 11 The “Need Reboot” message appears and **Cold Boot** is selected.
- 12 Press **Enter**. The CN2 cold boots and the Refreshing File System status box appears.
- 13 If the Confirm File Replace dialog box appears, tap **Yes To All**. The CN2 finished rebooting, and your operating system is updated.

Upgrading the Persistent Storage Manager Files

To upgrade the Persistent Storage Manager (PSM) files for your CN2, you need:

- the device upgrade ZIP file containing the PSM files. This file is available from the Intermec web site at www.intermec.com. Go to **Service & Support > Downloads**.
- an SD card reader.

To upgrade the PSM files

- 1 Copy the device upgrade ZIP file to your PC, and unzip the PSM files. You should see these folders:
 - 2577
 - DOCIImage
- 2 Remove the SD card from the CN2 and place it in the SD card reader. For help, see “Using the Optional SD Card” on page 22.
- 3 Copy the 2577 and DOCIImage folders to the SD card.
- 4 Install the SD card in your CN2.
- 5 Cold boot your CN2. For help, see “Cold Booting the CN2” on page 95. A dialog box appears telling you that it is updating the PSM. When this process is complete, the CN2 cold boots again and installs the files.

After the CN2 cold boots, the Refreshing the File System dialog box appears. Your CN2 is loaded with the new PSM files.

- 6 Remove the SD card.

Cleaning the Scanner Window and the Touch Screen

To keep the computer in good working order, you may need to clean the scanner window and touch screen.

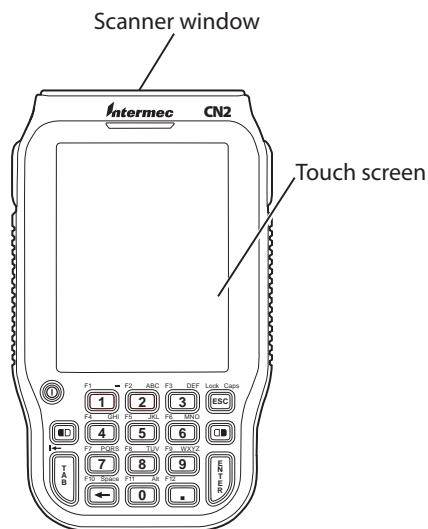

Cleaning the CN2: You can clean the scanner window and touch screen.

Clean the scanner window and the touch screen as often as needed for the environment in which you are using the computer. Use a solution of ammonia and water.



Caution

There are no user-serviceable parts inside the CN2. Opening the unit will void the warranty and may cause damage to the internal components.

Attention: Le CN2 ne contient pas de pièces réparables par l'utilisateur. Le fait d'ouvrir l'unité annule la garantie et peut endommager les pièces internes.

To clean the scanner window and touch screen

- 1 Press and hold the **Power** key for 2 to 3 seconds, and then release it to turn off the CN2.

Chapter 5 — Troubleshooting and Maintaining the CN2

- 2** Dip a clean towel or rag in the ammonia solution and wring out the excess. Wipe off the scanner window and touch screen. Do not allow any abrasive material to touch these surfaces.
- 3** Wipe dry.

Chapter 5 — Troubleshooting and Maintaining the CN2



A Specifications and Accessories

Physical and Environmental Specifications

Use this section to find technical information about the CN2 and its available features and options.

Physical Dimensions

Length: 14.7 cm (5.8 in)

Width: 8.6 cm (3.4 in)

Thickness: 3.5 cm (1.4 in)

Weight: 370 g (11.9 oz)

Power and Electrical Specifications

Operating: Rechargeable 2150 mAh lithium-ion battery

Backup: Rechargeable NiMH 20 mAh battery

Electrical rating: \approx 3.7 V; 1.5 A peak

Temperature and Humidity Specifications

Operating: 0°C to 50°C (32°F to 122°F)

Storage: -10°C to 50°C (14°F to 122°F)

Charging: 0°C to 45°C (32°F to 113°F)

Humidity: 5% to 95% relative humidity, non-condensing

Environmental rating: IP64

Screen Specifications

- RGB 240 x 320 pixels
- 8.9 cm (3.52 in) diagonal square active area, ¼ VGA

Keypads

- 18-key numeric keypad
- 10-key scroll keypad

Appendix A — Specifications and Accessories

Bar Code Symbologies

- Codabar
- Code 39
- Code 128
- Interleaved 2 of 5
- UPC/EAN
- MSI

1D Linear Imager Reading Distances

This table contains reading distance on the 1D line.

Symbology	Density (mm)	Density (mil)	Min (mm)	Max (mm)	Min (inch)	Max (inch)
Code 39	0.1	4	95	136	3.7	5.4
	0.3	12	45	240	1.8	9.4
	0.5	20	44	300	1.7	11.8
	1	39	120	400	4.7	15.7
EAN	0,33 mm/ 100% contrast	13 mils/ 100% contrast	45	240	1.8	9.4
	0,33 mm/ 25% contrast	13 mils/ 25% contrast	61	157	2.4	6.2

Accessories for the CN2

You can use these accessories (sold and ordered separately) with the CN2. To order accessories, contact your local Intermec sales representative.

CN2 Battery (P/N 074201)

Use the lithium-ion battery to provide main power to the computer.

CN2 Communications Dock (P/N 225-696-001)

Use the communications dock to charge your battery, to provide power to your CN2, and to communicate through a USB connection.

Appendix A — Specifications and Accessories

CN2 Modem Dock (P/N 075499)

Use the modem dock to communicate through a modem connection, to communicate through a USB connection, to charge your battery, to provide power to the CN2, and to attach a USB keyboard to the CN2.

AC Power Supply (P/N 074246)

Use this AC power supply to provide power to the CN2 and charges its battery when it is in the CN2 communications dock or CN2 modem dock.



You must use only the Intermec power supply approved for use with the CN2. Using any other power supply will damage the CN2.

Attention: Vous devez utiliser seulement le bloc d'alimentation Intermec désigné pour le CN2. L'utilisation d'autre blocs d'alimentation endommagera le CN2.

USB Type B Interface Cable (P/N 321-576-002)

Use the USB Type B interface cable with the communications dock and modem dock to transfer data and applications through a USB connection.

CN2 Handstrap (P/N 075400)

Use the handstrap for a comfortable way to hold the CN2 for extended periods of time.

CN2 Holster (P/N 074490)

Use the holster for a convenient way to carry the CN2 when you are not using it.

CN2 Dust Cover (P/N 074103)

Use the dust cover to protect the CN2 keypad in dusty environments.

CN2 Serial Adapter (P/N 074247)

Use the serial adapter to turn the 16-pin serial port on the CN2 into a DB9 (9-pin) male serial connector that you can connect to a serial printer.



B Default Configuration

Default Configuration

Use the following tables to see the default configuration settings of the CN2. If you restore the CN2 to factory default settings, it will use these values. The tables are organized according to the options in Intermec Settings.

Default Scanner Configuration

Symbology	Default Value
Codabar	Disabled
Code 39	Enabled
Code 128	Enabled
Interleaved 2 of 5	Disabled
MSI	Enabled
UPC/EAN	Enabled

Symbology Options	Default Value
Preamble	No characters (disabled)
Postamble	No characters (disabled)
Global Symbology ID	Disable

Virtual Wedge Settings	Default Value
Virtual Wedge Enable	Enable
Grid	Null

Appendix B — Default Configuration

Default Communications Configuration

Communications Settings	Default Value
DHCP	Enable
Device Name	WindowsCE
Primary DNS	0.0.0.0
Secondary DNS	0.0.0.0
Primary WINS	0.0.0.0
Secondary WINS	0.0.0.0

802.11 Radio Settings	Default Value
Network Name	INTERMEC
Infrastructure Mode	Infrastructure
Security	
Security Choice	Microsoft
Infrastructure Mode	Infrastructure
Network Authentication	Open
Data Encryption	Disabled
802.1x Authentication	Disabled
Network Key Setting	Automatic
Network Key Index	Key 1
Radio Power Management	Enabled (Fast PSP)

UDP Plus Settings	Default Value
UDP Plus Activate	Disable
Controller IP	0.0.0.0
Controller Port	5555
Ack Delay Upper Limit	5000 ms
Ack Delay Lower Limit	300 ms
Retries	7
Send Timer	20 sec
Receive Timer	45 sec

Appendix B — Default Configuration





Default Device Settings Configuration

Device Settings	Default Value
Beeper Volume	Very high
Backlight Timeout	1 minute
Power Management	
User Idle	1 minute
System Idle	1 minute
Suspend	1 minute



Index

Symbols and Numbers

- ← *See* Backspace key
-  *See* Network Connection icon
-  *See* Caps Lock icon
-  *See* Green key
-  *See* Green mode
-  *See* Orange key
- .NET Compact Framework, 3, 74
- 10-key scroll keypad, illustrated, 12
- 115200 bps, modem dock maximum, 64
- 18-key numeric keypad, illustrated, 10
- 1D linear imager
 - determining if installed, 4
 - reading distances, 105
- 802.11b/g radio
 - communications, configuring, 39
 - determining if installed, 4
 - Wi-Fi certified, 2
- 802.1x security
 - configuring
 - overview, 53
 - with Funk, 54
 - with Microsoft, 55
 - troubleshooting, 86 to 87

A

- abrasive material, avoiding, 101
- AC power source, unavailable, 26
- AC power supply, accessory described, 106
- accessing F1 to F12, 10
- accessing F3 to F5, 12
- accessories, described, 105
- ActiveSync
 - installing and establishing a partnership, 77
 - troubleshooting, 78
 - using to copy and install files, 78
 - using to install applications, 76
- ammonia and water for cleaning, 100
- antenna restructions, 39
- applications
 - developing
 - web-based, 75
 - with Intermec SDK, 74
 - installed by default, 3

- installing with
 - ActiveSync, 76
 - Avalanche, 80
 - SD card, 80
- launching automatically, 81
- problems after installing/removing, 86
- storing on the CN2, 76

Arrow keys, illustrated, 12

- attachments, downloading in email, 71
- audio feedback, *See* beeps
- Audio Test, diagnostics, 93
- Authentication server, properly configured, 45
- authentication, troubleshooting 802.1x
 - security, 86 to 87
- automatically launching your application, 81
- Avalanche, *See* Wavelink Avalanche
- Avalanche Enabler, password for exiting, 80

B

- backlight
 - Backlight Test, diagnostics, 92
 - Backlight Timeout recommendations, 9
 - togglng on or off, 13
- Backlight Test, diagnostics, 92
- Backspace key, using to delete characters, 11
- backup battery, time limit, 5
- bar codes
 - Good Read light, 20
 - scanning
 - determining if available, 4
 - how to, 21
 - reading distances, 105
 - troubleshooting, 90
 - supported symbologies, 105
 - symbologies, default, 21
 - test bar code, 22
- batch CN2, defined, 4
- battery
 - accessory, described, 105
 - Battery Information, diagnostics, 93
 - charging, 6
 - checking status, 9
 - described, 105

- battery (*continued*)
 - disposing of, 5
 - door latch, illustrated, 6
 - installing, 6
 - light
 - green, orange, or red, 20
 - illustrated, 19
 - maximizing life, 9
 - removing, 8, 24
 - status icons, 9
 - using, 5
- Battery Information, diagnostics, 93
- baud rate, maximum for modem dock, 64
- beeper volume, changing, 21
- beeps
 - Audio Test, diagnostics, 93
 - understanding, 20
 - volume, changing, 21
- bitmap graphics, 14
- booting
 - cold booting, 95
 - overview, 94
 - Reset button, 96
 - Warm Boot button, 95
 - warm booting, 94
- buttons, illustrated
 - Arrow, 12
 - Enter, 10, 12
 - Green, 10
 - Orange, 10, 12
 - Power, 10, 12
 - Reset, 96
 - Scan, 2, 12
 - Side Scan, 2
 - Warm Boot, 95
- C**
- CAB file, using to install applications, 75
- cable, USB, accessory described, 106
- calibrating, touch screen, 17
- Caps Lock icon, 11
- card, SD
 - contents appear in SDMMC Disk folder, 76
 - inserting, 23
 - removing, 24
 - using to install applications, 80
 - using to store application data, 76
- CCX v1.0 certification, 3
- CCX v1.0 compliance, 46
- certificates
 - loading for security, 59
 - Microsoft Active Directory, 46, 59
 - third-party certificate authority, 60
- charging, battery, 6
- Cisco access point, 57
- cleaning the scanner window and touch screen, 100
- CN, 4
- CN2
 - accessories list, 105
 - batch version, defined, 4
 - Bootloader Menu, 98
 - default configuration settings, 108 to 110
 - default software configuration, 86
 - description, 2
 - features, 3
 - hardware configuration, displayed, 93
 - installed applications, 3
 - operating system version, displayed, 93
 - power supply, accessory described, 106
 - serial port, illustrated, 2
 - toggling the backlight, 13
 - troubleshooting, guide to, 83
 - turning on and off, 13
 - upgrading, 96
 - USB/serial port, illustrated, 2
 - wireless version, defined, 4
- Codabar, 21
- Code 128, 21
- Code 39, 21
- cold boot, 95
- communications
 - default configuration settings, 109
 - Networking Test, diagnostics, 93
- communications dock
 - accessory, described, 105
 - charging the battery, 6
 - green Power light, 7
- Configuration number, 4
- configuration, default settings, 108

Index

configuring
802.11b/g radio communications, 39
802.1x security
 configuring, 53
 troubleshooting, 86 to 87
date and time, 96
LEAP security, 56
overview, 30
phone connection, 62
remotely with Intermec Settings, 36
security, 45
static WEP security, 57
TCP/IP network parameters, 40
UDP Plus network parameters, 42
USB communications, 38
using local Intermec Settings, 32
using Setup Assistant, 31
WPA security, 48
contact information for Intermec, ix
contents, in SDMMC Disk folder, 24
converting writing to text, using
 Transcriber, 16
copying files to CN2 using
 ActiveSync, 78
 SD card, 80
 Wavelink Avalanche, 80
copyright information, xi

D
date, configuring, 96
default configuration
 restoring, 35
 settings, 108
default configuration of CN2 software, 86
Dell Model SK-8115 USB keyboard, 25
desktop
 illustrated, 14
 understanding, 15
developing applications using the SDK, 74
diagnostics
 running, 92
 summary of tests, 92
dimensions, physical, 104
disabling security, 62
DiskOnChip folder, using to store
 application data, 76
Display Test, diagnostics, 93

documentation
 CN2 Communications Dock Quick Start Guide, 7
 CN2 Modem Dock Quick Start Guide, 26, 62
 downloading from web, ix
 Intermec Computer Command Reference Manual, 33
 MobileLAN access WA2X System Manual, 49, 53
 MobileLAN secure 802.1x Security Solution Installation Guide, 45
drag, defined, 14
dust cover, accessory described, 106

E

eboot.bin file, 97
electrical specifications, 104
email
 attachments, downloading, 71
 meeting requests, downloading, 71
 setting up, 69
 using, 71
Enabler, password for exiting, 80
Enroll Certificates application, 59
Enter key, illustrated, 10, 12
Enterprise mode of WPA, 48
environmental specifications, 104
exiting
 Avalanche Enabler, 80
 Intermec Settings, 35
Extensible Authentication Protocol (EAP), 48

F

F1 to F12, accessing, 10
F3 to F5, accessing, 12
factory default settings, restoring, 35
FAT16, 97
fingerprints, cleaning, 100
Funk Security
 configuring
 802.1x security, 54
 WEP, 58
 WPA security, 49
 WPA-PSK, 50
 selecting a profile, 47

- Funk Security (*continued*)
 - selecting as security choice, 46
 - supplicant, using, 46
- G**
- Good Read light
 - illustrated, 19
 - troubleshooting, 90
- Green key
 - illustrated, 10
 - using, 11
- Green mode, enabling, 11
- H**
- handstrap, accessory described, 106
- Hardware Configuration, diagnostics, 93
- holster, accessory described, 106
- host computer not receiving data,
 - troubleshooting, 88
- humidity, specifications, 104
- I**
- ICCU, *See* Intermec Settings
- icons
 - battery status, 9
 - taskbar, illustrated, 14
 - understanding screen, 18
- imager
 - 1D linear reading distances, 105
 - determining if installed, 4
- IMAP4 email server, 69
- Import Root utility, 59
- inserting
 - battery, 6
 - SD card, 23
- installing
 - ActiveSync, 77
 - applications using the SD card, 80
 - applications, problems afterward, 86
 - battery, 6
 - SD card, 23
- Intel XScale processor, 3
- Interleaved 2 of 5, 21
- Intermec Diagnostics
 - icon, illustrated, 92
 - running, 92
 - summary of tests, 92
- Intermec SDK, using to develop
 - applications, 74
- Intermec Settings
 - exiting, 35
 - navigating, 33
 - opening on the CN2, 32
 - package for Wavelink Avalanche, 36
 - restoring default settings, 35
 - saving, 34
 - using to remotely configure, 36
- Intermec telephone number, ix
- Internet Explorer, opening, 75
- Internet, configuring a connection to, 62
- IPv6 support, 3
- ISP, configuring a connection to, 62
- K**
- Keep Alive message, 88
- Keyboard port on modem dock,
 - illustrated, 26
- keyboard shortcuts, 27
- keyboard, USB, installing and using, 25
- keypads
 - dust cover, accessory, 106
 - numeric keypad
 - accessing function keys, 10
 - deleting characters, 11
 - illustrated, 10
 - typing characters, 11
 - typing uppercase characters, 11
 - scroll keypad
 - accessing function keys, 12
 - illustrated, 12
- L**
- labels, scanning, 21
- launching applications automatically, 81
- LEAP security, configuring, 56
- lights, status, described, 20
- Lightweight Extensible Authentication
 - Protocol (LEAP), described, 56
- lithium-ion battery, 5
- loading certificates for security, 59
- Logitech Model Y-BF37 USB keyboard,
 - 25

Index

M

manuals

CN2 Communications Dock Quick Start Guide, 7

CN2 Modem Dock Quick Start Guide, 26, 62

downloading from web, ix

Intermec Computer Command Reference Manual, 33

MobileLAN access WA2X System Manual, 49, 53

MobileLAN secure 802.1x Security Solution Installation Guide, 45

maximizing battery life, 9

meeting requests, downloading in email, 71

Memory Information, diagnostics, 93

Microsoft Active Directory, 46, 59

Microsoft ActiveSync, *See* ActiveSync

Microsoft C#, 74

Microsoft Embedded Visual C++, 74

Microsoft Security

configuring

802.1x security, 55

WEP, 58

WPA, 51

WPA-PSK, 52

required for Microsoft Wireless Zero Configuration, 43, 46

switching to, 48

using, 45

Microsoft Wireless Zero Configuration, *See* Wireless Zero Configuration

modem dock

accessory, described, 106

attaching USB keyboard, 25

configuring the CN2 to use, 62

maximum baud rate supported, 64

port

Keyboard, illustrated, 26

Phone, illustrated, 26

Power, illustrated, 26

USB, illustrated, 26

modes

Green mode, 11

Orange mode, 10, 12

Suspend mode, 13

MSI, 21

N

navigating in Intermec Settings, 33

network communications lost, 35

Network Connection icon, 18, 44, 86, 88, 89

network protocols supported, 39

Networking Test, diagnostics, 93

nk.bin file, 97

no network connection icon, troubleshooting, 89

numeric keypad, using, 10

O

operating system

displaying the version, 93

upgrading, 97

operating the CN2

humidity range, 104

temperature range, 104

troubleshooting, 84 to 85

optional features

1D linear imager, 3

802.11b/g radio, 3

keypad, 3

Orange key

illustrated, 10, 12

refreshing the selected folder, 11, 12

using, 10, 12

Orange mode, enabling, 10, 12

P

parameters, ways to configure, 30

passphrase

setting for Funk WPA-PSK, 51

setting for Microsoft WPA-PSK, 53

password for exiting Avalanche Enabler, 80

patent information, x

Persistent Storage Memory (PSM), upgrading, 99

phone connection, configuring, 62

Phone port on modem dock, illustrated, 26

physical

dimensions, 104

specifications, 104

POP3 email server, 69

- Power key
 - illustrated, 10, 12
 - using, 13
- Power port on modem dock, illustrated, 26
- power specifications, 104
- power supply, accessory described, 106
- Pre-Shared key Mode, WPA, 48
- problems, finding and solving, 84
- profile, selecting for Funk security, 47
- Protected Extensible Authentication Protocol (PEAP), described, 53
- PSK mode of WPA, 48
- pull-tab, on an SD card, 22
- R**
- radio
 - communications, configuring, 39
 - determining if installed, 4
 - Wi-Fi certified, 2
- Radio Power Management parameter, 9
- RAM, Memory Information, diagnostics, 93
- reading distances, 1D linear imager, 105
- refresh, 11, 12
- registry, resetting, 86
- remotely managing the CN2, using
 - Avalanche, 80
- removing
 - applications, problems afterward, 86
 - battery, 8, 24
 - SD card, 24
- Reset button, illustrated, 96
- Reset Registry button, 86
- resource kits, 74
- restoring default settings, 35
- S**
- safety
 - icons, viii
 - summary, vii
- SanDisk SD cards, 22
- Save icon, illustrated, 34
- saving, Intermec Settings, 34
- Scan buttons
 - illustrated, 12
 - troubleshooting, 90
- ScanDemo, using, 15
- scanner
 - cleaning the window, 100
 - default configuration settings, 108
 - reading distances, 105
 - troubleshooting, 90
 - window, illustrated, 100
- scanning bar codes, 21
 - described, 21
 - determining if available, 4
 - using ScanDemo application, 15
- screen, *See also* touch screen
 - Backlight Test, diagnostics, 92
 - cleaning, 100
 - Display Test, diagnostics, 93
 - specifications, 104
 - Touch Screen Test, diagnostics, 93
- screen icons, understanding, 18
- scroll keypad, using, 12
- SD card
 - accessing files, 24
 - attaching a pull-tab, 22
 - contents, in SDMMC Disk folder, 76
 - inserting, 23
 - removing, 24
 - required to upgrade operating system, 97
 - using to copy and install files, 80
 - using to install applications, 80
 - using to store application data, 76
 - using to upgrade operating system, 97
- SDMMC Disk folder, using to store
 - application data, 76
- secure digital card, *See* SD card
- security
 - configuring
 - 802.1x, 53
 - LEAP, 56
 - overview, 45
 - WEP, 57
 - WPA, 48
 - disabling, 62
 - loading certificates, 59
 - using Microsoft Security, 45
 - using the Funk supplicant, 46
 - Wireless Zero Configuration, 43
- security choice, Microsoft or Funk, 45

Index

- serial adapter, accessory described, 106
- serial port, illustrated, 2
- settings, restoring default, 35
- Setup Assistant, using to configure CN2, 31
- Shift key (scroll keypad), *See* Orange key
- Side Scan buttons
 - illustrated, 2
 - troubleshooting, 90
- SMTP gateway, 69
- soft keyboard, 27, 33
- software configuration, default, 86
- Software Input Panel (SIP), 27
- sound, Audio Test, diagnostics, 93
- sounds, *See* beeps
- specifications
 - 1D linear imager reading distances, 105
 - electrical, 104
 - humidity, 104
 - power, 104
 - screen, 104
 - temperature, 104
- start screen
 - illustrated, 14
 - understanding, 15
- static WEP security, configuring, 57
- status
 - beeps, understanding, 20
 - checking battery, 9
 - lights, understanding, 19
- status bar, *See* taskbar
- storing your application on the CN2, 76
- stylus
 - calibrating the touch screen, 17
 - using with touch screen, 14
- Suspend mode, described, 13
- SWLD26C1 configuration window, 44
- symbolgies
 - disabled incorrectly, 36, 91
- symbolgies, bar code
 - default, 21
 - supported, 105
- T**
- tab, on an SD card, 22
- tap and hold, defined, 14
- tap, defined, 14
- taskbar
 - illustrated, 14
 - understanding, 15
- TCP/IP
 - network diagram, 40
 - network, configuring parameters, 40
- technical support
 - accessing on web, ix
 - sending CN2 for repair, 94
 - services, listed, ix
 - telephone access, ix
 - viewing the operating system version, 93
- telephone access to technical support, ix
- temperature, specifications, 104
- tests
 - running diagnostics, 91 to 93
 - summary of diagnostic tests, 92
- third-party certificate authority, 60
- time, configuring, 96
- TKIP, using with WPA, 48
- touch screen
 - calibrating, 17
 - cleaning, 100
 - icons, understanding, 18
 - illustrated, 100
 - Touch Screen Test, diagnostics, 93
 - using with stylus, 14
- Touch Screen Test, diagnostics, 93
- Transcriber, using, 16
- Transport Layer Security (TLS), described, 53
- troubleshooting
 - bar code symbolgies, 91
 - configuring 802.1x security, 86 to 87
 - diagnostic tests, 91 to 93
 - guide to finding solutions, 83
 - lost network connection after suspend, 88
 - Network Connection icon, 86, 88, 89
 - operating the CN2, 84 to 85
 - scanning bar codes, 90
 - wireless connectivity, 88 to 89
- trusted root certificate, 59
- turn on/off the CN2, 13

U

- UDP Plus
 - network diagram, 42
 - network, configuring parameters, 42
 - understanding
 - screen icons, 18
 - status lights, 19
 - unexpected behavior, 86
 - Unicode characters, 14
 - unique client certificate, 59
 - UPC/EAN, 21
 - upgrading
 - operating system, 97
 - Persistent Storage Memory (PSM), 99
 - USB communications
 - configuring, 38
 - network diagram, 38
 - USB interface cable, accessory, 106
 - USB Host Power parameter, 26
 - USB interface cable, accessory described, 106
 - USB keyboard
 - installing and using, 25
 - supported models, 25
 - USB port on modem dock, illustrated, 26
 - USB/serial port, illustrated, 2
 - User Certificates utility, 59
 - user-programmable fonts, 14
 - using
 - battery, 5
 - Green key, 11
 - Orange key, 10, 12
 - Power key, 13
 - SD card, 22
 - touch screen, 14
 - USB keyboard, 27
 - Utilities icon, 26, 86
- V**
- version, operating system, 93
 - Visual Basic .NET, 74
 - volume, beeper, changing, 21

W

- Warm Boot button, illustrated, 95
 - warm booting, 94
 - warranty information, viii
 - Wavelink Avalanche
 - Agent, 80
 - package for CN2, 36
 - password for exiting Enabler, 80
 - using to copy and install files, 80
 - using to remotely manage the CN2, 80
 - WEP security, configuring, 57
 - Wi-Fi certified, 2
 - Wi-Fi Protected Access (WPA) security, 48
 - Windows keyboard shortcuts, 27
 - wireless CN2, defined, 4
 - wireless communications
 - configuring, 39
 - troubleshooting, 88 to 89
 - Wireless Information tab, 44
 - Wireless Zero Configuration
 - requires Microsoft Security, 46
 - using on CN2, 43
 - Wireless Information tab, 44, 45
 - WPA security
 - configuring with Funk, 49
 - configuring with Microsoft, 51
 - described, 48
 - WPA-PSK security
 - configuring with Funk, 50
 - configuring with Microsoft, 52
 - described, 48
 - writing on touch screen, converting with Transcriber, 16
- X, Y, Z**
- XScale processor, 3
 - yellow Power key, 13
 - Zero Config, *See* Wireless Zero Configuration

Index



Corporate Headquarters
6001 36th Avenue West
Everett, Washington 98203
U.S.A.

tel 425.348.2600

fax 425.355.9551

www.intermec.com

CN2 Handheld Computer User's Manual



P/N 075464-001