



Mobile Phone



Operating Instructions

PowerTel M4000



HAC Hearing Aid Compatible to M3 / T3 Rating

The M4000 Phone has a built in Induction Coil and is hearing aid compatible.

To ensure optimum benefit, users with hearing aids may wish to select the T setting on their hearing aids.



Exposure to the receiver at full volume for a long period could cause ear damage.

Contents

1	Quick Start Guide	4
2	At a Glance	16
3	How does it work	20
4	Getting Started	24
5	Phone Book Set Up	29
6	Making and Receiving Calls	35
7	Calls List	39
8	SMS - Text Messages	40
9	Voice Mail	45
10	Other Useful Features	47
11	SIM Tool Kit	67
12	Menu Structure	68
13	Trouble Shooting	77
14	Technical Properties	80
15	Safety Information	84
16	Maintenance / Guarantee	89
17	Index	91

Quick Start Guide

1 Quick Start Guide



Important: Before you start, please read the safety information on page 84.

Quick Glance

- 1 LED
- 2 Earpiece
- 3 Display
- 4 Navigation keys (scroll up/down)
- 5 Softkey, left
- 6 Call key
- 7 One-touch dialling keys
- 8 Star key / Ringer On/Off - Silent Mode
- 9 Softkey, right
- 10 On/Off key / End call key
- 11 Keypad
- 12 Hash key
- 13 Microphone
- 14 Charge contacts
- 15 Mini USB socket
- 16 Headset socket (Headset not supplied)

Quick Start Guide

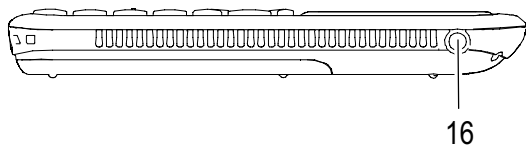
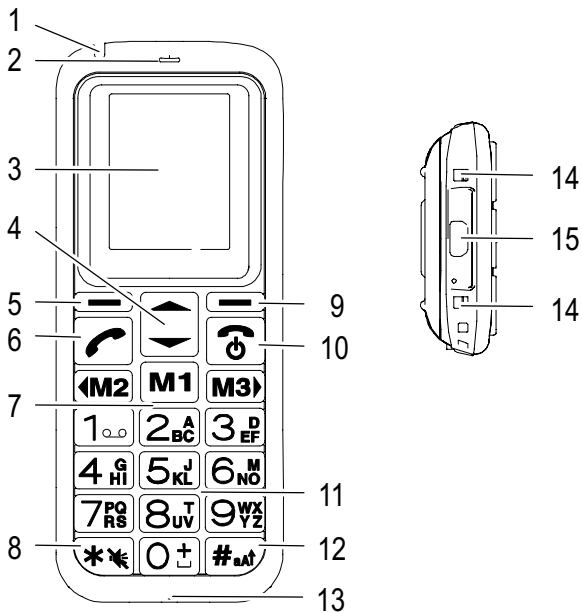

Quick Start Guide

What is in the box

The package contains:

1 mobile phone

1 desktop charging unit

1 li-ion battery

1 operating manual

1 charging cable

Installing the SIM card



Risk of swallowing small objects!

The SIM card can be removed.

Small children can swallow them.

Switch the phone off.



Pay attention that the SIM card is not bent or scratched. Prevent any contact with water, dirt or electrical charges.

Slide the mobile phone's battery compartment cover towards the bottom using a little force. Lift the battery compartment cover off the phone completely.

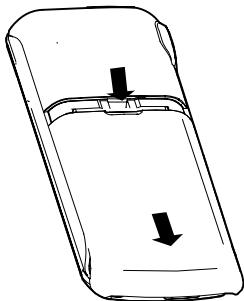

If there is already a battery inside, remove it.

Quick Start Guide



Your telephone number is carried by the SIM card, not the phone. Therefore if you use a SIM card you had in a previous phone, you will keep the same phone number.

Slide the SIM card with the golden contacts facing down in the SIM card holder provided for it at the top right. The SIM card must be located under the metal retaining bar to be in the correct position.

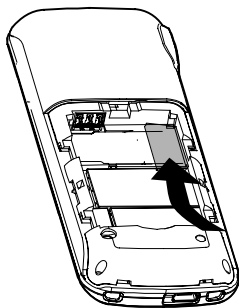

Insert the battery. The golden contacts on the battery must face towards the top left. Press lightly on the bottom end of the battery until it snaps into place.

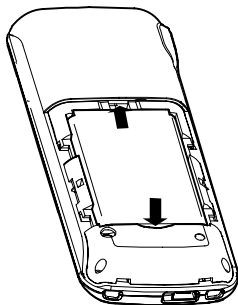

Quick Start Guide

Replace the battery compartment cover back on the phone. Slide the battery compartment cover upwards until it snaps in to place.

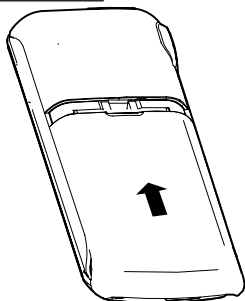

Charging the battery



Before starting to charge the battery, check that it has been installed properly. Do not remove the battery while it is being charged. This could damage the phone.



When charging the battery for the first time, it should be charged for **at least** 4 hours. Some batteries only reach their full capacity after several complete charge/discharge cycles.

Charging via the mini USB socket
Plug the power adapter in the mini USB port.

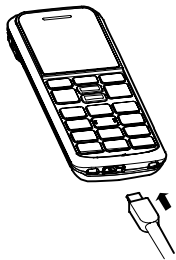

Quick Start Guide

Connect the power adapter plug as illustrated in the diagram. For safety reasons, only use the power adapter plug supplied.

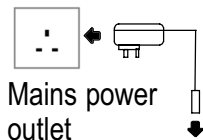

Charging via the desktop charging unit

Plug the power adapter in the mini USB socket on the charging unit. Insert the phone in the charging unit to charge it.

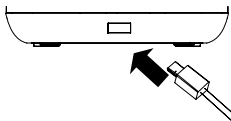

 The display will go blank but even so the battery is still being charged. This is correct operation.

 It may take a few seconds before the phone indicates the charging process. You can use the phone during the charging process.

Battery status warning

The current **battery charge status** is indicated in the display as follows:



Full



Half empty



Low



Empty

Quick Start Guide

When the battery charge is low, a corresponding warning message appears in the display.



Charge the battery.

In cases where the battery charge is extremely low, it is possible that the back-lighting no longer works and certain functions are no longer available.

When the battery charge drops below the minimum status, the phone switches off automatically.

Switching the mobile phone on and off

3 sec.



Switch the mobile phone on

3 sec.



Switch the mobile phone off



Some SIM cards will require you to enter a PIN code. Follow the prompts on the screen or read more details about PIN & PIN2 on Page 58.

Make sure you are in range of your Network

Some networks offer better coverage than others in different areas. The icon  indicates you have a signal and are connected to the network. The network will also appear in the display.

Setting the display language

If you want to select a different language please refer to Page 50.

The following languages are available: German, English, French and Dutch.

Setting the time and date

Refer to Page 49.

Setting the loudest Ringer

Refer to Page 60.

Now you are ready to make and receive calls.

Taking a call



Take the call

Rejecting a call



Reject the call

Ending a call



Ending a call (on-hook)

Making a call



Enter the phone number

Clear

Delete the last number if incorrect





Dial the phone number

Quick Start Guide

Advanced Settings and Functions

For more details about setting up your Amplicomms M4000 and other functions follow the descriptions in this user guide.

Examples;

- Set your one-touch dialling keys;  Page 47.
- Store numbers in the phone book;  Page 26.
- Use the Index;  Page 91.



If you have any questions please call the Service-Hotline: 0844 800 6503 (Using an UK landline, at the time of going to print: calls cost 6p for connection charge and then 5p a minute. Mobile costs may vary.)

Questions and Answers



In the majority of cases your M6000 phone is supplied without a SIM card. You may find the following “**Questions and Answers**” (Q & A) helpful.

Q - Why hasn't the mobile phone been supplied with a SIM card?

A - Many people already have a mobile phone and wish to transfer their existing SIM card over to the new phone. This has the advantage of keeping the same telephone number and if the card is subscribed to a Pay-as-you-go service then you also benefit from being able to carry over any credit that has

been paid the card.

Q - Where can I get a SIM card from?

A - Any high street mobile phone shop will be able to provide you with a SIM card. Some of the major supermarket chains also provide mobile phone services and can supply a SIM card. A useful tip when choosing a SIM card / service provider however is to make sure that you have adequate signal coverage at home; this particularly important if you live in a very rural area.

Q - Why doesn't the Amplicomms mobile phone have a telephone number?

A - The telephone number is supplied by the service provider and will be registered onto the SIM card.

Q - Can I use the SIM card from my old mobile phone?

A - Yes as long as the SIM card is less than three years old you can transfer the card over. Some old SIM cards however are not compatible with the Amplicomms mobile phone as they are from an earlier generation of SIM card design.

Q - Can I use a SIM card from any mobile phone company?

Quick Start Guide

A - Yes. The Amplicomms mobile phone is what is termed as an open SIM card phone and so it is not restricted to any particular service provider or mobile phone company.

Q - How do I pay for my calls?

A - There are two main types of registration with a service provider or mobile phone company. One is a contract - this is where you sign up for agreed contract over several months / year and pay an agreed monthly fee. This is more suited to people who are using their mobile phone as part of their job for example. The other is Pay-as-you-go, sometimes abbreviated to PAYG. With this type of service you add credit to the card and top up as and when required. Topping up the card is easy, you can do this over the phone, on-line, at many shops and even some cash points allow you to do this. PAYG is more suited to less frequent users.

Q - How do I find out my credit balance?

A - The service provider of the SIM card should have provided an information pack with the card. This will give details of a short number to dial in order to check your balance. These access codes differ between mobile phone companies so please check the details specific to your service provider. Key in your number, press the talk button and the credit balance will be announced to you.

Notes

At a Glance

2 At a Glance





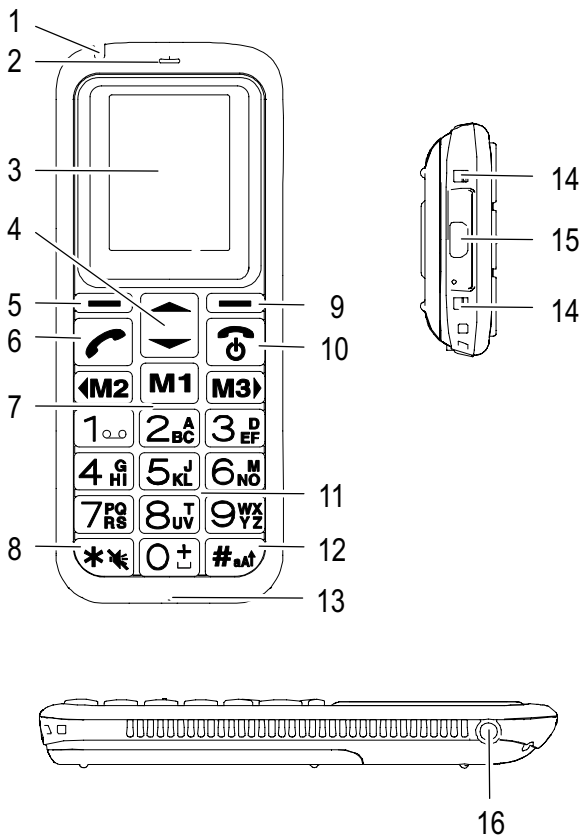



Keys and Parts

- 1 LED
- 2 Earpiece
- 3 Display
- 4 Navigation keys (scroll up/down)
- 5 Softkey, left
- 6 Call key
- 7 One-touch dialling keys
- 8 Star key / Ringer On/Off - Silent Mode
- 9 Softkey, right
- 10 On/Off key / End call key
- 11 Keypad
- 12 Hash key
- 13 Microphone
- 14 Charge contacts
- 15 Mini USB socket
- 16 Headset socket (Headset not supplied)











At a Glance

Icons and texts in the handset display

Icon	Description
	Displays the battery capacity. Running-through segments : the battery is being charged.
	Charge the battery.
	Signal strength of the phone connection.
	Alarm is activated.
	A headset is connected.
	The key lock function is activated; ☞ Page 37.
	A roaming ¹ call is in progress.
	Call forwarding is active.
	There are new calls in the call list; ☞ Page 39.

¹ Cost of roaming calls and SMS will vary considerably from country to country. Check with your Operator.

At a Glance

	A new SMS ¹ text message has been received;  Page 40.
	SMS text memory is full;  Page 44.
	Ringing tone only is activated
	Vibration alert only is activated
	Vibration alert and ringing tone are activated
	The volume is set high and care should be taken when using the phone.

¹ **SMS: Short Message Service** = Service for sending text messages.

How does it work

3 How does it work









1 LED Indicates the phone operating status. The LED will stay on while charging and will flash if no signal is detected or no network to be clamp on to alert the user.

2 Earpiece The voice of the caller can be heard here when no headset is being worn and the device not set to Handsfree mode.





3 Display The information which appears in the display guides you through the menu structure and helps operate the mobile phone.

4  Navigation keys Use the Navigation keys to scroll through the menus and select settings.

How does it work

-
- 5  Softkey, left The softkeys are assigned different functions in the various menus. The function currently assigned is always indicated by a word in the display directly above the softkey.
-
- 6  Call key Take a call or dial a number. Redial.
-
- 7    One-touch dialling keys
A phone number can be assigned to each one-touch dialling key and then dialled directly by pressing and holding the respective key. In addition:
  = Scroll left/right, e.g. to program settings in the Alarm menu.
-
- 8  Star key Enter special characters.
Ringer On / Off - Silent Mode

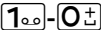

How does it work

- 9  Softkey, right The softkeys are assigned different functions in the various menus. The function currently assigned is always indicated by a word in the display directly above the softkey.
-
- 10  On/Off key, End call key Switch the mobile phone on and off.
Cancel the current process.
End or reject a call.
-
- 11  Keypad Enter phone numbers and names or write a text.
-
- 12  Hash key Activate the key lock.
Switch between upper/lower case and numbers.
-
- 13 Microphone Is activated during a call.
-
- 14 Charging contacts The phone is charged via these contacts when in the charging unit.
-
- 15 Mini USB socket For connecting the power adapter plug.

How does it work

- 16  Headset socket (Headset not supplied)
Connect a headset.
The earpiece, loudspeaker and microphone are deactivated. You can only hear and speak via the headset.

Special Function Keys

Mode	Press and hold 	Press and hold 
Standby	Ringer On / Off - Silent Mode	Activate the key lock

This icon  will appear in the display.









Press and hold  A connection is established to your mailbox and you can listen to your messages;
 Page 45.

Getting Started

4 Getting Started

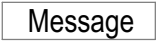
This chapter provides basic information on using the operating instruction manual and the telephone.

Description of operating sequences in the manual

Display	Description
	Press the key depicted briefly
2 sec. 	Press the key depicted for 2 seconds
Hold 	Press and hold down the key depicted
	Enter numbers or letters
	Mobile phone rings
	Represents text in the display
	Indicates icons in the display
	Press the softkey;  Page 25



Standby mode



All descriptions in this operating manual assume that the mobile phone is in Standby mode. The system is switched to Standby mode by pressing the  key, several times if necessary. It may be necessary to deactivate the key lock function.

Energy-save mode

When the phone has been in Standby mode for some time, it automatically switches to energy-save mode. The display no longer lights up. Press any key to reactivate Standby mode.



Softkeys

The  and  softkeys are assigned different functions in the various menus. The softkeys are always referred to in this manual according to the word directly above them in the display.











Key	In Standby mode	In a menu
 left	- Open the main menu	- Various functions
 right	- Open the phone book	- Various functions

Navigating in the menu

All the functions can be accessed via the various menus. Refer to Menu Structure,  Page 68, for information on how to access each respective function.













Menu	Open the main menu
 / 	Select the submenu required
OK	Open the submenu

Getting Started

 / 	Select the function required
	Open the function
 /  	Select the setting required
	Use the keypad to enter numbers or letters
 (left)	Confirm the entries
 (right)	Move one level back
	Cancel the programming and saving processes and return to Standby mode

Creating phone book entries - example

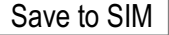
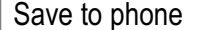
The way in which to navigate through the menus and define settings is explained by means of the example **Creating phone book entries**. Proceed as in this example for all the settings.

	Open the main menu
 /   	Select the phone book (Contacts) and confirm it
 /   	Select the submenu and confirm it
 /   or  	

How to enter text and numbers

Select the memory location and confirm it



Enter the name and confirm it



Enter the number and confirm it

How to enter text and numbers

The keypad is labelled with letters for the entry of text.

The phone provides various methods by which text can be entered. These are used when creating or editing contacts in the phone book, when searching for names in the phone book and when writing SMS text messages.



Not every method is always available for each application.

Methods of entering text

Multitap

In order to enter text in Multitap mode, press the key labelled with the corresponding letter/character. If the first character of the group is required, press the key once. If the second character is required, press it twice, and so on.

How to enter text and numbers









To enter two characters assigned to the same key, press the key the respective number of times to enter the first character. Then wait for approx. 2 sec. and enter the second letter.

ABC	Multitap upper case
abc	Multitap lower case
ABC	The first character of a new sentence will be upper case and the rest is lower case.
123	Numbers





To switch between the text and numbers, press the  key.

Punctuation and special characters



When in Editing mode, press the  key. Punctuation marks and special characters are displayed. Use the  /  and  /  keys to select the required character and insert it by pressing the **OK** softkey. A wide range of frequently used special characters are available when editing by repeatedly pressing the  key.

Other entries and functions

	Enter a space
Delete	Delete character
 / 	Move the cursor

5 Phone Book Set Up

The phone book in the phone can store up to 200 entries.

- Always enter the area code and country codes with all the phone numbers.
- When the memory capacity is used up, the corresponding message appears when an attempt is made to store another entry. Before new entries can be stored, old entries must be deleted.
- The phone book entries are arranged alphabetically. To skip directly to a required phone book entry, press the corresponding first letter. To search for the entries manually, use the  /  keys.



Your provider can state how many entries you can store on your SIM card.

Entering names

The keypad is labelled with letters for the entry of names. Press the corresponding key the respective number of times to enter letters. Information on ways of entering text;  Page 27.

Phone Book Set Up

Creating phone book entries

See  Page 26.

Saving in Standby mode



Enter the phone number

Options

Open the Options menu

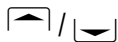

Save number OK

Start the saving process

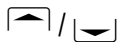

Save to SIM or

Save to phone OK

Select the memory location
and confirm it



OK

Enter the name and confirm it



OK

Edit the number and confirm it

Modifying, editing, deleting phone book entries

Menu

Open the main menu

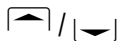

Contacts OK

Select “Contacts” and confirm
it

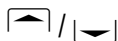

View contacts OK

Select the submenu and
confirm it







Search for the required entry as described at the beginning of this chapter.

Phone Book Set Up



Options	Open the Options menu
The following functions can be used:	
View	View/Edit the entry
Send SMS	Send the SMS text
Add to group	Assign the number to a group
Copy to phone	Copy the entry (SIM → phone)
Copy to SIM	Copy the entry (phone → SIM)
Call	Dial the entry
Delete	Delete the entry

Execute the functions and then confirm them.

Copying or deleting all entries

Menu	Open the main menu
 /  Contacts	OK Select "Contacts" (phone book) and confirm it
 /  Advance	OK Select the submenu and confirm it
 /  Copy all	OK Copy entries (SIM or phone)

Phone Book Set Up

 /  Delete all contacts 

Delete all the entries
(SIM or phone)



Execute the functions and then confirm them.

Groups



You can assign the entries to various groups. These groups can then be allocated different ringing melodies.

Assigning an entry to a group

 Open the main menu

 /  Contacts 



Select “Contacts” and confirm it

 /  View groups 

Select the submenu and confirm it

 /  Friends 

Select the group and confirm it



 /  Group member 



Open the list

  /  Add member 

Initiate adding a member



Phone Book Set Up



 /  **Add** Select an entry from the list and add it



 All the entries stored in the phone are then displayed. Entries which are stored on the SIM card are not displayed and cannot be selected! Copy the entries from the SIM card to the phone as necessary;  Page 30.



Editing group names

Menu Open the main menu

 /  **Contacts** **OK** Select the menu and confirm

 /  **View groups** **OK** Select the menu and confirm

 /  **Friends** **OK** Select the group and confirm it

 /  **Rename** **OK** Initiate renaming



Delete Delete the existing group name letter-by-letter



 **Save** Enter the new group name using the keypad and then confirm it



Phone Book Set Up



Changing the ringer for groups



Menu Open the main menu

 /  **Contacts** **OK**
Select "Contacts" and confirm it

 /  **View groups** **OK**
Select the submenu and confirm it

 /  **Friends** **OK**
Select the group and confirm it

 /  **Alert tone** **OK**
Open the menu

 /  **OK**
Select the ringer and confirm it

Making and Receiving Calls

6 Making and Receiving Calls

Taking a call

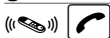

Take the call

Rejecting a call

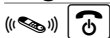

Reject the call

Ending a call



Ending a call (on-hook)

Making a call



Enter the phone number

Clear

Delete the last number if incorrect



Dial the phone number

Call list

Your mobile phone stores the last numbers dialled (**redialling**) as well as **calls** received and missed in a call list.



Open the call list

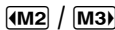

Select a calls list



Select the entry and dial it

Dialling numbers from the phone book

You must have already stored phone numbers in the phone book;  Pages 26.

Contacts

Open the phone book

Making and Receiving Calls



Select the entry and dial it



To skip directly to an entry, use the keypad to enter the first letters of the name stored. If necessary, you must press a key several times in order to enter the respective letters.

One-touch dialling keys

You must have already assigned phone numbers to the one-touch keys; Page 47.

3 sec. **M1**, **M2** or **M3**

Press and hold the one-touch dialling key

Setting the receiver volume

The volume can be adjusted during a call.

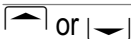

Select a volume level



Exposure to the receiver at full volume for a long period could cause ear damage.

Talk time display

The duration of a call is displayed in hours, minutes and seconds during the call.

Handsfree

This function is used to listen to the caller via the loudspeaker.

While a call is in progress

H/free

Activate the handsfree facility

Making and Receiving Calls

Normal

Deactivate the handsfree facility

Muting the microphone in the handset

The microphone in the handset can be activated and deactivated during a telephone conversation.

Options

Open the menu

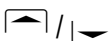

Mute

OK

Deactivate the microphone (muting function activated)

Unmute

OK

Activate the microphone

Keypad lock

The keypad lock is intended to prevent functions being triggered unintentionally.

3 sec.

Activate the key lock function



Calls can still be taken in the normal way even when the key lock function is activated.

Unlock

and then

immediately
Deactivate the key lock function

Turn ringer Off/On

The ringer can be set to silent - vibrate only.

3 sec.

Switch the ringer off

3 sec.

Switch the ringer on

Making and Receiving Calls

When you have set the ringer "Off" you will notice this icon  in the display.

Deactivating the ringer for the current call

Options

Mute

OK

Switch off the ringer



The ringer is automatically activated for the next incoming call.

Options during a call

Options

Open the "Options" menu

This menu provides access to functions which can be executed during a call:

Hold

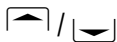

Hold

OK

Put the current call on hold



When a call is put on hold, the menu option changes to "Unhold".

Take back the call previously put on hold:

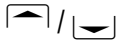

Unhold

OK

Resume the call

Contacts (phone book)

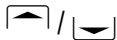

View contacts

OK







Open the phone book and view the entries

7 Calls List

The mobile phone is equipped with a calls list. Your mobile stores the last phone numbers dialled, taken and received but missed.

 If one of the phone numbers received matches an entry in the phone book, the associated name appears.

Dialling from the calls list

	Open the calls list
 M2 / M3 	Select a calls list
 /  	Select an entry and dial it

Displaying list details

Open the calls list.

 /  Options	Select an entry and open the Options menu
--	---

The following functions are available:

Call	Dial the entry
Send SMS	Send the SMS text
Delete	Delete the entry
Save number	Save the entry
Delete all	Delete the entire call list
Show number	Display the telephone number

SMS - Text Messages

8 SMS - Text Messages



It is possible that not all functions described are supported by every provider. Therefore, please contact your local mobile phone provider for details.

SMS settings



The distribution of text messages is performed via a Service Center (**SMSC**)¹. If you want to send and receive text messages, you must program a Service Center number in your phone. Normally, this has already been set up by your service provider.

Menu

Open the main menu

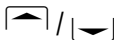

Message

OK

Select the menu and confirm it

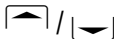

Message settings

OK

Select the submenu and confirm it

¹ **SMSC: Short Message Service Center** = Service center controlling the transfer of text messages.

SMS - Text Messages

SMS service center

Navigate to the “Message settings” submenu.

 /  SMS center number 

Select the submenu and confirm it



 

Enter or edit the **SMSC** number and save the setting

Validity

You can use the menu option to define how long an attempt should be made to deliver a message which you have sent.

Navigate to the “Message settings” submenu.

 /  Validity period 

Select the submenu and confirm it

There are 5 different settings available for selection.



 /  

Select the duration and confirm it

Delivery report

The corresponding confirmation is received after sending a text.

Navigate to the “Message settings” submenu.

 /  Delivery report 

Select the menu and confirm



SMS - Text Messages

 /  On softkey or  

Activate/Deactivate the delivery report and confirm it

SMS memory status

Navigate to the "Message" menu.

 /  Memory status 

Select the submenu and confirm it



The memory locations occupied and free on the mobile phone and SIM card are displayed.

Writing an SMS text





A text message can contain up to 457 characters, including spaces. A standard message contains 160 characters. Additional costs may ensue in the case of messages containing more than 160 characters.



Open the main menu

 /  Message 

Select the menu and confirm it

 /  Write message 

Select the submenu and confirm it

SMS - Text Messages



Write the text.



Information on ways of entering text;

Page 27.

Options

Open the menu

The following functions are available

Send

OK



or

Search

Enter the number or select one from the phone book

Save

OK

The SMS text is saved in the Drafts folder.

Send to many

OK

The message can be sent to several recipients selected from the phone book.

Templates

OK

Select a template for your SMS text.

Execute the functions and then confirm them.

SMS text messages sent and received



Texts received are indicated by a ringing tone which you have set. A corresponding message appears in the display.

SMS texts received are stored in the “Inbox” folder.



SMS texts sent are stored in the “Sent message” folder.

SMS - Text Messages

Editing stored texts

Menu Open the main menu

 /  **Message** **OK**
Select the menu and confirm it

 /  **Inbox** or
Sent message **OK**
Select the submenu and confirm it

Select SMS  /  **OK**
Select SMS text and confirm

Options Open the menu

The following functions are available:

Reply Reply to the number from which the text was sent

Forward Forward the text to a different number

Call Call the number from which the text was sent

Save number Store the number from which the text was sent

Delete Delete the SMS text

Delete all Delete all the SMS texts

Execute the functions and then confirm them.







9 Voice Mail



It is possible that not all functions described are supported by every provider. Therefore, please contact your local mobile phone provider for details. They may concern services which are subject to charges.



In order to use the “Voice Mail”¹ feature, the relevant phone number must be programmed in your mobile phone. Normally, this has already been set up by your service provider.

Setting up the Voice Mail feature

Menu	Open the main menu
 /  Contacts	OK Select the menu and confirm it
 /  Special numbers	OK Select the submenu and confirm it
 /  Voice mail	OK Select the submenu and confirm it

¹ Voice Mail, also referred to as mailbox (answering machine in mobile telecommunication network)

Voice Mail

 /  Number 

Select the submenu and start editing

Enter or edit the voice mail number and save it

The following functions are also available in the “Voice mail” menu:

Connect to voice mail 

The voice mail number is dialled.

Execute the functions and then confirm them.

Playing the Voice Mail messages

Navigate to the “Connect to voice mail” menu option, as previously described, and press the  softkey or

Hold 









A connection is established to your “Voice Mail” and you can play messages recorded.

10 Other Useful Features

One-touch dialling keys



It is possible to assign phone numbers to the one-touch dialling keys **M1**, **M2** or **M3** which are then dialled directly by pressing and holding the corresponding key;  Page 36.

Assigning a phone number to a one-touch dialling key:

Menu	Open the main menu
 /  Contacts OK	Select the menu and confirm it
 /  Advance OK	Select the submenu and confirm it
 /  M1 M2 M3 OK	Select the submenu and confirm it
 /  OK	Select the one-touch dialling key and confirm it
 OK	Enter the number and confirm it

Other Useful Features

Speed dialling

Phone numbers can be assigned to the keypad  to . Then hold the corresponding key pressed longer than 3 seconds to dial the corresponding number.



Each number you want to define as a speed dial number must be stored in the phone book.

Menu

Open the main menu

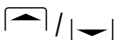

Contacts

OK

Select the menu and confirm

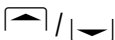

Advance

OK

Select the submenu and confirm it

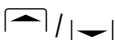

Speed dial

OK

Select the submenu and confirm it

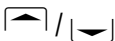

OK

Select the speed dial key and confirm it

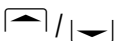

Set/Change

OK

Select the function and confirm it

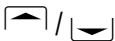

OK













Select the number and confirm it

Other Useful Features

Date and time

This menu option can be used to set and change the date and time.



To open the menu:

Menu	Open the main menu
 /  Settings OK	Select the menu and confirm it
 /  General OK	Select the submenu and confirm it
 /  Time and date OK	Select the submenu and confirm it
 /  Date & time settings OK	Select the submenu and confirm it
 	Enter day/month/year and jump to time
 OK	Enter hours:minutes and confirm it
 /  Date format OK	Select the submenu and confirm it

Other Useful Features

DD/MM/YYYY  /  OK



Select “(DD-MM-YYYY)”,
“(MM-DD-YYYY)” or
“(YYYY-MM-DD)”
and confirm it

 /  Date separator OK

Select the submenu and
confirm it

01/01/2010  /  OK

Select “-” “/” “.” or “ ” and
confirm it

 /  Time format: OK

Select the submenu and
confirm it

24 Hours  /  OK

Select “12 Hours” or “24 Hours” and confirm it

Language

This menu option can be used to set and change the display language.

Menu  Open the main menu





 /  Settings OK

Select the menu and confirm it

 /  General OK





















Select the menu and confirm it

Other Useful Features

-  /  Language  Select the menu and confirm it
-
-  /  OK Select your preferred language and confirm it

Alarm

This menu option can be used to programme 3 different alarms.

-  Menu Open the main menu
-
-  /  Tools  Select the menu and confirm it
-
-  /  Alarm  Select the menu and confirm it
-
-  /  Alarm 1  Select an alarm and confirm it
-
-   / ,  Select "Once", "Mon~Fri", "Everyday" or "Off" and jump down
-
-  ,  Enter hours:minutes and jump to Tone
-
-   / ,  Select a tone and confirm it

Other Useful Features

Calculator

This feature provides a simple calculator feature with which to solve simple, basic calculations.

Use the \uparrow and \downarrow keys to select the required arithmetic operation (+, -, x, \div).

Use the $\ast\text{€}$ key to set the decimal point.

Use the $\#_{aA}$ key to change the sign (\pm).

Menu

Open the main menu

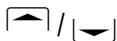

Tools

OK

Select the menu and confirm it

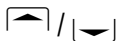

Calculator

OK

Select the submenu and confirm it

Example

To execute the calculation “-5 x 2.5 “ you have to type the following keys;

5_{KL}^J $\#_{aA}$ = -5

\uparrow \uparrow \uparrow = x





2_{BC}^A $\ast\text{€}$ 5_{KL}^J = 2.5





OK = -12.5

Clear = Delete





Other Useful Features

Calendar

This menu option opens the calendar. You can select other days. Use the  /  and  /  keys to navigate.

Menu	Open the main menu
 /  Tools OK	Select the menu and confirm it
 /  Calendar OK	Select the menu and confirm it

Stopwatch

Menu	Open the main menu
 /  Tools OK	Select the menu and confirm it
 /  Stopwatch OK	Select the submenu and confirm it

Other Useful Features

Network settings

This menu can be used to select mobile telecommunication networks other than your own mobile network provider. However, the corresponding agreements must have been concluded.



It is possible that not all functions described are supported by every provider. Therefore, please contact your local mobile phone provider for details.

Menu

Open the main menu

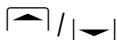

Settings

OK

Select the menu and confirm it

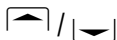

Network settings

OK

Select the submenu and confirm it

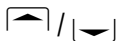

Automatic mode

or

Manual mode

OK







Select the setting and confirm it

Security settings

This menu is used to define which functions on the phone or SIM card should be protected by a password/PIN. The PIN and password can be changed.



PIN and PIN2 are supplied together with the SIM card. Further information is available from your SIM card provider.

Menu	Open the main menu
 /  Settings	OK Select the menu and confirm it
 /  General	OK Select the submenu and confirm it
 /  Security	OK Select the submenu and confirm it

Other Useful Features

PIN protection



The password is supplied together with the SIM card. If you deactivate the SIM lock, you need not enter the PIN after switching the mobile phone on.

It is recommended to leave the SIM lock on to prevent unauthorised persons from using the mobile phone.

Phone lock



The default password programmed at the factory is 0000. If this lock is active, you must first enter the password for the phone lock after switching the mobile phone on and then enter the PIN.

Auto keypad lock

You can set up the mobile phone so that the key lock is automatically activated after a certain time in Standby mode.













Change password

You can change the password to lock the phone against use and altering the default settings. Refer to Menu Structure;  Page 73.

Other Useful Features

Tips

Locking your phone with your own personal PIN. You can lock your mobile phone to prevent unauthorised use by setting up a personal PIN number.

Menu	Open the main menu
 /  Settings	OK Select the menu and confirm it
 /  General	OK Select the submenu and confirm it
 /  Security	OK Select the submenu and confirm it
 /  PIN protection	OK Select the submenu and confirm it
 /  Change PIN1	OK Select the menu and confirm it
Input PIN: 	OK
Input new PIN: 	OK
Input again new PIN: 	OK

Other Useful Features

PIN& PIN2 codes

The **PIN** (**P**ersonal **I**dentify **N**umber) and PIN2 codes are 4 to 8 digit numbers. The PIN and PIN2 codes are given to you, together with the SIM card, by your network provider.





PUK & PUK2 codes

The **PUK** (**P**ersonal **U**nblocking **K**ey) and PUK2 codes are 4 to 8-digit numbers. These are only necessary if you enter the PIN code for the SIM card incorrectly three times in succession and the SIM card is blocked. The PUK and PUK2 codes are given to you, together with the SIM card, by your network provider.

Phone settings

Display settings

Use this menu to adapt the phone display to your own personal needs.

Menu	Open the main menu
 /  Settings	OK
	Select the menu and confirm it
 /  Display	OK
	Select the submenu and confirm it
Select	
Idle display	To select a wallpaper and display the time and date

Other Useful Features

Backlight	To set the length of time the backlight stays on
Background	To select a background colour

Audio settings

Use this menu to adapt the phone's ringing tones to your own personal needs.

Menu	Open the main menu
⬆ / ⬇ Settings	OK Select the menu and confirm it
⬆ / ⬇ Sounds	OK Select the submenu and confirm it

Select

Ringtones	To select specific ringing tones for various alert ringing signals
Volume	To select specific volumes for the various alert ringing signals. Call = Earpiece volume level



Exposure to the receiver at full volume for a long period could cause ear damage.

Other Useful Features

Alert type

To select whether you are alerted of incoming calls via a ringing tone or vibration

Example - Setting the loudest Ringer

The loudest ringer is Ring tone 1 + Volume 7 = 100dB.

Menu

Open the main menu

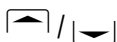

Settings

OK

Select the menu and confirm it

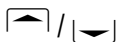

Sounds

OK

Select the submenu and confirm it

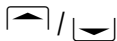

Ringtones

OK

Select the menu and confirm it

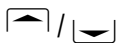

Incoming call

OK

Select the menu and confirm it

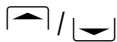

Ring tone 1

OK

Select the ringer and confirm it

Back

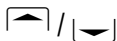





Volume

OK

Select the menu and confirm it

Other Useful Features











-  /  Ring tone  OK
Select the menu and confirm it
-
-   OK
Select the volume and confirm it

Call settings

 It is possible that not all functions described are supported by every provider. Therefore, please contact your local mobile phone provider for details. They may concern services which are subject to charges.

Forwarding calls

The following functions enable incoming calls to be transferred to other phone numbers.

-  Menu  OK
Open the main menu
-
-  /  Settings  OK
Select the menu and confirm it
-
-  /  Call setup  OK
Select the menu and confirm it
-
-  /  Call divert  OK
Select the submenu and confirm it

Select the setting to define which calls should be redirected:

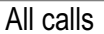
-  All calls

Other Useful Features

If busy

If no reply

If out of reach

OK



and then select

 /  Check status OK

Display the current setting

 /  Activate  OK

Enter the number and activate the call divert function.

 /  Deactivate OK

Deactivate the corresponding call divert function

Call barring

The following function is used to restrict calls which can be received and made.

Menu Open the main menu

 /  Settings OK

Select the menu and confirm it

 /  Call setup OK

Select the menu and confirm it

 /  Call barring OK

Select the menu and confirm it

Other Useful Features

Select the setting for which calls should be restricted:

All outgoing calls

All international calls

Only here & home

All incoming calls

Incoming calls if abroad

OK



The default password is 0000.

Call waiting

This function issues an audible signal to inform you that another call has been received while the current call is in progress.

Menu

Open the main menu

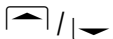

Settings

OK

Select the menu and confirm it

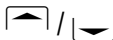

Call setup

OK

Select the menu and confirm it

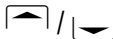

Call waiting

OK

Select the submenu and confirm it

Other Useful Features



Automatic redialling



When this function is activated, redialling is initiated automatically if the number dialled is “engaged”.



Menu Open the main menu

 /  **Settings** **OK**
Select the menu and confirm it

 /  **Call setup** **OK**
Select the menu and confirm it

 /  **Auto redial** **OK**
Select the submenu and confirm it









 /  **Enable** **OK**
Enable the function and confirm it

 /  **Disable** **OK**
Disable the function and confirm it

Other Useful Features

Caller ID

This function is used to activate/deactivate transmission of the phone number, with which you are making the call, with the call.

Menu	Open the main menu
 /  Settings	OK Select the menu and confirm it
 /  Call setup	OK Select the menu and confirm it
 /  Caller ID	OK Select the submenu and confirm it
 /  Set by network	Hide number or Show number
OK	Select a setting and confirm it

Broadcast messages

You mobile phone can receive broadcast messages¹.







Information on broadcast messages, charge rates, data and offers can be obtained from your SIM card service provider.



¹ Broadcast, also referred to as **Cell Broadcast (CB)** = Information services from your telephone network provider

Other Useful Features

Menu Open the main menu

 /  **Message** **OK**
Select the menu and confirm it

 /  **Message settings** **OK**
Select the submenu and confirm it

 /  **Broadcast message** **OK**
Select the submenu and confirm it

Refer to Menu Structure;  Page 69.

Default settings

The mobile phone is reset to its default (factory) settings.

Menu Open the main menu

 /  **Settings** **OK**
Select the menu and confirm it

 /  **Factory default** **OK**
Select the menu and confirm it



During the course of the menu, you will be prompted for the phone password. The default password programmed at the factory is 0000.

11 SIM Tool Kit

This menu contains the SIM Application Toolkit (commonly referred to as STK) of your mobile phone provider. The content and functions available vary from provider to provider and are dependent on the SIM card used.

SIM Application Toolkit (STK) is a GSM system standard which enables the SIM to initiate actions which can be used for various value-added services.





Please contact your local mobile phone provider for details. They may concern services which are subject to charges.

Menu Structure

12 Menu Structure

Main menu

Open the main menu by pressing the **Menu** key. Then press the  /  keys to select a menu option or entry and follow the dialogue in the display using the softkeys which appear.

In this case, the softkeys are assigned different functions, e.g. OK, Go back, Cancel, Options etc.

Softkeys (grey) are only displayed in a few exceptional cases in the following menu structure.

For further information on the menu and operation,  Chapter 4.

Message

Write message



Options

Send

Save

Send to many

Templates

Inbox

OK

Options

Menu Structure

	Reply
	Forward
	Call
	Save number
	Delete
	Delete all
Sent message	
	Refer to Inbox
Drafts	
Templates	
Message settings	
	SMS center number
	Validity period
	Auto save SMS
	Delivery report
	Preferred storage
	SIM
	Phone
	Broadcast message
	Topic

Menu Structure

	Languages
	Receive mode
Storage status	

Contacts

New contact	
	Save to SIM
	Name 
	Number 
	Save to phone
View contacts	
	Options
	View
	Send SMS
	Add to group
	Copy to phone
	Copy to SIM
	Call
	Delete

Menu Structure

View groups	
	Family
	Friends
	Office
	Others
Special numbers	
	My numbers
	Voice mail
Advance	
	M1 M2 M3
	Speed dial
	Choose contacts list
	Copy all
	Delete all contacts
Storage status	

Menu Structure

Calls

Incoming calls	
Call	
Send SMS	
Delete	
Save number	
Delete all	
Show number	
Outgoing calls	
Refer to Incoming calls	
Missed calls	
Refer to Incoming calls	
Call duration	

Tools

Alarm
Calculator
Calendar
Stopwatch

Settings

General	
	Language
	Time and date
	Date & time settings
	Date format
	Date separator
	Time format:
	Answer mode
	Normal answer
	Any key answer
	Security
	PIN protection
	SIM lock
	Change PIN1
	Change PIN2
	Phone lock
	Auto keypad lock
	Change password

Menu Structure

Display		
	Idle display	
	Backlight	
	Background	
Sounds		
	Ringtones	
	Incoming call	
	Message	
	Key tone	
	Volume	
	Call	
	Ring tone	
	Key tone	
	Alert type	
	Ring only	
	Vibrate only	
	Vibrate and ring	
Call setup		
	Call divert	
	All calls	

Menu Structure

	Check status
	Activate
	Deactivate
If busy	
If no reply	
If out of reach	
Call barring	
All outgoing calls	
	Check status
	Activate
	Deactivate
All international calls	
Only here & home	
All incoming calls	
Incoming calls if abroad	
Call waiting	
Auto redial	
Caller ID	
	Set by network
	Hide number

Menu Structure

	Show number
Network settings	
	Automatic mode
	Manual mode
Factory default	

SIM tool kit

(Provider-dependent menu)

13 Trouble Shooting

Service hotline

Should problems arise with the telephone, please refer to the following information first. In the event of technical problems, please contact out service hotline under tel. 0844 800 6503 (Using an UK landline, at the time of going to print: calls cost 6p for connection charge and then 5p a minute. Mobile costs may vary.) In the case of claims under the terms of guarantee, contact your sales outlet. There is a 2 year period of guarantee.

Problems and solutions

Problems	Solutions
The mobile phone cannot be switched on.	<ul style="list-style-type: none">- No battery inserted.- Battery is not loaded.
No signal quality is displayed.	<ul style="list-style-type: none">- No network connection. The mobile phone is in a location where there is no network service. Move to a different location or contact your service provider.

Trouble Shooting

Keypad does not function or only functions very slowly.

- The operating speed of the display is reduced in the case of low temperatures. This is normal. Use the phone in a warmer location.

A message appears in the display for some functions, indicating execution/use is not possible.

- Many functions can only be used after the respective service has been applied for. Contact your service provider for more details.

Screen frozen or no response when pressing keys.

- Remove the battery for 3 minutes and try again.

No connection to the mobile telecommunication network.

- Contact your service provider.

The "Insert SIM" message appears in the display.

- Ensure that the SIM card has been installed correctly. Contact your service provider, if necessary.

Trouble Shooting

The battery cannot be charged or is empty within a short time.

- Battery is defect.
- Place the phone correctly in the charging unit or connect the charging unit properly. Clean the contact surfaces on the mobile phone and charging unit with a soft, dry cloth.
- Charge the mobile for 4 hours.

Tips on the battery

Only use batteries and charging unit approved by the manufacturer, otherwise the battery could be damaged.

Do not short circuit the battery. Always leave the battery in the phone to avoid accidentally short circuiting the battery contacts.

Keep the battery contacts clean and free of dirt.

The battery can be charged/discharged hundreds of times but its service life is limited. Replace the battery when the battery power has decreased noticeably.

Technical Properties

14 Technical Properties

Technical data

Feature	Value
Standard	GSM ¹ 900, 1800 MHz Dualband
Dimensions	52 x 128 x 15 mm (W x H x D)
Weight	92 g incl. battery
Power supply	Input: 100-240 V, 50-60 Hz, 0.15 A Output: Mini-USB 5 V, 500 mA
Battery	3.7 V, 750 mAh Charge duration: Approx. 4 h
Standby time	Up to 150 h
Max. talk time	Up to 120 min
Display	1.75" colour, Resolution 128 x 160
Key lighting	White
LED	Red/Green

¹ **GSM** = **G**lobal **S**ystem for **M**obile
Communications. Standard for mobile phones.

Technical Properties

Languages	German, English, French, Dutch
Phone book	Max. 200 contacts
SMS	Standard SMS Memory capacity: Max. 100 entries (Phone)
Ringing volume	Max. 100 dB
Permissible ambient temperature	-10°C to 40°C
Permissible relative humidity	30% to 75%



All Rights Reserved!

Technical Properties

Default settings

The default settings can be restored via the menu.

Declaration of Conformity

This device fulfils the requirements stipulated in the EU directive:

1999/5/EU directive on radio equipment and telecommunications terminal equipment and the mutual recognition of their conformity.



Conformity with the above mentioned directive is confirmed by the CE mark on the device.

To view the complete Declaration of Conformity, please refer to the free download available on our web site www.amplicomms.eu.

SAR Information

Information on radio frequency emissions and specific absorption rates (**SAR = Specific Absorption Rate**).

All the applicable safety standards related to radio frequency emissions were implemented during the development of this mobile phone. The limit values are based on scientific directives and contain a safety margin in order to guarantee the safety of all persons regardless of age and state of health.

The values specified in the directive concerning radio frequency emissions are based on a unit called SAR. SAR values are established using standard methods in which the phone is operated in all possible frequency bands with the highest power output.

Although the SAR values of various phone models can differ, all the models were developed to maintain the relevant directives on radio frequency emissions. The following information applies to residents of countries which, as with the European Union, have adopted the SAR limit value recommended by the ICNIRP (**I**nternational **C**ommission on **N**on-**I**onizing **R**adiation **P**rotection) which lies at 2W/Kg (averaged from 10 gram tissue): The highest SAR value measured, averaged over 10 g tissue, was < 0.583 W/kg for this mobile phone measured at the ear.

Safety Information

15 Safety Information

Please read this section carefully.



Risk of suffocation!

Keep packaging materials and protective foils out of reach of children.

Intended use

This mobile phone is designed for use when connected to a mobile phone network. Any other use is considered unintended use. Unauthorised modification or reconstruction is not permitted. Under no circumstances open the device or complete any repair work yourself.

Areas of use

- Do **not** use the phone in prohibited areas.
- Switch the phone off in the vicinity of medical equipment (e.g. in hospitals).
- Do not use the phone in petrol stations or near fuels and chemicals.
- Check with the airline whether mobile phones may be used on board.

General information

- Prevent exposure to smoke, dust, vibration, chemicals, moisture, heat and direct sunlight. The phone is not waterproof; therefore, keep it dry.
- Only use the original power supply and batteries. Never attempt to connect other products.
- Repairs to this device may only be completed by qualified service personnel.
- All mobile communication equipment is subject to interference which may impair its performance.
- Keep the phone and accessories out of the reach of children.
- The SIM card can be removed. Caution! Small children can swallow them.
- The ringing tone is issued via the loudspeaker. Take an incoming call first and then hold the phone to your ear.
This prevents any possible hearing damage.
- Only use the phone while driving with the correct handsfree equipment. Ensure that no safety-related functions are interfered with when operating the phone. It is essential to observe the applicable national laws and regulations.

Safety Information

- Always maintain a distance of at least 15 cm to implanted heart pacemakers to prevent any possible interference. If you have had a pacemaker implanted, do not carry the phone in a breast pocket when switched on. Always hold the phone to the ear furthest away from the pacemaker during calls.
Switch the phone off immediately if you notice or suspect any adverse effects.
- Do not rely on the mobile phone as a safeguard for emergencies. For a variety of technical reasons, it is not possible to guarantee a reliable connection under all circumstances.

Power adapter plug



Attention: Only use the power adapter plug supplied because other power supplies could damage the phone. Ensure access to the power adapter plug is not obstructed by furniture or such.



The power adapter plug supplied fulfils the ecodesign requirements of the European Community (Directive 2005/32/EC). This means that the current consumption is considerably less, both in operation as well as in standby, in comparison to older power adapter plug models.

Rechargeable batteries



Attention: Never throw batteries into a fire. Only use batteries of the same type.

Barcode label in the phone

The barcode label contains information on the phone, such as the serial number, for example. Do not remove it.

Safety Information

Disposal

In order to dispose of your device, take it to a collection point provided by your local public waste authorities (e.g. recycling centre). According to laws on the disposal of electronic and electrical devices, owners are obliged to dispose of old **electronic and electrical devices** in a separate waste container. The symbol indicates that the device must not be disposed of in normal domestic waste!



Batteries represent a hazard to health and the environment!



Never open, damage or swallow batteries or allow them to pollute the environment. They may contain toxic, ecologically hazardous heavy metals. You are legally obliged to dispose of power packs and batteries at the point of sale or in the corresponding containers at collection points provided by local public waste authorities. Disposal is free of charge. The symbols indicate that the batteries must not be disposed of in normal domestic waste and that they must be brought to collection points provided by local public waste authorities.

Packaging materials must be disposed of according to local regulations.

16 Maintenance / Guarantee

Maintenance

- Clean the housing surfaces with a soft, fluff-free cloth.
- Do not use any cleaning agents or solvents.

Guarantee

AMPLICOMMS equipment is produced and tested according to the latest production methods. The implementation of carefully chosen materials and highly developed technologies ensure trouble-free functioning and a long service life. The terms of guarantee do not apply when a device malfunction was caused by the mobile telecommunications network operator/provider. The terms of guarantee do not apply to the batteries or power packs used in the products. The period of guarantee is 24 months from the date of purchase.

All deficiencies related to material or manufacturing errors within the period of guarantee will be redressed free of charge. Rights to claims under the terms of guarantee are annulled following tampering by the purchaser or third parties. Damage caused as the result of improper handling or operation, normal wear and tear, incorrect positioning or storage, improper connection or installation or Acts of God and other external influences are excluded from the

Maintenance/ Guarantee

terms of guarantee. In the case of complaints, we reserve the right to repair defect parts, replace them or replace the entire device. Replaced parts or devices become our property. Rights to compensation in the case of damage are excluded where there is no evidence of intent or gross negligence by the manufacturer.

If your device shows signs of defect during the period of guarantee, please return it to the sales outlet in which you purchased the AMPLICOMMS device together with the purchase receipt. All claims under the terms of guarantee in accordance with this agreement can only be asserted at the sales outlet. No claims under the terms of guarantee can be asserted after a period of two years from the date of purchase and hand-over of the product.

17 Index

A

- Alarm, 51
- At a Glance, 4, 16
- Audio settings, 59
- Automatic redialling, 64

B

- Battery charge status, 8
- Battery status warning, 9
- Broadcast messages, 65

C

- Calculator, 52
- Calendar, 53
- Call barring, 62
- Call list, 35, 39
- Call settings, 61
- Call waiting, 63
- Caller identification, 65
- Calling back, 35
- Calling back missed calls, 35
- Charging, 8
- Creating
 - phone book entries, 26, 30

D

- Date, 11, 49
- Declaration of Conformity, 82
- Default settings, 66, 82
- Delete text, 28
- Deleting phone book entries, 30
- Dialling, 35
- Display, 18
- Display icons, 18
- Display language, 11
- Display settings, 58
- Displaying list details, 39
- During a call, 38

E

- Editing phone book entries, 30
- Ending a call, 11, 35
- Energy-save mode, 25
- Entering names, 29
- Entering spaces, 28
- Entering text, 29

F

- Forwarding calls, 61

G

- Getting Started, 24
- Groups, 32
- Guarantee, 89

Index

H

- Handsfree, 36
- Hold, 38
- How does it work, 20
- How to enter
 - text and numbers, 27

I

- Icons, 18

K

- Keypad lock, 37

L

- Language, 50
- Loudest Ringer, 11

M

- Main menu, 68
- Maintenance , 89
- Making a call, 11, 35
- Making and Receiving Calls, 35
- Menu structure, 68
- Methods of entering text, 27
- Modifying
 - phone book entries, 30
- Moving the cursor, 28
- Multitap, 27
- Muting, 37

N

- Network, 10
- Network settings, 54
- Notation, 24

O

- On-hook, 11, 35
- One-touch dialling, 36
- One-touch dialling buttons, 47
- Other Useful Features, 47

P

- Package contents, 6
- Phone book, 35, 38
- Phone Book Set Up, 29
- Phone settings, 58
- PIN/PIN2 code, 58
- Problems, 77
- Problems and solutions, 77
- PUK/PUK2 code, 58
- Punctuation and
 - special characters, 28

Q

- Questions and Answers, 12
- Quick Start Guide, 4

R

- Receiver volume, 36
- Redialling, 35
- Rejecting a call, 11, 35
- Ringtone, 59

S

- Safety information, 84
- SAR Information, 83
- Security settings, 55
- Service-Hotline, 77
- Setting
 - the loudest Ringer, 11, 60
- SIM card, 6
- SIM Tool Kit, 67
- SMS, 40
- SMS settings, 40
- Softkeys, 25
- Sounds, 59, 60
- Speed dial, 48
- Standby mode, 24
- Stopwatch, 53
- Switching off, 10
- Switching on, 10

T

- Taking a call, 11, 35
- Talk time, 36
- Technical data, 80
- Time, 11, 49
- Tips on the battery, 79
- Trouble Shooting, 77
- Turn ringer Off/On, 37

V

- Voice Mail, 45
- Volume, 59

W

- Writing an SMS text, 42

Important Notes on the Guarantee

The period of guarantee for the AMPLICOMMS product begins on the date of purchase. Rights to claims under the terms of guarantee relate to deficiencies resulting from material or production faults. Rights to claims under the terms of guarantee are annulled following intervention by the purchaser or third parties. Damage caused as a result of improper handling or operation, normal wear and tear, incorrect positioning or storing, improper connection or installation, Acts of God or other external influence are not covered by the terms of guarantee.

CLAIMS UNDER THE TERMS OF GUARANTEE MAY ONLY BE ASSERTED TO THE RETAILER WHERE THE EQUIPMENT WAS PURCHASED, WHEREBY THE PURCHASE RECEIPT MUST ALSO BE SUBMITTED.

TO PREVENT UNNECESSARY LONG DELAYS, PLEASE DO NOT SEND EQUIPMENT UNDER COMPLAINT TO OUR OFFICE ADDRESS.

IN THE CASE OF QUESTIONS CONCERNING OPERATION OR THE TERMS OF GUARANTEE, PLEASE REFER TO THE OPERATING MANUAL OR CONTACT OUR HOTLINE:

0844 800 6503 (Using an UK landline, at the time of going to print: calls cost 6p for connection charge and then 5p a minute. Mobile costs may vary.)

AUDIOLINE GmbH

Neuss

Internet: www.amplicomms.eu - E-mail: info@audioline.de