



Mobile Phone



Operating Instructions

PowerTel M6000

HAC Hearing Aid Compatible to M4 / T4 Rating

The M6000 Phone has a built in Induction Coil and is hearing aid compatible.

To ensure optimum benefit, users with hearing aids may wish to select the T setting on their hearing aids.



Exposure to the receiver at full volume for a long period could cause ear damage.

Contents

1	Quick Start Guide	4
2	At a Glance	16
3	How does it work	20
4	Getting Started	24
5	Phone Book Set Up	30
6	Making and Receiving Calls	34
7	Call Lists	38
8	SMS - Text Messages	40
9	Voice Mail	46
10	Other Useful Features	48
11	Bluetooth	72
12	Emergency Call Function	74
13	Services	83
14	Menu Structure	84
15	Trouble Shooting	98
16	Technical Properties	101
17	Safety Information	104
18	Maintenance / Guarantee	109
19	Index	111

Quick Start Guide

1 Quick Start Guide



Important: Before you start, please read the safety information on page 104.

Quick Glance

- 1 Earpiece
- 2 Display
- 3 One-touch dialling keys / Softkeys
- 4 On/Off key / End call key
- 5 Scroll up/down keys
- 6 Hash key
- 7 Microphone
- 8 Star key
- 9 Keypad
- 10 Call key
- 11 LED
- 12 Attachment for Lanyard (not supplied)
- 13 Mini USB charging socket
- 14 Charge contacts
- 15 Headset socket (Headset not supplied)
- 16 Volume control
- 17 Loudspeaker
- 18 Emergency call switch
- 19 Battery compartment cover

Quick Start Guide

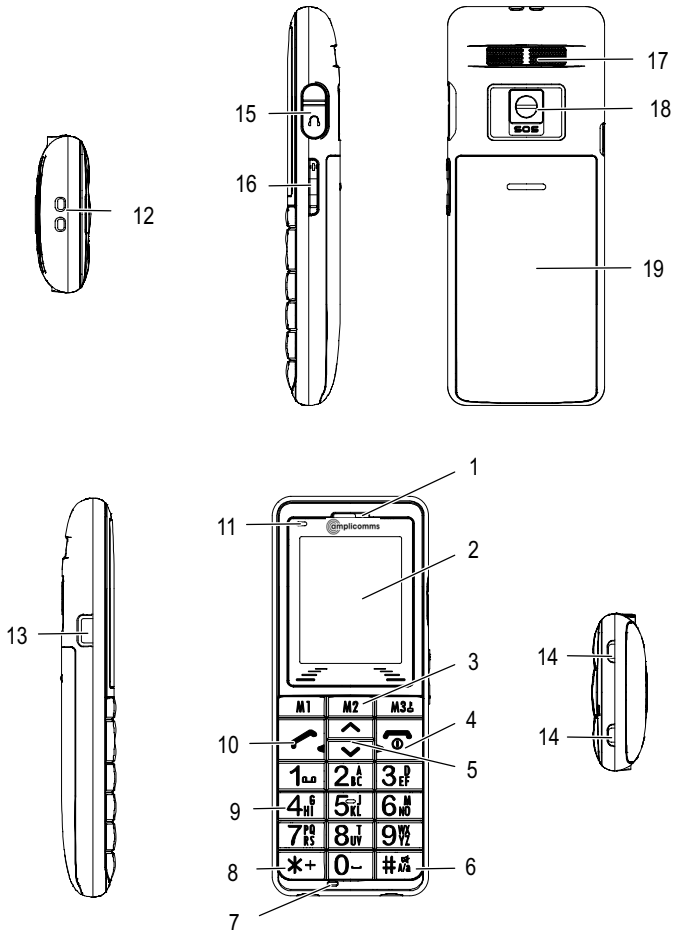

Quick Start Guide

What is in the box

The box contains:

- | | |
|-------------------------|----------------------|
| 1 mobile phone | 1 power adapter plug |
| 1 li-ion battery | 1 operating manual |
| 1 desktop charging unit | |

Installing the SIM card and battery



Risk of swallowing small objects!
The SIM card can be removed.
Small children can swallow them.

Switch the phone off.



Pay attention that the SIM card is not bent or scratched. Prevent any contact with water, dirt or electrical charges.

Slide the mobile phone's battery compartment cover towards the bottom using a little force. Lift the battery compartment cover off the phone completely.



Your telephone number is carried by the SIM card, not the phone. Therefore if you use a SIM card you had in a previous phone, you will keep the same phone number.

Quick Start Guide

If there is already a battery inside, remove it.



Slide the SIM card with the golden contacts facing down in the moulded SIM card holder. The SIM card must be located under the metal retaining bar to be in the correct position.



Insert the battery. The golden contacts on the battery must face towards the bottom right. Press lightly on the top end of the battery until it snaps into place.

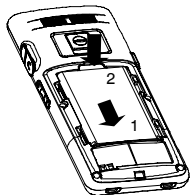

Replace the battery compartment cover back on the phone. Slide the battery compartment cover upwards until it snaps in to place.

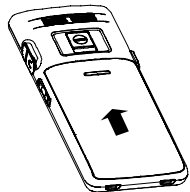

Quick Start Guide

Charging the battery



Before starting to charge the battery, check that it has been installed properly.

Do not remove the battery while it is being charged. This could damage the phone.



When charging the battery for the first time, it should be charged for **at least** 4 hours. Some batteries only reach their full capacity after several complete charge/discharge cycles.

Charging via the mini USB charging socket

Plug the power adapter in the mini USB charging socket.

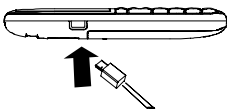

Connect the power adapter plug as illustrated in the diagram. For safety reasons, only use the power adapter plug supplied.

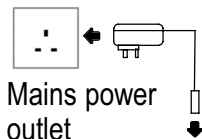



Quick Start Guide

Charging via the desktop charging unit

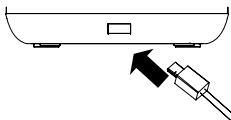
Plug the power adapter plug in the mini USB charging socket on the charging unit. Insert the phone in the charging unit to charge it.



 The display will go blank but even so the battery is still being charged. This is correct operation.

 It may take a few seconds before the phone indicates the charging process. You can use the phone during the charging process.

When the phone is switched off there is a different view in the display - the charge icon is shown pumping with the red LED.

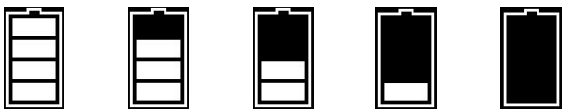

Battery status warning

The current **battery charge status** is indicated in the display as follows:



Full



Half empty



Low



Empty

Quick Start Guide

When the battery charge is low, a corresponding warning message appears in the display.

 Charge the battery.

In cases where the battery charge is extremely low, it is possible that the back-lighting no longer works and certain functions are no longer available.

 Charge the battery.

When the battery charge drops below the minimum status, the phone switches off automatically.

Switching the mobile phone on and off

3 sec.  Switch the mobile phone on

3 sec.  Switch the mobile phone off

 Some SIM cards will require you to enter a PIN code. Follow the prompts on the screen or read more details about PIN & PIN2 on Page 59.

Make sure you are in range of your Network

Some networks offer better coverage than others in different areas. The icon  indicates you have a signal and are connected to the network. The network will also appear in the display.

Setting the display language

If you want to select a different language please refer to Page 51.

The following languages are available: German, English, French, Spanish, Italian, Dutch, Portuguese, Swedish, Danish, Norwegian, Finnish and Turkish.

Setting the time and date

Refer to Page 50.

Setting the loudest Ringer

Refer to Page 61.

Now you are ready to make and receive calls.

Taking a call



Take the call

Rejecting a call



Reject the call

Ending a call



End the call

Making a call



Enter the phone number



Delete the last digit if incorrect





Dial the phone number

Quick Start Guide

Advanced Settings and Functions

For more details about setting up your Amplicomms M6000 and other functions follow the descriptions in this user guide.

Examples;

- Set your one-touch dialling M1 / M2 / M3 keys;  Page 48.
- Store numbers in the phone book;  Page 27.
- Use the Index;  Page 111.



If you have any questions please call the Service-Hotline: 0844 800 6503 (Using an UK landline, at the time of going to print: calls cost 6p for connection charge and then 5p a minute. Mobile costs may vary.)

Questions and Answers



In the majority of cases your M6000 phone is supplied without a SIM card. You may find the following “**Questions and Answers**” (Q & A) helpful.

Q - Why hasn't the mobile phone been supplied with a SIM card?

A - Many people already have a mobile phone and wish to transfer their existing SIM card over to the new phone. This has the advantage of keeping the same telephone number and if the card is subscribed to a Pay-as-you-go service then you also benefit

Quick Start Guide

from being able to carry over any credit that has been paid the card.

Q - Where can I get a SIM card from?

A - Any high street mobile phone shop will be able to provide you with a SIM card. Some of the major supermarket chains also provide mobile phone services and can supply a SIM card. A useful tip when choosing a SIM card / service provider however is to make sure that you have adequate signal coverage at home; this particularly important if you live in a very rural area.

Q - Why doesn't the Amplicomms mobile phone have a telephone number?

A - The telephone number is supplied by the service provider and will be registered onto the SIM card.

Q - Can I use the SIM card from my old mobile phone?

A - Yes as long as the SIM card is less than three years old you can transfer the card over. Some old SIM cards however are not compatible with the Amplicomms mobile phone as they are from an earlier generation of SIM card design.

Q - Can I use a SIM card from any mobile phone company?

Quick Start Guide

A - Yes. The Amplicomms mobile phone is what is termed as an open SIM card phone and so it is not restricted to any particular service provider or mobile phone company.

Q - How do I pay for my calls?

A - There are two main types of registration with a service provider or mobile phone company. One is a contract - this is where you sign up for agreed contract over several months / year and pay an agreed monthly fee. This is more suited to people who are using their mobile phone as part of their job for example. The other is Pay-as-you-go, sometimes abbreviated to PAYG. With this type of service you add credit to the card and top up as and when required. Topping up the card is easy, you can do this over the phone, on-line, at many shops and even some cash points allow you to do this. PAYG is more suited to less frequent users.

Q - How do I find out my credit balance?

A - The service provider of the SIM card should have provided an information pack with the card. This will give details of a short number to dial in order to check your balance. These access codes differ between mobile phone companies so please check the details specific to your service provider. Key in your number, press the talk button and the credit balance will be announced to you.

Notes

At a Glance

2 At a Glance

Keys and Parts

- 1 Earpiece
- 2 Display
- 3 One-touch dialling keys / Softkeys
- 4 On/Off key / End call key
- 5 Scroll up/down keys
- 6 Hash key
- 7 Microphone
- 8 Star key
- 9 Keypad
- 10 Call key
- 11 LED
- 12 Attachment for Lanyard (not supplied)
- 13 Mini USB charging socket
- 14 Charge contacts
- 15 Headset socket (Headset not supplied)
- 16 Volume control
- 17 Loudspeaker
- 18 Emergency call switch
- 19 Battery compartment cover





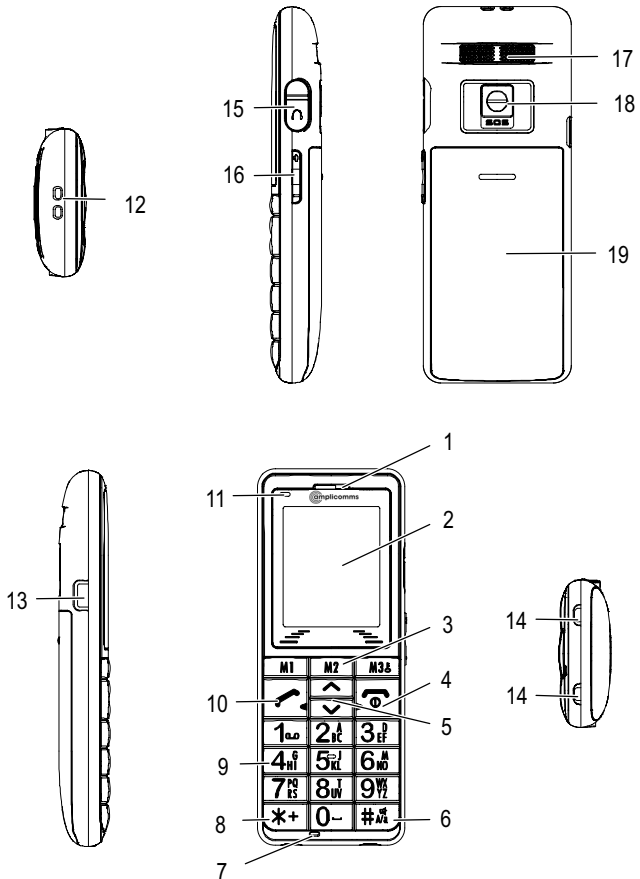







The keys in this operating manual are subsequently depicted with a uniform contour. Therefore, slight deviations in the appearance of the symbols on the mobile phone keys compared to those depicted here are possible.

At a Glance













At a Glance

Icons and texts in the handset display

Icon	Description
	Displays the battery capacity. Running-through segments, the battery is being charged.
	Signal strength of the phone's connection
	Alarm is activated
	The key lock function is activated;  Page 36
	A roaming ¹ call is in progress
	A headset is connected
	There are new calls in the call list;  Page 38
	The microphone is deactivated (muted);  Page 36
	Call forwarding is active

¹ Cost of roaming calls and SMS will vary considerably from country to country. Check with your Operator.

At a Glance

	A new SMS ¹ text message has been received;  Page 40
	SMS text memory is full;  Page 45
	Ringtone only is activated
	Vibration alert only is activated / Silent mode activated
	Vibration alert and ringtone are activated or first the vibration alert then ringtone is activated
	Bluetooth ^{® 2} is activated
	The volume is set high and care should be taken when using the phone.
	"Fall Down" is switched on;  Page 78

¹ **SMS: Short Message Service** = Service for sending text messages.

² Bluetooth[®]: Industrial standard for communication between devices over short distances.

How does it work

3 How does it work

1 Earpiece



The voice of the caller can be heard here when no headset is being worn or the handsfree equipment has not been installed and activated and the device not set to Handsfree mode.

2 Display

The information which appears in the display guides you through the menu structure and helps operate the mobile phone

3 One-touch dialling keys / Softkeys







A phone number can be assigned to each one-touch dialling key and then dialled directly by pressing and holding the respective key.

  are also softkeys.

The softkeys are assigned different functions in the various menus. The current function is always indicated by a text directly above the key in the display.

 = Initiate key lock

How does it work



- | | | | |
|----|---|--------------------------|---|
| 4 |  | On/Off key, End call key | Switch the mobile phone on and off
Cancel the current process
End or reject a call
Scroll to the right |
| 5 |  | Scroll up / down | Navigate in the menus |
| 6 |  | Hash key | Switch ringing tone on/off,
Switch upper/lower case,
Key lock |
| 7 | | Microphone | Is activated during a call |
| 8 |  | Star key | Enter special characters |
| 9 |  | Keypad | Enter phone numbers and names or write a text |
| 10 |  | Call key | Take a call or dial a number
Open the call list
Scroll to the left |
| 11 | | LED | Indicates the phone operating status. The LED will stay on while charging and will flash if no signal is detected or no network to be clamp on to alert the user. |
| 12 | | Attachment eye | Attachment for Lanyard (not supplied) |

How does it work

13 Mini USB charging socket
To connect the USB charger

14 Charging contacts The phone is charged via these contacts when in the charging unit

15  Headset socket (Headset not supplied)
Connect a headset.
The earpiece, loudspeaker and microphone are deactivated. You can only hear and speak via the headset.

16   Volume control
Regulates the volume of the caller

17 Loudspeaker You can hear the caller's voice from here when the phone is in Handsfree mode

18  Emergency call switch
Activate emergency call (SOS)

19 Battery compartment cover
Cover of the battery compartment

Special Functions Keys

Mode	Hold 
Standby	Switched ringer Off / On - Silent Mode

Hold 

A connection is established to your mailbox and you can play messages recorded;  Page 46.

Getting Started

4 Getting Started

This chapter provides basic information on using the operating instruction manual and the telephone.

Description of operating sequences in the manual

Display	Description
	Press the key depicted briefly
2 sec.	Press the key depicted for 2 seconds
Hold	Press and hold down the key depicted
	Enter numbers or letters
	Mobile phone rings
	Remove the phone from the charging unit
	Place the phone in the charging unit
	Represents text in the display
E.g.	Indicates icons in the display
	Press the softkey; Page 25



Standby mode

All descriptions in this operating manual assume that the mobile phone is in Standby mode. The system switches to Standby mode by pressing the  key, several times if necessary. It may be necessary to deactivate the key lock function.



Energy-save mode

When the phone has been in Standby mode for some time, it automatically switches to energy-save mode. The display no longer lights up. Press any key to reactivate Standby mode.

Softkeys

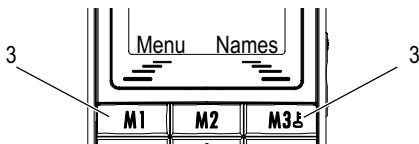
The softkeys  (3) and  (3) are assigned different functions in the different menus. The softkeys are always referred to in this manual according to the texts directly above them in the display.















Key	In Standby mode	In a menu
	- Open the main menu	- Various functions
	- Open the phone book - Activate the key lock	- Various functions

Getting Started



Navigating in the menu

All the functions can be accessed via the various menus. Refer to Menu Structure,  Page 84, for information on how to access each respective function.

Menu ()	Open the main menu
 / 	Select the submenu required
OK ()	Open the submenu
 / 	Select the function required
OK	Open the function
 /  OK	Select the setting required
	Use the keypad to enter numbers or letters
 (softkey)	Confirm the entries
 (softkey)	Move one level back
	Cancel the programming and saving processes and return to Standby mode

Creating phone book entries - example

The way in which to navigate through the menus and define settings is explained by means of the example **Creating phone book entries**. Proceed as in this example for all the settings.

Menu	Open the main menu
<input type="button" value="^"/> / <input type="button" value="v"/> Phonebook <input type="button" value="OK"/>	Select "Phonebook" and confirm it
<input type="button" value="^"/> / <input type="button" value="v"/> Add new contact <input type="button" value="OK"/>	Select the submenu and confirm it
<input type="button" value="^"/> / <input type="button" value="v"/> To SIM or To phone <input type="button" value="OK"/>	Select the memory location and confirm it
Name <input type="button" value="OK"/>  <input type="button" value="OK"/>	Open Edit mode, enter the name and confirm it
<input type="button" value="^"/> / <input type="button" value="v"/> Number  <input type="button" value="OK"/>	Open Edit mode, enter the number and confirm it
Save? <input type="button" value="Yes"/> or <input type="button" value="No"/>	Save or reject the entry

Getting Started

How to enter text and numbers

The keypad is also labelled with letters for the entry of text.

The phone provides various methods by which text can be entered. These are used when creating or editing contacts in the phone book, when searching for names in the phone book and when writing SMS text messages.



Not every method is always available for each application.

Entering Text

Multitap

In order to enter text in Multitap mode, press the key labelled with the corresponding letter/character. If the first character of the group is required, press the key once. If the second character is required, press it twice, and so on.



To enter two characters assigned to the same key, press the key the respective number of times to enter the first character. Then wait for approx. 2 sec. and enter the second letter.





Getting Started

ABC	Multitap upper case
abc	Multitap lower case
123	Numbers



To switch between the text and numbers, press the  key.



Punctuation and special characters

When entering text, press the  key. Punctuation marks and special characters are displayed. Use the  /  keys to select the required character and insert it by pressing the **OK** softkey. To enter a space, press the  key.

Phone Book Set Up

5 Phone Book Set Up

The phone book in the phone can store up to 500 entries.

- Always enter the area code with all the phone numbers.
- When the memory capacity is used up, the corresponding message appears when an attempt is made to store another entry. Before new entries can be stored, old entries must be deleted.
- The phone book entries are arranged alphabetically. To skip directly to a required phone book entry, press the corresponding first letter. To search for the entries manually, use the  /  keys.







Your provider can state how many entries you can store on your SIM card.

Phone Book Set Up

Entering names















The keypad is also labelled with letters for the entry of names. Press the corresponding key the respective number of times to enter letters. Information on ways of entering text;  Page 28.

	Enter a space
	Delete
 / 	Move the cursor to left or right

Creating phone book entries

Refer to Page 27.

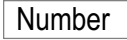
Saving in Standby mode

	Enter the phone number
	Open the menu
 /   or  	Select the memory location and confirm it
   	Open Edit mode, enter the name and confirm it
 /    	Open Edit mode, edit the number and confirm it

Phone Book Set Up

Save? Yes or No

Save or reject the entry

Modifying, editing, deleting phone book entries

Names

Open the phone book

Search for the required entry as described at the beginning of this chapter.

OK

Open the menu

The following functions can also be used:

Call

Dial the entry

View

View the entry

Edit

Edit the entry

Delete

Delete the entry

Copy

Copy the entry
(SIM ↔ phone)

Move

Move the entry
(SIM ↔ phone)

Execute the functions and then confirm them.

Editing or deleting all entries

Menu

Open the main menu

⏪ / ⏩

Phonebook

OK

Select "Phonebook" and confirm it

Phone Book Set Up

The following functions can also be used:

<input type="text" value="Copy all"/>	Copy all the entries (SIM or phone)
<input type="text" value="Delete all"/>	Delete all the entries (SIM or phone)

Execute the functions and then confirm them.

Settings

<input type="text" value="Menu"/>	Open the main menu
<input type="text" value="⤴ / ⤵ Phonebook"/> <input type="text" value="OK"/>	Select "Phonebook" and confirm it
<input type="text" value="⤴ / ⤵ Phonebook settings"/> <input type="text" value="OK"/>	Select the menu and confirm it

The following functions are available

<input type="text" value="Extra numbers"/>	View the additional numbers (e.g. own phone number)
<input type="text" value="Memory status"/>	The status of the SIM and phone memory is displayed
<input type="text" value="Preferred storage"/>	Select your preferred storage medium (SIM or phone)

Making and Receiving Calls

6 Making and Receiving Calls

Taking a call

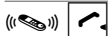

Take the call

Rejecting a call



Reject the call

Ending a call



End the call

Making a call



Enter the phone number

Clear

Delete the last digit if incorrect



Dial the phone number

Call list

Your mobile phone stores the last phone numbers dialled (**redialling**), calls **received** and **missed calls** in a call list.



Open the calls list

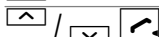

Select the entry and dial it

Dialling numbers from the phone book

Phone numbers must have been stored in the phone book for this function;  Page 27.

Names

Open the phone book

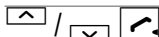

Select the entry and dial it

Making and Receiving Calls

One-touch dialling keys

You must have already assigned phone numbers to the one-touch keys;  Page 48.

3 sec. , or

Press the key

Setting the receiver volume

The volume can be adjusted during a call.

or

Select the required volume



Exposure to the receiver at full volume for a long period could cause ear damage.

Talk time display

The duration of a call is displayed in hours, minutes and seconds during the call.

Handsfree

This function is used to listen to the caller via the loudspeaker.



Activate the handsfree facility

Deactivate the handsfree facility

Making and Receiving Calls

Muting the microphone in the handset

The microphone in the handset can be activated and deactivated during a telephone conversation.



Options	Open the menu
 /  Mute	
On	Deactivate the microphone (muting function activated)
Off	Activate the microphone

Keypad lock

The keypad lock is intended to prevent functions being triggered unintentionally.

 and then  immediately
Activates the key lock function

 Calls can still be taken in the normal way even when the key lock function is activated.

 and then  immediately
Deactivates the key lock function

Turn ringer Off/On

The ringer can be set to silent - vibrate only.

3 sec.  Switch the ringer off

3 sec.  Switch the ringer on

When you have set the ringer "Off" you will notice this icon  in the display.

Making and Receiving Calls



Options during a call

Options

Open the “Options” menu

This menu provides access to functions which can be executed during a call:

Hold

 /  Hold single call OK

Put the current call on hold



When a call is put on hold, the menu option changes to “Retrieve single call”.

To retrieve the call put on hold

 /  Retrieve single call OK

Resume the call

New call

 /  New call OK

Select the function





Enter the phone number and dial it



The first call is put on hold.

Phone book

 /  Phonebook OK

Open the phone book

Muting function

 /  Mute On

Call Lists

7 Call Lists

The mobile phone is equipped with a calls list. Your mobile stores the last phone numbers dialled, taken and received but missed.



If one of the phone numbers received matches an entry in the phone book, the associated name appears.

The following icons appear to indicate

numbers dialled

calls received

missed calls

Dialling from the calls list



Open the calls list

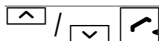

Select an entry and dial it

Displaying list details

Open the calls list.

/ **OK** Select an entry and display details

Options Open the Options menu

The following functions are available:

Delete Delete the entry

Save to Phonebook Save the entry (SIM or phone)

Call Dial the entry

Send text message Send the text message

Execute the functions and then confirm them.

SMS - Text Messages

8 SMS - Text Messages



It is possible that not all functions described are supported by every network. Therefore, please contact your local mobile phone provider for details.

SMS settings



Text messages are distributed via a Service Centre. If you want to send and receive SMS text messages, you must program a service centre number in your mobile phone. Normally, this has already been set up by your service provider.

Navigate to the “SMS settings” menu.

Menu

Open the main menu



Messages

OK

Select the menu and confirm it



SMS settings

OK

Select the menu and confirm it

SMS - Text Messages

Profile settings

Navigate to the “SMS settings” menu.

/ Profile settings

Select the menu and confirm it

/ Profile 1 or Profile 2

Select a profile and confirm it

The following functions are available:

Edit the profile name

Edit the SMS Service Center number

Define the period of validity

You can use this feature to define how long an attempt should be made to deliver a message which you have sent.

Set the type of message

Execute the functions and then confirm them.

SMS - Text Messages

General settings



Delivery report

Select “Delivery report - On” to receive the corresponding delivery confirmation report that a message sent has been received.

Reply path

Select “Reply path - On” to send the reply path of your provider with an SMS message. Contact your provider for further details.

Navigate to the “SMS settings” menu.

 /  Common settings 



Select the menu and confirm it

 Switch on or off

 Switch on or off

Memory status

Navigate to the “SMS settings” menu.

 /  Memory status 

Select the menu and confirm it



The memory locations occupied and free on the both the mobile phone and SIM card are displayed.

SMS - Text Messages

Writing an SMS text



A text message can contain up to 457 characters, including spaces. A standard message contains 160 characters. Additional costs may ensue in the case of messages containing more than 160 characters.

Menu

Open the main menu



Messages

OK

Select the menu and confirm it



Write message

OK

Select the menu and confirm it



Write the text.



Information on ways of entering text;
Page 28.

Options

Open the menu

Insert templates

OK

Done

OK

The following functions are available

Send only

OK



or Search

Enter the number or select from the phone book.

SMS - Text Messages

Save and send

OK

Enter the number or select from the phone book. The SMS text is saved in the “Outbox” folder and sent to the number dialled.

Save

OK

The SMS text is saved in the “Outbox” folder.

Send to many

OK

The message can be sent to several recipients selected from the phone book.

Execute the functions and then confirm them.

SMS text messages sent and received



Texts received are indicated by a ringing tone which you have set. A message appears in the display. Press the “Read” softkey to display the message.

SMS texts received are stored in the “Inbox” folder. SMS texts sent are saved in the “Outbox” folder as are the drafts.

SMS - Text Messages

Editing stored texts

Menu	Open the main menu
<input type="button" value="^"/> / <input type="button" value="v"/> Messages	<input type="button" value="OK"/>
Select the menu and confirm it	
<input type="button" value="^"/> / <input type="button" value="v"/> Inbox / <input type="button" value="v"/> Outbox	<input type="button" value="OK"/>
Select the menu and confirm it	
<input type="button" value="^"/> / <input type="button" value="v"/> OK	Select SMS and confirm it
Options	Open the menu

The following functions are available:

<input type="button" value="Reply"/>	Reply to the number from which the text was sent
<input type="button" value="Delete"/>	Delete the SMS text
<input type="button" value="Forward"/>	Forward the text to a different number
<input type="button" value="Copy to phone"/> / <input type="button" value="Copy to SIM"/>	Copy the SMS text
<input type="button" value="Move to phone"/> / <input type="button" value="Move to SIM"/>	Move the SMS text
<input type="button" value="Use number"/>	Use the number from which the text was sent

Execute the functions and then confirm them.

Voice Mail

9 Voice Mail



It is possible that not all functions described are supported by every provider. Therefore, please contact your local mobile phone provider for details. They may concern services which are subject to charges.

In order to use the “Voice Mail”¹ feature, the relevant phone number must be programmed in your mobile phone. Normally, this has already been set up by your service provider.

Setting up the Voice Mail feature

Menu	Open the main menu
/ Messages	OK Select the menu and confirm it
/ Voicemail server	OK Select the menu and confirm it
/ <Empty>	Options Select a Voicemail server and open options
/ Edit	OK Select the menu and start editing

¹ Voice Mail, also referred to as mailbox (answering machine in mobile telecommunication network)

Voice Mail

/

Open Edit mode, enter the name and confirm it

/

Open Edit mode, edit the number and confirm it

, or

Confirm or cancel changes

The following function is also available in the “Voicemail server” option.

The Voice Mail number is dialled

Execute the functions and then confirm them.

Playing the Voice Mail messages

Navigate to the “Call voicemail” menu option, as previously described, and press the softkey or Hold

A connection is established to your “Voice Mail” and you can play messages recorded.

Other Useful Features







10 Other Useful Features

One-touch dialling keys

It is possible to assign phone numbers to the one-touch dialling keys **M1**, **M2** or **M3** which are then dialled directly by pressing and holding the corresponding key;  Page 35.

 Each number you want to define as a one-touch dialling number must be stored in the phone book.

Assigning a phone number to a one-touch dialling key:

Menu	Open the main menu
 /  Phonebook OK	Select the menu and confirm it
 /  Set M1/M2/M3 OK	Select the menu and confirm it
 /  <input type="text"/> Edit	Select the one-touch dialling key and confirm it
Select	
<input type="text"/> View	To display the number
<input type="text"/> Change	To edit a phone number in the phone book

Other Useful Features

Delete

To delete the number assigned

Execute the functions and then confirm them.

Speed dialling

Phone numbers can be assigned to the keypad to . Then hold the corresponding key pressed longer than 3 seconds to dial the corresponding number.



Each number you want to define as a speed dial number must be stored in the phone book.

Menu

Open the main menu

/ Phonebook

Select the menu and confirm it

/ Speed dial

Select the menu and confirm it

/ Status

Activate speed dialling

/ Set number

Select the menu and confirm it

/

Select the required key and confirm it

/











Select an entry and confirm it

Other Useful Features



Time and date



This menu option can be used to set and change the date and time.

Open the main menu:

Menu		Open the main menu
 / 	Settings	OK
		Select the menu and confirm it
 / 	Phone settings	OK
		Select the menu and confirm it
 / 	Time and date	OK
		Select the menu and confirm it
 / 	Set time/date	OK
		Select the menu and confirm it
HH:MM	 	Enter hours:minutes and jump to date
DD/MM/YYYY	 OK	Enter day:month:year and confirm it
 / 	Set format	OK
		Select the menu and confirm it
Time	 /  , 	Select "12" or "24" and jump to Date

Other Useful Features

Date  / ,  Select “MM DD YYYY”, “YYYY MM DD” or “DD MM YYYY” and jump to Date separator



Date separator  / , **OK**
Select “.” “:” “/” or “-” and confirm it



Language



This menu option can be used to set and change the display language.



Open the main menu:

Menu Open the main menu

 /  **Settings** **OK**
Select the menu and confirm it





 /  **Phone settings** **OK**
Select the menu and confirm it

 /  **Language** **OK**
Select the menu and confirm it





 /  **OK**
Select your preferred language and confirm it

Other Useful Features

Calendar

This menu option opens the calendar. You can select other days. Use the  /  and  /  keys to navigate.









Open the Calendar:

Menu	Open the main menu
 /  Extra	OK
	Select the menu and confirm it
 /  Calendar	OK
	Select the menu and confirm it



Alarm

This menu option can be used to programme 5 different alarms.



Open the Alarm:

Menu	Open the main menu
 /  Extra	OK
	Select the menu and confirm it
 /  Alarm	OK
	Select the menu and confirm it
 /  00:00	Edit
	Select one Alarm and open Edit mode
Off  /  , 	Select "On" or "Off" and jump down

Other Useful Features

00:00  

Enter hours:minutes and jump to Repeat

Repeat  / , 

Select “Once”, “Everyday” or “Custom” and jump to Snooze

If you select Custom:

SMTWTFS  / 

Select a day

S = Sunday, **M** = Monday, **T** = Tuesday, **W** = Wednesday, **T** = Thursday, **F** = Friday, **S** = Saturday

On or Off



Select whether the alarm is active or not this day

Configure the other days for your preferred situation.

 Active days are highlighted with a frame.



Jump to Snooze

Snooze (min)  / , 

Select between “1” to “10” minutes and jump to Alert type

Alert type  / , Done

Select “Vib. and ring”, “Ring only” or “Vib. only” and confirm it

Save?, Yes or No

Confirm or cancel changes

Other Useful Features

Calculator

This feature provides a simple calculator feature with which to solve simple basic calculations.

Use the \square^{\wedge} and \square^{\vee} keys to select the required arithmetic operation (+, -, x, \div).

Use the $\square^{\#.}$ key to set a decimal point.

Use the \square^{*+} key to change the sign (\pm).

Menu

Open the main menu

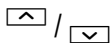

Extra

OK

Select the menu and confirm it

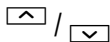

Calculator

OK

Select the menu and confirm it

Example

To execute the calculation “-5 x 2.5 “ you have to type the following keys;

$\square^{5_{kl}}$ \square^{*+} = -5

\square^{\wedge} \square^{\wedge} \square^{\wedge} = x

$\square^{2_{kl}}$ $\square^{\#.}$ $\square^{5_{kl}}$ = 2.5

OK = -12.5

Clear = Delete

Other Useful Features

Tone Control

Users of hearing aids and non users will appreciate this unique feature. The Phone is delivered with the Tone Control set in the normal position and there are two additional options available;

- Low Frequency setting
- High Frequency setting

Menu	Open the main menu
------	--------------------

<input type="button" value="^"/> / <input type="button" value="v"/>	Settings	<input type="button" value="OK"/>
---	----------	-----------------------------------

Select the menu and confirm it

<input type="button" value="^"/> / <input type="button" value="v"/>	Tone control	<input type="button" value="OK"/>
---	--------------	-----------------------------------

Select the menu and confirm it

<input type="button" value="^"/> / <input type="button" value="v"/>	Normal	, <input type="button" value="Low frequency"/> or
---	--------	---

<input type="button" value="High frequency"/>	<input type="button" value="OK"/>
---	-----------------------------------



Select a setting and confirm it

Select your preferred frequency that provides the best hearing experience.

Other Useful Features

Network settings

Network selection: This menu can be used to select mobile telecommunication networks other than your own mobile network provider. However, the corresponding agreements must have been concluded.

Preferences: You can select and edit the mobile telecommunication networks prescribed on the SIM card. Use the  /  keys to change the priority.



It is possible that not all functions described are supported by every provider. Therefore, please contact your local mobile phone provider for details.

Menu

Open the main menu



Settings

OK

Select the menu and confirm it



Network settings

OK

Select the menu and confirm it

Network selection

or

Preferences

Refer to Menu Structure;  Page 93.

Security settings

This menu is used to define which functions on the phone or SIM card should be protected by a password/PIN. The PIN and password can be changed.



PIN and PIN2 are supplied together with the SIM card. Further information is available from your SIM card service provider.

Menu

Open the main menu



Settings

OK

Select the menu and confirm it



Security settings

OK

Select the menu and confirm it

SIM lock



The PIN is supplied together with the SIM card. If you deactivate the SIM lock, you need not enter the PIN after switching the mobile phone on.

It is recommended to leave the SIM lock on to prevent unauthorised persons from using the mobile phone.

Other Useful Features

Phone lock



The default setting for the password is 1234. If this lock is active, you must first enter the password for the phone lock after switching the mobile phone on and then enter the PIN.

Change password

Change the passwords/PIN
Refer to Menu Structure; Page 94.

Tips

Locking your phone with your own personal PIN. You can lock your mobile phone to prevent unauthorised use by setting up a personal PIN number.

Menu

Open the main menu

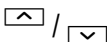

Settings

OK

Select the menu and confirm it

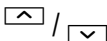

Security settings

OK

Select the menu and confirm it

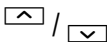

Change password

OK

Select the menu and confirm it

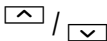

PIN

OK

Select the menu and confirm it

Input old PIN



OK

New PIN



OK

Input again



OK

Other Useful Features

PIN & PIN2 codes

The **PIN** (**P**ersonal **I**dentify **N**umber) and PIN2 codes are 4 to 8-digit numbers. The PIN and PIN2 codes are given to you, together with the SIM card, by your network provider.

PUK & PUK2 codes

The **PUK** (**P**ersonal **U**nblocking **K**ey) and PUK2 codes are 4 to 8-digit numbers. These are only necessary if you enter the PIN code for the SIM card incorrectly three times in succession and the SIM card is blocked. The PUK and PUK2 codes are given to you, together with the SIM card, by your network provider.

Phone settings

Navigating to the “Phone settings” menu.



Menu	Open the main menu
<input type="button" value="^"/> / <input type="button" value="v"/> Settings	<input type="button" value="OK"/>
	Select the menu and confirm it
<input type="button" value="^"/> / <input type="button" value="v"/> Phone settings	<input type="button" value="OK"/>
	Select the menu and confirm it

Display settings

Use this menu to adapt the phone display to your own personal needs.

Navigate to the “Phone settings” menu.

Other Useful Features

 /  **Display characteristics** **OK**
Select the menu and confirm it

Select

Wallpaper To display a wallpaper

Show date and time
To display the date and time

LCD backlight To set the brightness and lighting duration of the back-lighting

Themes To display a colour scheme





Refer to Menu Structure;  Page 92.

Ringer Profile settings

Use this menu to adapt the phone's ringing tones to your own personal needs.

Menu Open the main menu

 /  **User profiles** **OK**
Select the menu and confirm it

 /  **Options**  /  **Customize** **OK**
Select a profile and open the Options menu

Select

Tone settings To select specific ringing

Other Useful Features

melodies for various alert ringing signals

Volume

To select specific volumes for the various alert ringing signals



Exposure to the receiver at full volume for a long period could cause ear damage.

Alert type

To select whether you are alerted of incoming calls via a ringing tone or vibration

Ring type

To set the ringing type for the alerts

Extra tone

To set extra tones for certain situations

Answer mode

To select the key with which incoming calls can be taken

Refer to Menu Structure;  Page 95.

Example - Setting the loudest Ringer

The loudest ringer is MIDI 1 + Volume 7 = 100dB.

Menu

Open the main menu

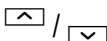





User profiles



OK

Select the menu and confirm it



Other Useful Features

 /  Options  /  Customize OK

Select your profile and open the Options menu

 /  Tone settings OK

Select the menu and confirm it

 /  Incoming call OK

Select the menu and confirm it

 /  MIDI 1 OK

Select the ringer and confirm it

Back

 /  Volume OK

Select the menu and confirm it

 /  Ringtone OK

Select the menu and confirm it

 7 OK

Select the volume and confirm it

Automatic key lock

You can set up the mobile phone so that the key lock is automatically activated after a certain time in Standby mode.



Menu

Open the main menu



Other Useful Features

 /  Settings  OK
Select the menu and confirm it

 /  Security settings  OK
Select the menu and confirm it

 /  Auto keypad lock  OK
Select the menu and confirm it



Dedicated function keys



You can define which menu or function should be opened on pressing the  /  keys in Standby mode.





 Menu Open the main menu

 /  Settings  OK
Select the menu and confirm it

 /  Phone settings  OK
Select the menu and confirm it

 /  Dedicated key  OK
Select the menu and confirm it

 /  Up or Down  Edit
Select the key

 /    OK
Select the required menu or function and confirm it

Other Useful Features

Call Settings



It is possible that not all functions described are supported by every provider. Therefore, please contact your local mobile phone provider for details. They may concern services which are subject to charges.

Caller ID

This function is used to activate/deactivate transmission of the phone number, with which you are making the call, with the call.

Menu

Open the main menu

/ Call centre

Select the menu and confirm it

/ Call settings

Select the menu and confirm it

/ Caller ID

Select the menu and confirm it

/ Set by network , Hide ID

or Select a setting and confirm it

Other Useful Features

Call waiting

This function issues an audible signal to inform you that another call has been received while the current call is in progress.

Menu		Open the main menu
<input type="button" value="^"/> / <input type="button" value="v"/>	<input type="button" value="Call centre"/>	<input type="button" value="OK"/>
		Select the menu and confirm it
<input type="button" value="^"/> / <input type="button" value="v"/>	<input type="button" value="Call settings"/>	<input type="button" value="OK"/>
		Select the menu and confirm it
<input type="button" value="^"/> / <input type="button" value="v"/>	<input type="button" value="Call waiting"/>	<input type="button" value="OK"/>
		Select the menu and confirm it
and then select		
<input type="button" value="Activate"/>	<input type="button" value="OK"/>	The call waiting function is then active.
<input type="button" value="Deactivate"/>	<input type="button" value="OK"/>	The call waiting function is deactivated
<input type="button" value="Query status"/>	<input type="button" value="OK"/>	Display the current setting

Other Useful Features

Forwarding calls

The following functions enable incoming calls to be transferred to other phone numbers.

Menu	Open the main menu
<input type="button" value="^"/> / <input type="button" value="v"/> Call centre	<input type="button" value="OK"/>
	Select the menu and confirm it
<input type="button" value="^"/> / <input type="button" value="v"/> Call settings	<input type="button" value="OK"/>
	Select the menu and confirm it
<input type="button" value="^"/> / <input type="button" value="v"/> Call divert	<input type="button" value="OK"/>
	Select the menu and confirm it
<input type="button" value="^"/> / <input type="button" value="v"/> Cancel all divers	<input type="button" value="OK"/>
	To stop all the calls being transferred

Select the setting for which calls should be redirected

-
-
-
-
-
-

Other Useful Features

and then select

Activate OK

To new number

OK



or

Search

OK

Enter the number or select it from the phone book.

or

To voice mail

OK

The call forwarding function is then active.

Deactivate

OK

The corresponding call forwarding function is deactivated

Query status

OK

Display the current setting

Other Useful Features

Call barring

The following function is used to restrict calls which can be received and made.

Menu Open the main menu

^ / v Call centre OK

Select the menu and confirm it

^ / v Call settings OK

Select the menu and confirm it

^ / v Call barring OK

Select the menu and confirm it

Select the setting for which calls should be restricted

Outgoing calls

All calls

International calls

International calls except to home PLMN



The home PLMN (**P**ublic **L**and **M**obile **N**etwork) is the network your SIM card is registered to.

Incoming calls

All calls

When roaming

Activate all

Call barring password 

Other Useful Features

Cancel all

Call barring password 

or

Change barring password

Old password 

New password 

Confirm new password 



OK

 The default password is 1234.



Automatic redialling

When this function is activated, redialling is initiated automatically if the number dialled is “engaged”.

Menu Open the main menu

 /  Call centre OK



Select the menu and confirm it

 /  Call settings OK

Select the menu and confirm it

 /  Advance settings OK

Select the menu and confirm it

 /  Auto redial On

Activate the function

Other Useful Features

Broadcast messages

You mobile phone supports receiving broadcast¹ messages.

 You receive information on broadcast messages, charge rates, data and offers from your SIM card service provider.

Menu

Open the main menu

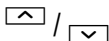

Messages

OK

Select the menu and confirm it

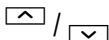

Broadcast message

OK

Select the menu and confirm it







Refer to Menu Structure;  Page 86.

¹ Broadcast, is also referred to as **CB = Cell Broadcast** (information services from your telephone network provider)

Other Useful Features

Default settings

The mobile phone can be reset to its default (factory) settings.

Menu	Open the main menu
 /  Settings OK	Select the menu and confirm it
 /  Security settings OK	Select the menu and confirm it
 /  Restore factory settings OK	Select the menu and confirm it
	The default password is 1234.

Bluetooth®

11 Bluetooth®

How to turn Bluetooth® On & Off

Menu Open the main menu

^ / v Extra OK
Select the menu and confirm it

^ / v Bluetooth OK
Select the menu and confirm it

^ / v Power On
Turn Bluetooth® on

or

^ / v Power Off
Turn Bluetooth® off



When Bluetooth® is on, the battery life is reduced, so we recommend that it should be switched off when not required!

Connect your M6000 to a Bluetooth® headset



It is possible to connect your M6000 mobile phone to a Bluetooth® headset via a Bluetooth® communication network.

Menu Open the main menu

^ / v Extra OK
Select the menu and confirm it

 /  Bluetooth 

Select the menu and confirm it

 /  Inquiry audio device 

Select the menu and confirm it

 Please refer to the manual supplied with your Bluetooth® headset for instructions on how to set the Bluetooth® headset to pairing mode.

 /  Pair 

Select the device and establish a connection

 0000 

Enter the PIN and confirm it

 The PIN required is stipulated in the manual supplied with your Bluetooth® headset.

After the devices have been successfully paired, further functions are available for selection;

 Page 97.

 Please refer to the manual supplied with your Bluetooth® headset for information on using the headset for phoning.

Emergency Call Function

12 Emergency Call Function

This mobile phone is equipped with a convenient emergency call function. Up to 5 phone numbers can be entered for emergency calls. For this function to work correctly it is necessary to record your personal message. See section below Page 76 Recording an SOS message.

Entering/Deleting emergency call numbers

Proceed as follows to define an entry in the phone book as an emergency call number.



Each number you want to define as an emergency call number must be already stored in the phone book.

Menu

Open the main menu

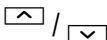

Settings

OK

Select the menu and confirm it

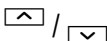

Help Setting

OK

Select the menu and confirm it

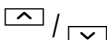

SOS setting

OK

Select the menu and confirm it

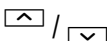

Set SOS numbers

OK

Select the menu and confirm it

Emergency Call Function

/ Options
Select a memory location and open the options

/ OK
Select the function and confirm it

/ Select entry and confirm it

The following functions can also be used:

View the entry

Delete the entry

Sending an emergency call

You can define whether an emergency call should only be sent to the numbers entered in “Set SOS numbers” or to a specific call centre.

Open the main menu



/ OK
Select the menu and confirm it

/ OK
Select the menu and confirm it

/ OK
Select the menu and confirm it

/ OK
Select the menu and confirm it

Emergency Call Function

 /  Set 5 numbers or
Set call centre or Off 

Select the mode and confirm it

Setting up a call centre number

Proceed as follows to set up a number.



 Open the main menu

 /  Settings 

Select the menu and confirm it

 /  Help Setting 

Select the menu and confirm it

 /  SOS setting 

Select the menu and confirm it

 /  Set call centre number 

Select the menu and confirm it

  Edit the number and confirm it









Recording an SOS message

When you make an emergency call, a message is sent. It is important for the person being called to understand that to accept this emergency call they need to press the “0” key. The M6000 will switch to hands free and the called party can listen in and have a conversation. The maximum length of this message is 15 seconds. We suggest the typical voice message should contain the following;

Emergency Call Function

This is ... **your name** ...

I need assistance - please press zero to accept my call.

Menu		Open the main menu
 / 	Settings	OK
		Select the menu and confirm it
 / 	Help Setting	OK
		Select the menu and confirm it
 / 	Record SOS message	OK
		Select the menu and confirm it
Options	 / 	Record OK
		Start recording
 Stop		Speak your message into the microphone and confirm it
Save audio?	Yes / No	
		Save or reject the recording
The following functions can also be used:		
Play		Play the message
Delete		Delete the message

Emergency Call Function

Fall Down Alarm - Please read carefully

The innovative and sophisticated sensor built into your telephone will function reliably, provided your telephone is always hung round your neck with a lanyard which can be purchased in any telephone shop. Should you fall, it will trigger your alarm and make the calls you have programmed without your having to locate your telephone and press the alarm key. In case the alarm is triggered inadvertently, simply press the alarm key up and down to cancel. You can choose to set the M6000 to normal or sensitive mode. This function should not be the sole method of seeking assistance.

When fall down is on you will see this icon  in the display of the phone.



If it is your intention to carry your telephone in your pocket, briefcase, or bag, false alarms may occur and you may prefer to switch the fall down sensor off as instructed.



False alarms to emergency call centres can result in considerable costs which could then be charged to you. Therefore, treat this function with due care and attention.

Menu

Open the main menu





Settings



OK

Select the menu and confirm it



Emergency Call Function

 /  Help Setting 

Select the menu and confirm it

 /  Man down SOS 

Select the menu and confirm it

 /  Normal or Sensitive 

Select the sensitivity and activate the function

or

 /  Off  Deactivate the function

Emergency Call Function, Examples

The emergency call function is explained here according to two examples.

Emergency calls to an emergency call centre

 False alarms to official emergency call centers can result in considerable costs which could then be charged to you.

 It may be necessary for you to register with an emergency call centre. Ask your doctor or community services for details.

Carry out the following settings:

 Open the main menu

 /  Settings 

Select the menu and confirm it



Emergency Call Function

 /  Help Setting 



Select the menu and confirm it



 /  SOS setting 

Select the menu and confirm it



 /  Set call centre number 

Select the menu and confirm it

  Edit the number and confirm it

 /  SOS mode setting 

Select the menu and confirm it

 /  Set call centre 

Select the mode and then confirm it

In the case of an emergency call:



















The phone dials the emergency call centre number. When a connection is established, the SOS message you recorded is sent. The connection then remains active for approx. 10 seconds. If the number of the emergency call centre is “engaged”, up to three further attempts are automatically made to dial the number.

Emergency call to several numbers

The required phone numbers must be stored in the phone book (relatives/friends).

Carry out the following settings:

Emergency Call Function

Menu	Open the main menu
 /  Settings	OK Select the menu and confirm it
 /  Help Setting	OK Select the menu and confirm it
 /  SOS setting	OK Select the menu and confirm it
 /  Set SOS numbers	OK Select the menu and confirm it
 /  <input type="text"/>	Options Select a memory location and open the options
 /  Change	OK Select the function and confirm it
 /  OK	Select entry and confirm it
After up to 5 emergency numbers have been set	
Back	
 /  SOS mode setting	OK Select the menu and confirm it
 /  Set 5 numbers	OK Select the mode and then confirm it

Emergency Call Function

In the case of an emergency call:

The phone dials the 1st emergency call number. When a connection is established, the SOS message you recorded is sent. The connection then remains active for approx. 10 seconds before the next number is dialled. If a phone number is “engaged” or an answering machine takes the call, the mobile phone automatically dials the next emergency call number (after approx. 1-2 minutes). When the called party receives your emergency call they will hear your recorded voice message and must accept the call by pressing 0. Your Emergency call is now in hands free mode. Remember to switch the emergency call switch off.

Starting the emergency call

Slide the **emergency call switch** upwards. A siren is sounded. The phone dials the set number. Depending on the settings selected, the number is redialled or the next number is dialled.

Ending the emergency call

After making the call or to cancel the emergency call, slide the **Emergency call switch** back down.

Terminating the “man down” SOS

If the function is triggered unintentionally, slide the **Emergency call switch** up and then immediately back down again.

13 Services

This menu contains the SIM Application Toolkit (commonly referred to as STK) of your mobile phone provider. The content and functions available vary from provider to provider and are dependent on the SIM card used.

SIM Application Toolkit (STK) is a GSM system standard which enables the SIM to initiate actions which can be used for various value-added services.



Please contact your local mobile phone provider for details. They may concern services which are subject to charges.

Menu Structure

14 Menu Structure

Main menu

Pressing the **MI** = **Menu** key to open the main menu. Then use the **^** / **v** keys to select a menu option and confirm the selection. For further information on the menu and operation,  Chapter 4.

Messages

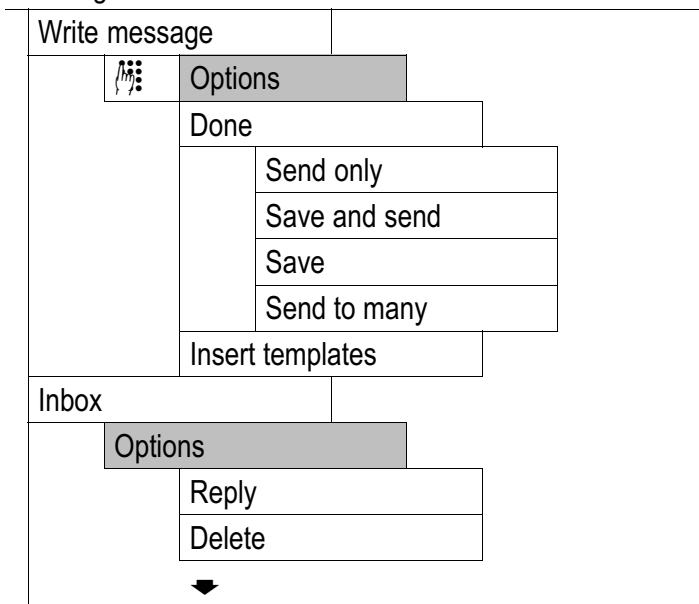

Menu Structure

	Forward
	Copy to phone / Copy to SIM
	Move to phone / Move to SIM
	Use number
Outbox	
	Options
	Send
	Edit
	Delete
	Copy to phone / Copy to SIM
	Move to phone / Move to SIM
	Use number
Templates	
SMS settings	
	Profile settings
	Common settings
	Delivery report
	↓

Menu Structure

	Reply path	
	Memory status	
	Preferred storage	
	SIM	
	Phone	
Voicemail server		
Broadcast message		
	Receive mode	
	Read message	
	Languages	
	Channel settings	

Call centre

Call lists	
Missed calls	
Options	
Delete	
Save to Phonebook	
Call	
Send text message	
Dialled calls	
see Missed calls	
Received calls	
see Missed calls	
Delete call lists	
Missed calls	
Dialled calls	
Received calls	
Delete all	
Call timers	
Last call	
↓	

Menu Structure

	Dialled calls
	Received calls
	Reset all
Call cost	
	Last call cost
	Total cost
	Reset cost
	Max cost
	Price per unit
Call settings	
Caller ID	
	Set by network
	Hide ID
	Send ID
Call waiting	
	Activate
	Deactivate
	Query status
Call divert	
	Divert all voice calls
	↓

Menu Structure

	Divert if unreachable
	Divert if no answer
	Divert if busy
	Divert all data calls
	Cancel all divers
Call barring	
	Outgoing calls
	All calls
	International calls
	International calls except to home PLMN
	Incoming calls
	All calls
	When roaming
	Activate all
	Cancel all
	Change barring password
Closed user group	
Advance settings	
	Auto redial
	Call time display

Menu Structure

Phonebook

Add new contact	
	To SIM
	To phone
Set M1/M2/M3	
	M1 call number
	M2 call number
	M3 call number
Copy	
	To phone
	To SIM
Copy all	
	From SIM
	From phone
Delete	
Delete all	
	From SIM
	From phone



Menu Structure

Speed dial	
	Status
	Set number
Phonebook settings	
	Extra numbers
	Owner number
	Service dialing number
	SOS number
Memory status	
Preferred storage	
	SIM
	Phone

Menu Structure

Settings

Phone settings

Time and date

Set time/date

Set format

Schedule power on/off

Language

Display characteristics

Wallpaper

Show date and time

LCD backlight

Brightness

Time

Themes

Dedicated key

Up

Down



Menu Structure

Tone control		
	Normal	
	Low frequency	
	High frequency	
Help Setting		
	SOS setting	
	SOS mode setting	
		Set 5 numbers
		Set call centre
		Off
	Set SOS numbers	
	Set call centre number	
	Man down SOS	
	Normal	
	Sensitive	
	Off	
	Record SOS message	
Network settings		
	Network selection	
	New search	
		

Menu Structure

		Select network
		Selection mode
	Preferences	
Security settings		
	SIM lock	
	Phone lock	
	Auto keypad lock	
	Fixed dial	
	Mode	
	Fixed dial list	
	Barred dial	
	Mode	
	Barred dial list	
	Change password	
	PIN	
	PIN2	
	Phone password	
Restore factory settings		

User profiles

General	
Activate	
Customize	
Tone settings	
Incoming call	
Alarm	
Power on	
Power off	
Message	
Keypad	
Volume	
Ringtone	
Key tone	
Alert type	
Ring only	
Vib. only	
Vib. and ring	
Vib. then ring	
	

Menu Structure

	Ring type	
	Single	
	Repeat	
	Ascending	
	Extra tone	
	Warning	
	Error	
	Camp on	
	Connect	
	Answer mode	
	Any key	
Meeting		see General
Outdoor		
Indoor		
Headset		
Bluetooth		

Extra

Calendar	
Alarm	
Calculator	
Bluetooth	
	Power
	Inquiry audio device
	My device
	Active devices
	About

Services Page 83

(provider-dependent menu)

Trouble Shooting

15 Trouble Shooting

Service hotline

Should problems arise with the telephone, please refer to the following information first. In the event of technical problems, please contact our service hotline under tel. 0844 800 6503 (Using an UK landline, at the time of going to print: calls cost 6p for connection charge and then 5p a minute. Mobile costs may vary.) In the case of claims under the terms of guarantee, contact your sales outlet. There is a 2 year period of guarantee.

Problems and solutions

Problems	Solutions
The mobile phone cannot be switched on.	<ul style="list-style-type: none">- No battery inserted.- Battery is not charged.
The display is "locked" when the mobile is switched on.	<ul style="list-style-type: none">- Enter the PUK to "unlock" the SIM card.- Contact your service provider.
A message appears in the display for some functions, indicating execution/use is not possible.	<ul style="list-style-type: none">- Many functions can only be used after the respective service has been applied for.- Contact your service provider.

Trouble Shooting

No signal quality is displayed.	<ul style="list-style-type: none">- No network connection. The mobile phone is in a location where there is no network service. Move to a different location or contact your service provider.
Keypad does not function or only functions very slowly.	<ul style="list-style-type: none">- The operating speed of the display is reduced in the case of low temperatures. This is normal. Use the phone in a warmer location.
Screen frozen or no response when pressing keys.	<ul style="list-style-type: none">- Remove the battery for 3 minutes and try again.
No connection to the mobile telecommunication network.	<ul style="list-style-type: none">- Contact your service provider.
The “Insert SIM” message appears in the display.	<ul style="list-style-type: none">- Ensure that the SIM card has been installed correctly. Contact your service provider, if necessary.

Trouble Shooting

The battery cannot be charged or is empty within a short time.

- Battery is defect.
- Place the phone correctly in the charging unit or connect the charging unit properly. Clean the contact surfaces on the mobile phone and charging unit with a soft, dry cloth.
- Charge the mobile for 4 hours.

Tips on the battery

Only use batteries, cables and charging unit approved by the manufacturer, otherwise the battery could be damaged.

Do not short circuit the battery. Always leave the battery in the phone to avoid accidentally short circuiting the battery contacts.

Keep the battery contacts clean and free of dirt.

The battery can be charged/discharged hundreds of times but its service life is limited. Replace the battery when the battery power has decreased noticeably.

16 Technical Properties

Technical data

Feature	Value
Standard	GSM ¹ 900, 1800, 1900 MHz Triband
Dimensions	50.5 x 134 x 17 mm (W x H x D)
Weight	< 100 g incl. battery
Power supply	Input: 100-240 V, 50-60 Hz, 0.2 A Output: Mini-USB 5 V, 500 mA
Battery	Model: BP-75LI 3.7 V, 750 mAh
Standby time	Up to 230 h
Max. talk time	Up to 150 min
Display	2" Colour, Resolution 176 x 220
SMS	Standard SMS

¹ **GSM** = Standard for mobile phones.

Technical Properties

Permissible ambient temperature	-10°C to 40°C
Permissible relative humidity	30% to 75%



All Rights Reserved!

Default settings

The default settings can be restored via the menu.

Declaration of Conformity

This device fulfils the requirements stipulated in the EU directive:

1999/5/EU directive on radio equipment and telecommunications terminal equipment and the mutual recognition of their conformity.

Conformity with the above mentioned directive is confirmed by the CE mark on the device.

To view the complete Declaration of Conformity, please refer to the free download available on our web site www.amplicomms.eu.

C **€** 1588

SAR Information

Information on radio frequency emissions and specific absorption rates (**SAR = Specific Absorption Rate**).

All the applicable safety standards related to radio frequency emissions were implemented during the development of this mobile phone. The limit values are based on scientific directives and contain a safety margin in order to guarantee the safety of all persons regardless of age and state of health.

The values specified in the directive concerning radio frequency emissions are based on a unit called SAR. SAR values are established using standard methods in which the phone is operated in all possible frequency bands with the highest power output.

Although the SAR values of various phone models can differ, all the models were developed to maintain the relevant directives on radio frequency emissions. The following information applies to residents of countries which, as with the European Union, have adopted the SAR limit value recommended by the ICNIRP (**I**nternational **C**ommission on **N**on-**I**onizing **R**adiation **P**rotection) which lies at 2W/Kg (averaged from 10 gram tissue):

The highest SAR value measured, averaged over 10 g tissue, was < 0.422 W/kg for this mobile phone measured at the ear.

Safety Information

17 Safety Information

Please read this section carefully.



Risk of suffocation!

Keep packaging materials and protective foils out of reach of children.

Intended use

This mobile phone is designed for use when connected to a mobile phone network. Any other use is considered unintended use. Unauthorised modification or reconstruction is not permitted. Under no circumstances open the device or complete any repair work yourself.

Areas of use

- Do **not** use the phone in prohibited areas.
- Switch the phone off in the vicinity of medical equipment (e.g. in hospitals).
- Do not use the phone in petrol stations or near fuels and chemicals.
- Check with the airline whether mobile phones may be used on board.

General information

- Prevent exposure to smoke, dust, vibration, chemicals, moisture, heat and direct sunlight. The phone is not waterproof; therefore, keep it dry.
- Only use original accessories and batteries. Never attempt to connect other products.
- If you want to connect the phone to another device, read the manual supplied with that device with regard to any detailed safety information. Never attempt to connect incompatible products.
- Repairs to this device may only be completed by qualified service personnel.
- All mobile communication equipment is subject to interference which may impair its performance.
- Keep the phone and accessories out of the reach of children.
- The SIM card can be removed. Caution! Small children can swallow them.
- The ringing tone is issued via the loudspeaker. Take an incoming call first and then hold the phone to your ear. This prevents any possible hearing damage.

Safety Information

- Only use the phone while driving or riding a transport vehicle in road traffic when using the approved handsfree equipment and appropriately positioned holders. Ensure that no safety-related functions are interfered with when operating the phone. It is essential to observe the applicable national laws and regulations.
- Always maintain a distance of at least 15 cm to implanted heart pacemakers to prevent any possible interference. If you have had a pacemaker implanted, do not carry the phone in a breast pocket when switched on. Always hold the phone to the ear furthest away from the pacemaker during calls. Switch the phone off immediately if you notice or suspect any adverse effects.
- This phone is hearing aid compatible. If you wear a hearing aid, however, please contact your doctor or the hearing aid manufacturer to inquire about any possible impairments through mobile communication equipment.
- Do not rely on the mobile phone as a safeguard for emergencies. For a variety of technical reasons, it is not possible to guarantee a reliable connection under all circumstances.

Power adapter plug



Attention: Only use the power adapter plug supplied because other power supplies could damage the phone. Ensure access to the power adapter plug is not obstructed by furniture or such.



The power adapter plug supplied fulfils the ecodesign requirements of the European Community (Directive 2005/32/EC). This means that the current consumption is considerably less, both in operation as well as in standby, in comparison to older power adapter plug models.

Rechargeable batteries



Attention: Never throw batteries into a fire. Only use batteries of the same type.

Barcode labels on the phone

The barcode label contains information on the phone, such as the serial number, for example. Do not remove it.

Safety Information

Disposal

In order to dispose of your device, take it to a collection point provided by your local public waste authorities (e.g. recycling centre). According to laws on the disposal of electronic and electrical devices, owners are obliged to dispose of old **electronic and electrical devices** in a separate waste container. The symbol indicates that the device must not be disposed of in normal domestic waste!



Batteries represent a hazard to health and the environment!



Never open, damage or swallow batteries or allow them to pollute the environment. They may contain toxic, ecologically hazardous heavy metals. You are legally obliged to dispose of power packs and batteries at the point of sale or in the corresponding containers provided at collection points by local public waste authorities. Disposal is free of charge. The symbols indicate that the batteries must not be disposed of in normal domestic waste and that they must be brought to collection points provided by local public waste authorities.

Packaging materials must be disposed of according to local regulations.

18 Maintenance / Guarantee

Maintenance

- Clean the housing surfaces with a soft, fluff-free cloth.
- Do not use any cleaning agents or solvents.

Guarantee

AMPLICOMMS equipment is produced and tested according to the latest production methods. The implementation of carefully chosen materials and highly developed technologies ensure trouble-free functioning and a long service life. The terms of guarantee do not apply when a device malfunction was caused by the mobile telecommunications network operator/provider. The terms of guarantee do not apply to the batteries or power packs used in the products. The period of guarantee is 24 months from the date of purchase.

All deficiencies related to material or manufacturing errors within the period of guarantee will be redressed free of charge. Rights to claims under the terms of guarantee are annulled following tampering by the purchaser or third parties.

Maintenance/ Guarantee

Damage caused as a result of improper handling or operation, normal wear and tear, incorrect positioning or storage, improper connection or installation or Acts of Gods and other external influences are excluded from the terms of guarantee. In the case of complaints, we reserve the right to repair defect parts, replace them or replace the entire device. Replaced parts or devices become our property. Rights to compensation in the case of damage are excluded where there is no evidence of intent or gross negligence by the manufacturer.

If your device shows signs of defect during the period of guarantee, please return it to the sales outlet in which you purchased the AMPLICOMMS device together with the purchase receipt. All claims under the terms of guarantee in accordance with this agreement can only be asserted at the sales outlet. No claims under the terms of guarantee can be asserted after a period of two years from the date of purchase and hand-over of the product.

19 Index

A

- Alarm, 52
- At a Glance, 4, 16
- Automatic key lock, 62
- Automatic redialling, 69

B

- Battery charge status, 8
- Battery status warning, 9
- Bluetooth, 72
- Broadcast messages, 70

C

- Calculator, 54
- Calendar, 52
- Call barring, 68
- Call list, 34, 38
- Call Settings, 64
- Call waiting, 65
- Caller ID, 64
- Calling back, 34
- Calling back missed calls, 34
- Charging, 8
- Creating
 - phone book entries, 27, 31

D

- Date, 11, 50
- Declaration of Conformity, 102
- Dedicated function keys, 63
- Default settings, 71, 102
- Deleting phone book entries, 32
- Dialling, 34
- Display, 18
- Display icons, 18
- Display language, 11
- Display settings, 59
- Displaying list details, 39
- Disposal, 108
- During a call, 37

Index

E

- Editing phone book entries, 32
- Emergency call function, 74
- Emergency call function, examples, 79
- Emergency call to several numbers, 80
- Emergency calls to an emergency call centre, 79
- Ending a call, 11, 34
- Ending the emergency call, 82
- Energy-save mode, 25
- Entering names, 31
- Entering Text, 28
- Entering text, 31
- Entering/Deleting emergency call numbers, 74

F

- Forwarding calls, 66

G

- Getting Started, 24
- Guarantee, 109

H

- Handsfree, 35
- High Frequency, 55
- Hold, 37
- How does it work, 20
- How to enter text and numbers, 28

I

- Icons, 18
- Intended use, 104

K

- Keypad lock, 36
- Keys and Parts, 16

L

- Language, 51
- Loudest Ringer, 11
- Low Frequency, 55

M

- Main menu, 84
- Maintenance , 109
- Making a call, 11, 34
- Making and Receiving Calls, 34
- Man down SOS, 78
- Menu structure, 84
- Modifying phone book entries, 32
- Multitap, 28
- Muting, 36
- Muting function, 37

N

- Network, 10
- Network settings, 56
- New call, 37
- Notation, 24

O

- On-hook, 34
- One-touch dialling, 35
- One-touch dialling keys, 48
- Other Useful Features, 48

P

- Package contents, 6
- Personal PIN, 58
- Phone Book, 30
- Phone book, 27, 34, 37
- Phone settings, 59
- PIN/PIN2 code, 59
- Problems, 98
- Problems and solutions, 98
- PUK/PUK2 code, 59
- Punctuation and special characters, 29

Q

- Questions and Answers, 12
- Quick Start Guide, 4

R

- Receiver volume, 35
- Recording an SOS message, 76
- Redialling, 34
- Reject, 11, 34
- Rejecting a call, 11, 34
- Ring tone, 60
- Ringer Profile settings, 60

Index

S

Safety information, 104
SAR Information, 103
Saving phone book entries, 27
Security settings, 57
Sending an emergency call, 75
Service-Hotline, 98
Services, 83
Setting the
 loudest Ringer, 11, 61
Setting up a
 call center number, 76
SIM Application Toolkit, 83
SIM card, 6
SMS, 40
SMS settings, 40
Softkeys, 25
SOS, 74
Speed dial, 49
Standby mode, 25
Starting the emergency call, 82
Switching off, 10
Switching on, 10

T

Taking a call, 11, 34
Talk time, 35
Technical data, 101
Time, 11, 50
Tips on the battery, 100
Tone Control, 55
Tone settings, 60
Trouble shooting, 98
Turn ringer Off/On, 36

U

Unlock keypad, 36

V

Voice Mail, 46
Volume, 61

W

Writing an SMS text, 43

Notes

Important Notes on the Guarantee

The period of guarantee for the AMPLICOMMS product begins on the date of purchase. Rights to claims under the terms of guarantee relate to deficiencies resulting from material or production faults. Rights to claims under the terms of guarantee are annulled following intervention by the purchaser or third parties. Damage caused as a result of improper handling or operation, normal wear and tear, incorrect positioning or storing, improper connection or installation, Acts of God or other external influence are not covered by the terms of guarantee.

CLAIMS UNDER THE TERMS OF GUARANTEE MAY ONLY BE ASSERTED TO THE RETAILER WHERE THE EQUIPMENT WAS PURCHASED, WHEREBY THE PURCHASE RECEIPT MUST ALSO BE SUBMITTED.

TO PREVENT UNNECESSARY LONG DELAYS, PLEASE DO NOT SEND EQUIPMENT UNDER COMPLAINT TO OUR OFFICE ADDRESS.

IN THE CASE OF QUESTIONS CONCERNING OPERATION OR THE TERMS OF GUARANTEE, PLEASE REFER TO THE OPERATING MANUAL OR CONTACT OUR HOTLINE: 0844 800 6503

(Using an UK landline, at the time of going to print:
calls cost 6p for connection charge and then 5p a minute.

Mobile costs may vary.)

AUDIOLINE GmbH

Neuss

Internet: www.amplicomms.eu - E-mail: info@audioline.de