

F-05J

arrows Be

INSTRUCTION MANUAL '17.5

Introduction

Thank you for purchasing "F-05J" mobile terminal.
Before using your terminal, or when necessary, read this manual to ensure safe use and handling.

Learning operations

"クイックスタートガイド (Quick start guide)" (included with the terminal) (in Japanese only)

This guide provides information of parts names and functions.

"Instruction Manual" application (e-manual)
(installed in the terminal) (in Japanese only)

This manual provides detailed information and operations of the functions.

<Operation steps> From the Home screen,  → [Instruction Manual]

When activating for the first time, follow the onscreen instructions to download "Instruction Manual" application.

If you delete "Instruction Manual", you can access Google Play™ from Play Store to install again.

<Operation steps> From the Home screen, [Play Store] → Search "取扱説明書 (Instruction Manual) F-05J" and select "取扱説明書 (Instruction Manual)" → [INSTALL]

"INSTRUCTION MANUAL" (PDF file)

This manual provides detailed information and operations of the functions.

<From PC><https://www.nttdocomo.co.jp/english/support/trouble/manual/download/f05j/index.html>

*You can download the latest information. The URL and contents are subject to change without prior notice.

Viewing this manual

- In this manual, "F-05J" mobile terminal is usually referred to as "the terminal".
- The images or illustration used in this manual are examples. They may differ from the actual displays.
- In this manual, explanations and screen images for terminal color "Red", "docomo LIVE UX" as Home application and "Red" as Kisekae are provided.
- In this manual, "authenticate" indicates the operating procedure for entering security code or password depending on functions.
- Unauthorized copying of parts of or this entire manual is prohibited.
- The contents in this manual, URL and contents are subject to change without prior notice.

Basic package

■ F-05J (with warranty)

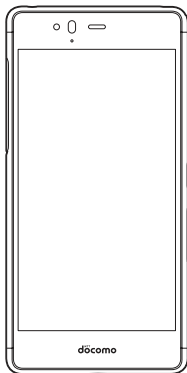

- クイックスタートガイド (Quick start guide) (in Japanese only)
ご利用にあたっての注意事項 (Notes and instructions for use) (in Japanese only)

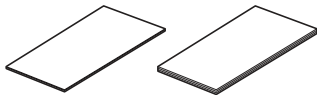

- You can check or purchase optional accessories compatible with the terminal (optional) in the DOCOMO online shop.
<https://www.mydocomo.com/onlineshop/options/index.html> (In Japanese only)

Contents

■ Basic package	1
■ Before using the terminal	5
■ Precautions (Always follow these directions)	7
■ Handling precautions	17
■ Waterproofness/Dustproofness, shock resistance	23

Before using the terminal 29

Part names and functions	29
docomo nano UIM card	31
microSD card	33
Charging	35
Turning power on/off	37
Basic operation	38
Character entry	41
Initial settings	47
Indicator LED	49
Screen/icon	49
Task manager	56
Split screen	56
Switching the home applications	57
Child proof	57

docomo LIVE UX 58

Home screen	58
Application list	60
Backup and restoration of Home screen	65
My Magazine	65
Information of Home app	66

Calling 67

Making a call/video call	67
Receiving a call/video call	69
Operation during a call	70
Recent calls	72
Phone memo	73
Call settings	73
Phonebook	76

Mail/Browser 80

docomo mail	80
Messaging (SMS)	80
Gmail	82
NX! Mail	83
Early warning "Area Mail"	86
Browser	87

Applications 92

dmenu	92
dmarket	92
Play Store	92
Osaifu-Keitai	94
1Seg	97
Camera	102
Gallery	110
Media Player	111
Location data/GPS	113
Schedule	115
Clock	116
Calculator	118
Search	118
docomo Data Copy	119

Settings 122

Setting menu	122
Wi-Fi	123
Data usage	127
Airplane mode	128
Tethering	129
VPN (Virtual Private Network)	130
Cellular networks	131
Network settings reset	132
Display & Wallpaper	133
Notifications	135
Sound	136
Apps	138
Storage	139

Battery	139
Memory	140
Users	140
Gestures	141
docomo service/cloud	142
Security	143
Accounts	154
Google	155
Languages & input	155
Backup & reset	157
Useful tools	158
Date & time	160
Accessibility	161
About phone	161

File management 162

Storage (Internal storage)	162
microSD card (External storage)	162
File operations	162

Data communication 164

Bluetooth [®] communication	164
NFC communication	167

External device connection 169

Connecting with a PC	169
Connecting with a printer	169
Connecting with other devices	171

International roaming 172

Outline of international roaming (WORLD WING)	172
Available services for overseas	172
Before using the terminal overseas	173
Making/Receiving a call in the country you stay	175
Setting international roaming	176
After returning to Japan	177

Appendix/Index 178

Troubleshooting (FAQ)	178
Anshin Enkaku Support	184
Warranty and After-Sales Service	185
Software update	187
Main specifications	190
Specific Absorption Rate (SAR) of Mobile Phones	193
Export Administration Regulations	198
Intellectual Property Right	198
SIM unlock	201
Index	202



Before using the terminal

- This terminal supports LTE, W-CDMA, GSM/GPRS, Wireless LAN System.
 - Since the terminal uses wireless signal, it may not be able to use in a location with no signal reception such as a tunnel, underground, a building, an outdoor location with weak or poor signal reception, or a location outside of the LTE and FOMA service areas. Even when you are high up in a tall building or condominium and nothing blocks your view outside, your terminal may not be able to receive or transmit signals. Also, communication may be interrupted even when there are strong radio waves with 4 signal status icons on the terminal and you are not moving (traveling).
 - Because your terminal uses radio waves to communicate, it is possible that a third party may attempt to tap your calls. However, the LTE, W-CDMA, GSM/GPRS automatically applies a confidential communication function to all calls, so even if a third party could somehow tap a call, they only hear noise.
 - Your terminal encodes voice communication as digital data. When you are operating your terminal while moving to a location subject to weaker radio wave conditions, the transmitted digital data may not be correctly decoded and as a result the decoded voice may differ somewhat from the actual voice.
- Since the terminal has the function that allows users or guests to use the terminal, depending on the service or application, you may be regarded as the same person after changing users.
Note that DOCOMO assumes no responsibility for any damage or trouble to you or a third party resulting from using the function.→P140
 - Maintain a separate record of the data saved in the terminal by taking notes periodically or saving in the external memory such as a microSD card or PC. Note that DOCOMO assumes no responsibility for any loss of saved contents of data resulting from malfunction, repair, changing of the model or other handling of the terminal.
 - In the terminal, as it is for a PC, some applications that you install or Web sites that you access may give instability of the operation, or may send your location information or personal information registered to the terminal to outside via the Internet and the information may be used improperly. Please thoroughly check a provider and operation status of the application etc. which you want to use beforehand and then use it.
 - This terminal supports FOMA Plus-Area and FOMA HIGH-SPEED Area.
 - The terminal does not support i-mode sites (programs) or i-αpli.
 - You can use the terminal only with a docomo nano UIM card. If you have a docomo mini UIM card, docomo UIM card, or FOMA card, bring it to a docomo Shop to replace it with a docomo nano UIM card.
 - Public mode (Driving mode) is not supported.

- Regardless of Manner mode setting, shutter sound, shooting start/end sound, auto focus lock sound, count down sound for self-timer, screen shot sound while the camera is activated, capturing sound for Capture & Draw/ Highlight & Copy, and Find Me Ringtone for Bluetooth Low Energy Settings are emitted.
- You can check your phone number (own number) operate from the Home screen, →[Settings]→[System]→[About phone]→[Status]→[SIM status] and see "My phone number".
- The terminal automatically performs communication for synchronizing data, checking the latest software version, and maintaining a connection with the server, and for other purposes. If you transmit a large amount of data, such as when downloading applications or watching video, the packet communication charge becomes high. Subscription to Packet Pack/packet flat-rate service is highly recommended.
- Depending on the applications or service you use, packet communication charge may be applied even in Wi-Fi communication.
- The software on the terminal can be updated with the latest information.→P187
- Improving the terminals quality or upgrading operation system may be included in the software update. And some applications used in the previous version may not be available or some unintended bugs may occur after software update.
- Display is manufactured by taking advantage of highly advanced technology but some dots may be always or never lit. Note that, this shows characteristics of liquid crystal displays and not defects in the terminals.
- For commercially available option devices, DOCOMO is not liable to any failures or the malfunctions.
- When the memory space of the microSD card or the terminal is low, running applications may not operate normally. In this case, delete the saved data.
- Applications and service contents are subject to change without prior notice.
- To use the third parties' services and applications including applications provided by Google Inc., refer to the terms of use of Google Inc. or the corresponding provider. DOCOMO assumes no responsibility for any malfunctions resulting from the services and applications.
- When the terms of use screen appears, follow the onscreen instructions.
- If you have lost your terminal, change your account passwords using a PC to prevent others from using your Google services such as Gmail™ and Google Play, SNS, and other services.
- Set the security unlock method to ensure the security of your terminal for its loss.→P145
- The terminal supports only sp-mode, mopera U and Business mopera Internet. Other providers are not supported.
- If you want to use tethering, subscription to Packet Pack/ packet flat-rate service is strongly recommended.
- For details on usage fee, refer to NTT DOCOMO website.







Precautions (Always follow these directions)

- Before using your terminal, or when necessary, read the precautions below to ensure safe use and handling.
- These precautions are intended to protect you and others around you. Read and follow them carefully to avoid injury, damage to the product or damage to property.
- The signs below differentiate between the levels of danger that can occur if the product is not used within the specified guidelines.

 DANGER	This sign denotes that "death or serious injury ^(*1) may directly result from improper use".
 WARNING	This sign denotes that "death or serious injury ^(*1) may result from improper use".
 CAUTION	This sign denotes that "minor injury ^(*2) or damage to property ^(*3) may result from improper use".

- *1 Serious injury: This refers to loss of sight, injury, burns (high- and low-temperature), electric shock, broken bones, injuries with residual aftereffects from poisoning, etc., and injuries requiring hospital admission for treatment or long term hospital attendance as an outpatient.

- *2 Minor injury: This refers to injuries, burns (high- and low-temperature), electric shock, etc. that do not require hospital admission for treatment or long-term hospital attendance as an outpatient.
- *3 Physical damage: This refers to extended damage to buildings, furniture, livestock, pets, etc.
- The symbols below show specific directions.

 Don't	Denotes things not to do (prohibition).
 No disassembly	This symbol denotes that disassembling the phone or its components is not allowed.
 No liquids	This symbol denotes that using the phone or its components in a bathroom or other highly humid area is not allowed.
 No wet hands	This symbol denotes that using the phone or its components with wet hands is not allowed.
 Do	Denotes mandatory instructions (matters that must be complied with).
 Unplug	This symbol denotes that the equipment should be unplugged.

■ Precautions contain the description below.

Handling the terminal, adapter, and docomo nano UIM card (common).....	8
Handling the terminal	10
Handling the adapter	13
Handling the docomo nano UIM card	15
Handling mobile phones near electronic medical equipment	15
Material list	16

◆ Handling the terminal, adapter, and docomo nano UIM card (common)

DANGER



Don't

Do not use, store or leave the terminal in hot places (e.g. by the fire, near a heater, under a kotatsu or futon, in direct sunlight, in a car in the hot sun).

May cause fire, burns, injuries, electric shock.



Don't

Do not put the terminal into or near a heating cooking device such as a microwave oven or IH cooker, or high-pressure container such as a pressure cooker.

May cause fire, burns, injuries, electric shock.



Don't

Do not put sand, dirt, or mud on the terminal or put it on them directly. Do not touch the terminal with hands to which sand or others adhere.

May cause fire, burns, injuries, or electric shock.

For the waterproof and dustproof functions, refer to the following.

→P23 "Waterproofness/Dustproofness, shock resistance"



Don't

Do not charge when the terminal is wet with water (drinking water, perspiration, seawater, urine of pet animals, etc.).

May cause fire, burns, injuries, or electric shock.

For the waterproof function, refer to the following.

→P23 "Waterproofness/Dustproofness, shock resistance"



Don't

Do not subject the terminal to strong pressure or break the terminal. Especially when bringing the terminal putting in a pocket of clothes, do not let the terminal hit against surroundings or being put between the objects.

May cause fire, burns, or injury due to ignition, rupture, overheating, or leak of the internal battery.

* The following are examples that you should be careful of:

- Sitting or squatting with the terminal put in a pocket of trousers or skirt
- Putting the terminal in a pocket of outer wear and catching them in a door or a door of car
- Stepping on the terminal on a soft object such as a sofa, bed, or bedding, or on a floor



No disassembly

Do not disassemble or remodel the equipment.

May cause fire, burns, injuries, electric shock.



No liquids

Do not let the terminal get wet with water (drinking water, perspiration, seawater, urine of pet animals, etc).

May cause fire, burns, injuries, electric shock.

For the waterproof function, refer to the following.

→P23 "Waterproofness/Dustproofness, shock resistance"



No liquids

Do not allow liquid (drinking water, perspiration, seawater, urine of pet animals, etc.) to come into the charging jack, external connection jack.

May cause fire, burns, injuries, electric shock.
For the waterproof function, refer to the following.
→P23 "Waterproofness/Dustproofness, shock resistance"



Do

Use the optional products specified by NTT DOCOMO for your cellphone.

May cause fire, burns, injuries, electric shock.



WARNING



Don't

Do not drop, trample, or throw the terminal or give a strong force or vibration to it.

May cause fire, burns, injuries, electric shock.



Don't

Keep conductive materials (metal pieces, pencil lead, etc.) from coming in contact with the charging jack or external connection jack, or dust into the terminal.

May cause fire, burns, injuries, electric shock.



Don't

Do not cover or wrap the terminal with a blanket etc. while using or charging.

May cause fire or burns.



Do

If charging is not complete after the specified charging time has passed, stop charging.

Not doing so may cause fire, burns, or injuries due to overcharge.



Do

Make sure to turn off the terminal or stop charging before you get close to places like a gas station where a flammable gas or dust can be generated.

Not doing so may cause the gas to ignite or fire.
When using Osaifu-Keitai in a place such as a gas station, turn OFF the terminal before using it (When NFC/Osaifu-Keitai lock is activated, deactivate it before turning OFF the terminal).



Do

If the equipment gives off a strange smell, noise, smoke, or overheats or becomes discolored or deformed during use, charge, or storage, perform the following operations.

- Remove the power plug from the wall outlet or accessory socket.
- Turn the terminal OFF.

Failure to do the above operations may cause fire, burns, injuries, or electric shock.



CAUTION



Don't

Do not use the damaged terminal.

May cause fire, burns, or injuries.



Don't

Do not leave the terminal on unstable or sloping surfaces. Be careful especially while the vibrator is set.

The equipment may fall and cause injuries.



Do not store the equipment in extremely humid, dusty or hot areas.

Don't

May cause fire, burns, electric shock.
For the waterproof and dustproof functions, refer to the following.

→P23 "Waterproofness/Dustproofness, shock resistance"



When children use the terminal, do not let them use incorrectly without instruction by an adult for proper use.

Don't

May cause injuries.



Do not store the terminal within the reach of small children.

Don't

Failure to do so may cause accidental ingestion, injury, or electric shock.



Be careful when using the terminal continuously for a long time or charging as it gets hot. Also, avoid touching the terminal for a long time by falling asleep unintentionally.

Do

If you use applications, talk on the phone, 1Seg, or watch videos for a long time or while charging the battery, the terminal and adapter may become hot. Directly touching a hot part for a long time, you may have redness, itching or rash on your skin, or it may result in low-temperature burns depending on your constitution and/or health condition.

◆ Handling the terminal



DANGER



Do not throw the terminal into fire or apply heat.

Don't

May cause fire, burns, or injury due to ignition, rupture, overheat, or leak of the internal battery.



Do not put excessive force such as sticking a nail into the terminal, hitting it with a hammer, or stepping on it.

Don't

May cause fire, burns, or injury due to ignition, rupture, overheat, or leak of the internal battery.



If the internal substance of the terminal contacts your eyes or mouth, immediately rinse your eyes with clean water and see a doctor right away.

Do

Failure to do so may cause blindness, medical problem, etc. due to effects of the internal substance of the terminal etc.



WARNING



Do not turn on or flash the light with the lighting part close to person's eye. Keep enough distance especially from small children.

Don't

May impair eyesight. And may cause accidents like injury etc., by dazzling or astounding other people.



Do not turn on or flash the light toward drivers of cars, etc.

Don't

May disturb driving and cause an accident, etc.



Don't

Do not watch the display that blinks repeatedly for a long time.

May cause spasm, loss of consciousness, etc.



Don't

Do not put foreign objects such as liquid like water (drinking water, perspiration, seawater, urine of pet animals, etc.), metal pieces or burnable things into the docomo nano UIM card/microSD card slot.

Insert the docomo nano UIM card or the microSD memory card in the correct place and in correct direction.

May cause fire, burns, injuries, or electric shock.



Don't

Do not expose the camera lens to direct sunlight for an extended period.

May cause fire, burns, injuries, etc. by the light-collecting mechanism of the lens.



Do

Turn off the terminal or put it in Airplane mode before boarding an airplane.

The use of mobile phones on airplanes is restricted. Follow the instructions of each airline.

Failure to do so may cause on-board electronic equipment to fail or malfunction.

Prohibited acts related to mobile phone usage on an airplane may be punished by law.



Do

Follow the instructions of each medical facility for the use of mobile phones on their premises.

Turn off the terminal in a place where the use is prohibited. Failure to do so may cause electronic equipment or electronic medical equipment to fail or malfunction.



Do

When using the handsfree call, ringtone is ringing loud, or in the standby mode, be sure to keep this terminal off of the ears.

Also, when playing games, video, or music with an earphone microphone connected to the terminal, adjust the volume to the proper level.

Loud sound is emitted from the terminal when calling with hands-free set.

Even in standby mode, a ringtone or an alarm sound may sound suddenly.

Setting too loud a volume or using the earphone continuously for a long period of time might adversely affect your ears. And, if you cannot hear the sound around you clearly, it may cause an accident.



Do

If you have weak heart, be careful when setting the incoming vibrate alert (vibration) or alert volume setting.

Failure to do so may cause harmful effect on heart.



Do

When you use electronic medical equipment, check with the equipment manufacturer to determine how the device is affected by radio waves before using.

Failure to do so may cause harmful effect on electronic medical equipment etc.



Do

Turn the terminal OFF near high-precision electronic control equipment or electronic equipment using low-power signals.

Failure to do so may cause the equipment to fail or malfunction.

* Examples of electronic equipment to avoid
Hearing aids, implanted pacemakers or defibrillators, other electronic medical equipment, and other automatic control equipment. Users wearing implanted pacemakers or defibrillators, or other electronic medical equipment should check with the manufacturer or sales outlet about the effect of radio frequencies on the equipment.



Do

When the display or camera lens is accidentally broken, be careful of broken glass or exposed internal parts of the terminal.

If you mistakenly touch broken or exposed parts, you may have burns, injuries, or electric shock.



Do

If the internal battery leaks or gives off a strange smell, immediately remove the terminal from the vicinity of open flames.

The vapors from leaking battery fluid may ignite, fire or explode.



Do

Be careful not to let your pet bite the terminal.

Failure to do so may cause the internal battery to ignite, burst, heat, or leak, resulting in fire, burns, or injuries.



CAUTION



Don't

Do not swing the terminal around by holding antenna cable, strap, etc.

May cause an accident such as injury to yourself or others, or damage to surrounding objects by hitting.



Don't

When using the motion sensor, check the safety around you, hold the terminal firmly, and do not shake it unnecessarily.

May cause accident such as injuries.



Don't

If the display breaks and the fluid etc. leaks out from inside, do not let the fluid contact with the skin on your face or hands or clothes.

May cause eye or skin problems.

If the fluid etc. enters your eyes or mouth, or contacts skin or clothes, immediately flush the contacted area with clean water.

If the fluid etc. enters your eyes or mouth, immediately see a doctor after flushing.



Don't

Do not discard the old terminal together with other garbage.

May cause ignition resulting in fire, burns, or injuries.

Also, may cause environmental destruction. Bring them to a sales outlet such as docomo Shop. If your local municipality has a battery recycling program, dispose of them as provided for.



Don't

If fluid etc. leaks out from the internal battery, do not let the fluid contact with the skin on your face or hands.

May cause eye or skin problems.

If the fluid etc. enters your eyes or mouth, or contacts skin or clothes, immediately flush the contacted area with clean water.

If the fluid etc. enters your eyes or mouth, immediately see a doctor after flushing.



Do

To use the terminal in car, check with automobile manufacturer or dealer to determine how the device is affected by radio waves before using.

In rare cases, using the phone in some vehicle models can cause the vehicle's electronic equipment to malfunction. In that case, stop using the terminal immediately.



Do

If you develop skin problems, stop using the terminal immediately, and see a doctor. The use of the terminal may cause itching, rashes, eczema, or other symptoms depending on the user's physical condition.

For materials of parts, refer to the following.

→P16"Material list"



Do

Make sure that there is no adhered metal pieces (cutter blade, staples, etc.) to the terminal because the part which is generating the magnetism is used for the out-camera part and the earpiece/speaker part.

Not doing so may cause injuries, etc. due to adhered objects.



Do

When watching the display screen, keep a certain distance from the display in a fully bright place.

Not doing so may reduce visual acuity.



Do

Stop the 1Seg antenna when not using 1Seg.

When you call etc. with the 1Seg antenna extended, it may cause accident such as injury to yourself or others by hitting.

◆ Handling the adapter



WARNING



Don't

Do not use the adapter cord if it gets damaged.

May cause fire, burns, electric shock.



Don't

Do not use the adapter in a bathroom or other highly humid area.

May cause fire, burns, electric shock.



Don't

Always use the DC adapter with a negative-ground vehicle. Do not plug it into a positive-ground vehicle.

May cause fire, burns, electric shock.



Don't

When it starts to thunder, do not touch adapter.

May cause electric shock.



Don't

Do not short the charging terminal while it is connected to an outlet or accessory socket. Do not touch the charging terminal with a part of your body such as your hand or finger.

May cause fire, burns, electric shock.



Don't

Do not place heavy objects on the adapter cord, or do not pull the cord with excessive force.

May cause fire, burns, electric shock.



Don't

When you insert and remove the AC adapter from power outlet, do not contact a metal strap or other metal objects with the jack.

May cause fire, burns, electric shock.



Don't

Do not use a transformer for overseas travel (travel converter) as the AC adapter.

May cause fire, heat, electric shock.



Don't

Do not put an excessive force up, down, left or right to the adapter connected to the terminal.

May cause fire, burns, injuries, electric shock.



No wet hands

Do not touch the adapter cord, charging terminal, or power plug with wet hands.

May cause fire, burns, electric shock.



Do

Only use with the specified power source and voltage. When charging the terminal overseas, use AC adapter for global use.

If incorrect voltage is used, this may cause fire, burns or electric shock.

AC adapter : 100V AC (Connect to the AC outlet for internal household use)

AC adapter for global use : Between 100V and 240V AC (Connect to the AC outlet for internal household use)

DC adapter : 12V or 24V DC (specific for negative ground vehicle)



Do

When replacing the DC adapter's fuse, replace it only with a specified fuse.

Replacing with a different type of fuse might cause fire, burns, electric shock, etc. For the specified fuse, see the provided instruction manual.



Do

Wipe off any dust that accumulates on the power plug.

Failure to do so may cause fire, burns or electric shock.



Do

When you connect the adapter to an outlet or accessory socket, firmly connect it to the outlet.

Failure to do so may cause fire, burns, electric shock.



Do

When you disconnect the power plug from an outlet or accessory socket, do not pull the adapter cord with excessive force. Instead, hold the adapter to disconnect.

Failure to do so may cause fire, burns, electric shock.



Do

When you remove or insert the adapter from/to the terminal, do not pull the adapter cord with excessive force. Instead, remove or insert the adapter straight.

Failure to do so may cause fire, burns, injuries, electric shock.



Do

Immediately stop using the terminal if the external connection jack is deformed. Do not use it by restoring the deformation.

Use of deformed charging jack may cause fire, burns, injuries, or electric shock due to short circuit of the charging terminal.



Unplug

Always remove the power plug of the adapter from an outlet or accessory socket when not using the adapter.

Failure to do so may cause fire, burns, or electric shock.



Unplug

Immediately remove the power plug from the outlet or accessory socket if water or other fluids (drinking water, perspiration, seawater, urine of pet animals, etc.) get into the adapter.

May cause fire, burns, electric shock.



Unplug

Always remove the power plug from an outlet or accessory socket when cleaning the equipment.

Not doing so may cause fire, burns, or electric shock.

CAUTION



Don't

Do not touch the adapters for a long time while they are connected to an outlet or accessory socket.

May cause burns.

◆ Handling the docomo nano UIM card

CAUTION



Do

Be careful of the cut surface when handling a docomo nano UIM card as it may damage a part of your body such as fingers, etc.

Failure to do so may cause injuries.

◆ Handling mobile phones near electronic medical equipment

WARNING



Do

Wearers of medical equipment such as implanted pacemakers or defibrillators must carry and use the terminal at least 15 cm away from the implanted device.

The terminal's signals may affect the performance of electronic medical equipment.



Do

When electronic medical equipment other than implanted pacemakers or defibrillators are in use outside of medical facilities (such as in home care settings), check with the device manufacturer to determine how the device is affected by electrical signals.

The terminal's signals may affect the performance of electronic medical equipment.



Do

Make sure that the terminal will not emit any signals (turn off power, put it in Airplane mode, etc.) if within 15 cm of those around you, such as where crowded and you cannot move freely.

There may be wearers of medical equipment such as implanted pacemakers or defibrillators around you. The terminal's signals may affect the performance of electronic medical equipment.



Do

When using the terminal in a medical facility, be sure to observe the regulations of the facility.

Not doing so may affect the performance of electronic medical equipment.

◆ Material list

■ F-05J Terminal

Part		Material/Surface treatment
Display panel		Hardened glass/AF coating
Exterior case	Top parts, Bottom parts	PC-GF resin/Acrylic UV curable coating
	Side parts	Aluminum/Anodized
1Seg antenna	Top	PC+ABS resin/Acrylic UV curable coating
	Pipe	Stainless steel/None
	Root bending part	Nickel titanium alloy/None
	Root rotating part (upper, lower)	Stainless steel/None
	Screws	SUS-XM7/None
Back panel		PMMA, PC composite/Hard court
Receiver mesh		Polyester/None
Light lens		PC resin/None
Power key, Volume key		PC resin/Acrylic UV curable coating
Slot cap		PC resin + Polyester elastomer resin + Silicon resin/Acrylic UV curing paint treatment
Stereo earphone jack		PA resin/None

Part	Material/Surface treatment
IMEI sheet (Sheet, Bar code)	PET/None
Tray for docomo nano UIM card	POM resin/None
External connection jack	Stainless steel/Tin plating

Handling precautions

◆ General

- **F-05J is waterproof/dustproof; however, do not allow water (drinking water, perspiration, seawater, urine of pet animals, etc.) or dust to enter this terminal or come in contact with optional accessories.**
 - The adapter and docomo nano UIM card do not have waterproof/dustproof function. Do not use them in places with high humidity such as a bath or where rain may get it wet. If you carry the terminal close to your body, moisture from sweat may corrode the internal parts causing a malfunction. Note that malfunctions deemed to be caused by water are not covered by the warranty or impossible to repair. For repairs, contact "Technical Inquiries & Repairs" (in Japanese only) on the last page of this manual or DOCOMO specified repair office.
- **Clean the terminal with a dry soft cloth (such as a cloth for eyeglasses).**
 - Rubbing it roughly with a dry cloth may scratch the display.
 - Drops of water or dirt left on the display may cause stains.
 - If the terminal is wiped with alcohol, paint thinner, benzine or detergent, the printing may disappear or color may fade.
- **Clean the jack occasionally with a dry cotton swab etc.**
 - If the jack etc. is dirt, you may not use the terminal normally.
Also, be careful never to damage the jack when cleaning it.

- **Do not place the terminal near an air-conditioner outlet.**
 - The rapid change in temperature may cause condensation, causing internal corrosion and malfunction.
- **Do not apply excessive force to the terminal.**
 - Putting the terminal into a tightly packed bag or sitting on the terminal in your pocket might damage the display or internal circuit board resulting in a malfunction. Also, keeping an external device connected to the external connection terminal might damage the connector resulting in a malfunction.
- **Use the optional products specified by NTT DOCOMO for your terminal.**
 - If you use optional products other than specified, it may cause malfunction or damage.
- **Read the instruction manuals supplied with individual optional devices.**
- **Do not drop the terminal or subject it to shocks.**
 - May cause malfunction or damage.

◆ The terminal

- **Do not press the display strongly, or not operate with a sharp-pointed objects.**
 - The display may be scratched and may cause malfunction or damage.
- **Avoid extreme temperature.**
 - Use the terminal where the temperature ranges between 5 and 40°C (limited to the temporary use in a bathroom etc. when temperature is above 36°C) and humidity ranges between 45 and 85%.
- **The terminal may affect land-line phones, TVs or radios in use nearby, so use it as far as possible from these appliances.**

- **Be sure to back up the data you saved in the terminal on a microSD card, PC or cloud service, or keep a separate note.**
 - If the data is deleted, DOCOMO assumes no responsibility for the loss of any data.
- **Do not plug external devices into the external connection jack at a slant, or do not pull it forcibly while it is plugged.**
 - May cause malfunction or damage.
- **It is normal for the terminal to become warm during use or charging. Continue to use it.**
- **Do not leave the lens of the camera under strong direct sunlight.**
 - May cause discoloring or burn-in of elements.
- **Use the terminal with the slot cap closed.**
 - Not doing so may cause malfunction due to entering foreign objects such as liquid like water (drinking water, perspiration, seawater, urine of pet animals, etc.) or dust to the terminal.
- **While microSD card is being used, do not take the card out or do not turn off the terminal.**
 - May cause data loss or malfunction.
- **Do not bring magnetic cards or magnetic objects close to the terminal.**
 - Magnetic data in cash cards, credit cards, telephone cards, floppy disks, etc. may be erased.
 - Also, bringing strong magnetism close may cause a malfunction of the terminal.
- **Do not decorate the terminal with a film or stickers.**
 - May cause an abnormal operation of the function using the proximity sensor.
 - For the position of the proximity sensor, refer to the following.
 - P29 "Part names and functions"
- **The internal battery is a consumable part and out of the warranty.**
 - The internal battery may swell as the battery life draws to a close depending on the usage conditions.
 - It is time to replace the internal battery when the usage time has become extremely short even though it has been fully charged or when the internal battery is swollen. For replacement of the internal battery, contact "Technical Inquiries & Repairs" (in Japanese only) on the last page of this manual or DOCOMO specified repair office.
- **Charge the battery in an area within the proper ambient temperature range (5-35°C).**
- **The operation time provided by the internal battery varies by the operating environment and internal battery deterioration.**
- **When storing the terminal, avoid the following conditions since they deteriorate the performance or the battery life of the internal battery.**
 - Storing under the state of the full charge (right after charging ends)
 - The battery has run out (the terminal cannot be turned on)

Approximately 40% of remaining battery level is recommended to store the terminal as a guide.
- **The terminal has the following type of internal battery.**

Display	Battery type
Li-ion 00	Li-ion battery

◆ Instructions for using the adapter

- Charge the battery in an area within the proper ambient temperature range (5-35°C).
- Do not charge the battery in the areas below.
 - In areas of excessive humidity, dust or vibrations
 - Near land-line phones or TV/radio
- It is normal for the adapter to become hot while charging. Continue to use it.
- When using the DC adapter for charging, keep the vehicle engine running.
 - The vehicle's battery could become flat.
- When using an outlet with a mechanism preventing unplugging, follow the handling instructions for that outlet.
- Do not give strong shock. Do not deform the charging jack.
 - May cause malfunction.

◆ docomo nano UIM card

- Do not use excessive force to install/remove docomo nano UIM card.
- Note that DOCOMO assumes no responsibility for malfunctions occurring as the result of inserting and using docomo nano UIM card with another IC card reader/writer.
- Always keep UIM IC's clean by cleaning occasionally.
 - If you use the docomo nano UIM card with the IC soiled, it may hinder properly operations.
- Clean docomo nano UIM card with a soft, dry cloth (such as a cloth for eyeglasses).

- Be sure to back up the data you saved in the docomo nano UIM card to the microSD card, a PC or a cloud service, or keep a separate note.
 - If the data is deleted, DOCOMO assumes no responsibility for the loss of any data.
- Take an expended docomo nano UIM card to a sales outlet such as a docomo Shop for proper disposal in order to protect the environment.
- Take care not to scratch, touch accidentally or short IC.
 - May cause data loss or malfunction.
- Do not drop a docomo nano UIM card or subject it to impact.
 - May cause malfunction.
- Do not bend a docomo nano UIM card or place a heavy object on it.
 - May cause malfunction.
- Do not install docomo nano UIM card into the terminal with a label or sticker put on.
 - May cause malfunction.

◆ Bluetooth function

- This terminal is equipped with the security features, that are compliant with Bluetooth standards for communication via Bluetooth. However, depending on the settings, there may not be enough security. Be aware of security risks when using Bluetooth.
- DOCOMO assumes no responsibility for any information which may be leaked during communication via Bluetooth.
- Frequency bands
Frequency bands used by the terminal Bluetooth function are as below.

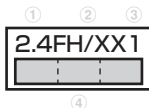

- ① 2.4 : Radio equipment that uses the 2400 MHz band.
- ② FH/XX : The modulation is the FH-SS method or other method (method other than DS-SS method/DS-FH method/FH-OFDM composite method/OFDM method).
- ③ 1 : The expected interference distance is 10 m or shorter.
- ④  : All bandwidths between 2400 MHz and 2483.5 MHz are used, and the bandwidth used by mobile object identification devices cannot be avoided.

Use of Bluetooth function is limited in some countries.

Confirm regulations of the country/region to use it.

To use in airplane, confirm with airline company in advance.

Cautions on using Bluetooth devices

In the bandwidth used by this terminal, in addition to home electric appliances such as a microwave oven and industrial/scientific/medical devices, in-plant radio stations used to identify mobile objects used in production lines of a factory that require a license, specified low power radio stations, or amateur radio stations that do not require a license (hereafter "other radio stations") can be in operation.

1. Before using the terminal, check whether "other radio stations" are in operation in your neighborhood.
2. If radio wave interference occurs between the terminal and "other radio stations", use the terminal in a different location or "Turn the power OFF" to avoid the radio wave interference.
3. For details, contact "General Inquiries" on the last page of this manual.

◆ Wireless LAN (WLAN)

- **Wireless LAN (WLAN) exchanges information using radio waves, and allows you to freely establish LAN connection if you are within an area where radio wave reaches. On the other side, if you communicate without appropriate security settings, communications may be intercepted or hacked by malicious parties. It is recommended to make necessary security settings on your judgment and responsibility.**

- **Wireless LAN**

Do not use wireless LAN in a place where magnetized by electric products, AV, OA equipment, etc. or where electromagnetic wave is generated.

- If magnetism or electrostatic noise affects the terminal, noise may be increased or communication may not be available (especially when using microwave oven, it may affect the terminal).
- Using near TV or radio may cause poor reception or TV screen may be blurred.
- When multiple wireless LAN access points exist near the terminal and they use the same channel, search may not be performed correctly.

- **Frequency bands**

Frequency bands used by the terminal wireless LAN function are as below.

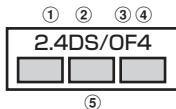

- ① 2.4 : Radio equipment that uses the 2400 MHz band.
- ② DS : The modulation is the DS-SS method.
- ③ OF : The modulation is the OFDM method.
- ④ 4 : The expected interference distance is 40 m or shorter.
- ⑤  : All bandwidths between 2400 MHz and 2483.5 MHz are used, and the bandwidth used by mobile object identification devices can be avoided.

Available channels vary by countries. To use WLAN overseas, check the conditions such as available frequency, regulation, etc. for the country.

To use in airplane, confirm with airline company in advance. When docomo nano UIM card is not inserted or when you are out of service area, channels 12, 13 of 2.4 GHz band and channels between 120 and 128 of 5 GHz band are not available regardless of whether you are in Japan or abroad.

Cautions on using 2.4 GHz devices

In the frequency band used by WLAN devices, in addition to home electric appliances such as a microwave oven and industrial/scientific/medical devices, in-plant radio stations for identification of mobile objects used in production lines of a factory (a license is required), specified low power radio stations (a license is not required), or amateur radio stations (a license is required) can be in operation.

1. Before using this device, confirm that in-plant radio stations for identification of mobile objects, specified low power radio stations or amateur radio stations are not in operation in your neighborhood.
2. If this device generates harmful radio wave interference against in-plant radio stations for identification of mobile objects, change the using frequency promptly or stop using wireless LAN function, and contact "General Inquiries" on the last page of this manual, then consult about treatment for prevention of the interference (for example, installation of partitions etc.).
3. If this device generates harmful radio wave interference against in-plant radio stations for identification of mobile objects or amateur radio stations, or if any trouble, contact "General Inquiries" on the last page of this manual.

Cautions on using 5 GHz devices

Using wireless LAN built-into the terminal in 5.2/5.3 GHz outside is prohibited by the Radio Law.

Channel numbers and frequency bands available in Japan are as follows.

- 5.2 GHz band : 5,180 to 5,240 MHz (36, 38, 40, 44, 46, 48 Ch)
- 5.3 GHz band : 5,260 to 5,320 MHz (52, 54, 56, 60, 62, 64 Ch)
- 5.6 GHz band : 5,500 to 5,700 MHz (100, 102, 104, 108, 110, 112, 116, 118, 120, 124, 126, 128, 132, 134, 136, 140 Ch)

◆ FeliCa and NFC reader/writer

- **FeliCa and NFC reader/writer and P2P function of the terminal uses weak waves requiring no licenses for radio stations.**
- **It uses 13.56 MHz frequency band. When using other reader/writer or P2P function in your surroundings, keep the terminal away sufficiently from them. Before using, confirm that there are no radio stations using the same frequency band nearby.**
- **To use in airplane, confirm with airline company in advance. Use is limited in some countries. Confirm regulations of the country/region to use it.**

◆ CAUTION

- **Do not use a remodeled terminal. Using a remodeled terminal violates the Radio Law/Telecommunications Business Act.**

The terminal is compliant with rules on the technical standard conformance of specified wireless equipment based on the Radio Law/Telecommunications Business Act, and as a proof of it, the "Technical Compliance Mark" is depicted on the electronic nameplate of the terminal. You can check the electronic nameplate in the terminal as follows.

From the Home screen, **[Settings]** → **[System]** → **[About phone]** → **[Auth]**

If you remodel the terminal by removing its screws, your certification of technical standard conformance becomes invalid.

Do not use the terminal with its certification of technical standard conformance invalid as it violates the Radio Law/Telecommunications Business Act.

- **Be careful when you use the terminal while driving a car etc.** There is a penalty for holding or using the terminal while driving. However, absolutely necessary cases such as rescue of a sick person or maintaining public's safety are exempted.
- **FeliCa and NFC reader/writer function of the terminal conforms to Japanese radio standards. If you use the function overseas, confirm regulations of the country/region beforehand.**
- **Do not alter the basic software.** Repairs may be refused as a modification of software.

Waterproofness/Dustproofness, shock resistance

F-05J has a waterproof equivalent to IPX5^{*1} and IPX8^{*2}, as well as a dustproof property equivalent to IP6X^{*3} on the condition that the slot cap is securely attached. Also, the terminal comprises the shock resistant structure which passed the test^{*4} in accordance with United States Military Standard.

- *1 IPX5 means that a phone keeps functioning after applying a jet flow of 12.5 L/min. from every direction from a distance of approximately 3 m for at least 3 minutes using water nozzle in 6.3 mm inner diameter.
- *2 For F-05J, IPX8 means that a phone keeps functioning after F-05J is slowly submerged to depth of 1.5 m in static tap water at room temperature, left there for 30 minutes and then taken out (Camera function cannot be used under water).
- *3 IP6X, a degree of protection, indicates that the phone can maintain its functionality to prevent dust particles from entering into the phone even when it has been shaken for 8 hours in an apparatus containing dust particles 75 μm or less in diameter.
- *4 Our drop test which is in accordance with MIL-STD-810G w/ Change1 Method 516.7-Shock established by the USA Department of Defense is implemented.

Waterproofness	Immersion	Immersion test at the depth of 1.5 meters for 30 minutes
	Wind and rain	Rain test with wind speed of 18 m/s for 30 minutes

Dustproofness	Dust test for 6 hours consecutively (dust concentration of $10 \pm 7 \text{ g/m}^3$, wind speed of 8.9 m/s)	
Shock resistance	Drop test from 1.22 meters height to plywood (lauan) in 26 directions	
Vibrating resistance	Vibration test for 3 hours (1 hour each in 3 directions)	
Solar radiation resistance	Solar radiation test for 24 hours consecutively (total $1,120 \text{ W/m}^2$)	
Dampproofness	High humidity test for 10 days consecutively (95% of humidity, $30\text{-}60^\circ\text{C}$)	
Thermal durability	Operation at high temperature	Operation environment : High temperature test at 60°C
	Storage at high temperature	Storage environment : High temperature test at 70°C
	Operation at low temperature	Operation environment : Low temperature test at -20°C
	Storage at low temperature	Storage environment : Low temperature test at -30°C
Low pressure durability	Storage at low pressure	Low pressure test for 1 hour consecutively (57.11 kPa /Approx. 4,572 m)
	Operation at low pressure	Low pressure test for 1 hour consecutively (57.11 kPa /Approx. 4,572 m)

Salt water durability	Salt water durability test for 96 hours consecutively (2 cycles of 24 hours spraying of 5% salt water and 24 hours drying)
-----------------------	--

Our tests which are in accordance with the procurement standard of 14 provisions established by the USA Department of Defense (MIL-STD-810G) are implemented: waterproof (immersion, wind and rain), dustproof, shock resistant, vibration resistance, solar radiation resistance, dampproof, thermal durability (operation at high temperature, storage at high temperature, operation at low temperature, storage at low temperature), low pressure durability (storage at low pressure, operation at low pressure), and salt water durability. Performance of the terminal is confirmed at under the test environment, it does not guarantee the operation of actual use in every situation. Also, it does not guarantee the non-damage and trouble-free.

❖ What you can do with waterproofness of F-05J

- You can use the terminal to talk or watch 1Seg without using an umbrella in the rain with a rainfall of about 20 mm per hour.
 - When your hands or the terminal are wet, avoid opening/closing the slot cap.
- The terminal can be washed with tap water at room temperature.
 - With holding the slot cap not to open, wash the terminal with tap water without rubbing hard.
 - Do not apply water flow stronger than allowed (→P23).
 - Do not use brush, sponge, soap, detergent, etc.
 - If mud or dirt has adhered to your terminal, shake it several times in tap water put in a washbowl or other container to rinse it off and then flush it with running water.
 - Drain water in the specified steps (→P27) after washing.
- You can use the terminal in a bathroom.
 - Do not immerse the terminal into a bathtub. Also, do not use the terminal in hot water. May cause malfunction. If you should fall the terminal into the bathtub, immediately pick it up to drain water in specified procedure (→P27).
 - Never put the terminal in hot spring water or water containing soap, detergent or bath powder. In case the terminal gets wet with water other than tap water, wash it in the procedure above.
 - You can use the terminal within 2 hours in a bathroom where the temperature ranges between 5 and 45°C and humidity ranges between 45 and 99%.

- Rapid temperature change may cause condensation. If you bring the terminal from a cold place to warm place such as a bathroom, wait until the terminal reaches the room temperature.
- Do not put hot water from a faucet or shower.

❖ To ensure waterproofness/dustproofness

To prevent water or dust from entering the terminal, be sure to observe the following points.

- When attaching or removing a docomo nano UIM card or microSD card, put your fingertip in the groove and pull open the slot cap in the directions indicated by the arrows (1). After use, press it in the direction indicated by the arrows (2, 3) and close the cap securely in the direction indicated by the arrows (4) while tracing it with a finger along. Ensure that there are no gaps between the slot cap and the body.

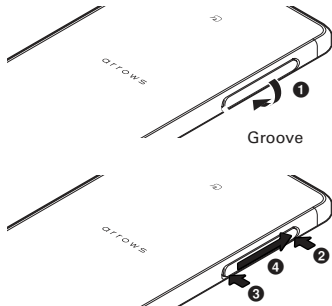

- Make sure to firmly close the slot cap. Even a fine obstacle (one hair, one grain of sand, tiny fiber, etc.) which is put between contact surfaces may allow water or dust to enter.
- Do not poke the stereo earphone jack, external connection terminal, mouthpiece/microphone, earpiece/speaker, back side microphone, slot cap, or other components with a sharp object.
- Do not let the terminal fall. Doing so may scratch the terminal, causing its waterproof/dustproof performance to degrade.
- Rubber seal in the slot cap plays an important part in waterproof/dustproof property. Do not damage or remove the rubber seals. Also, prevent dust from adhering to them.

It is recommended to replace the parts once every two years to maintain the waterproof/dustproof performance, regardless of whether an abnormality is present. Upon request, DOCOMO will replace the parts for a fee. Take your terminal to a sales outlet such as a DOCOMO-specified repair office.

◆ Important precautions

Do not perform actions shown in the illustrations below.

<Example>



Using Soap/Detergent/
Bath powder



Washing with
brush/sponge



Machine-washing



Applying strong
water flow



Soaking in
ocean water



Using in
hot spring

Observe the following precautions to use the terminal properly.

- The optional accessories are not waterproof/dustproof. Do not use the terminal with the AC adapter is connected to its external connection jack in a location exposed to water, such as a bathroom, shower room, kitchen, or lavatory.
- Do not apply water flow stronger than allowed (→P23). Even if the F-05J is waterproof in IPX5 waterproof, water may enter inside from a damaged section and cause troubles such as electric shocks or corrosion of the battery.
- If the terminal gets wet with salt water, sea water, refreshing beverage, etc. or mud or soil adhered, wash it immediately. If they dry out, it is hard to remove the dirt and it may cause damage or malfunction.
- Do not put the terminal in hot water, use it in a sauna or apply hot airflow (from a hair dryer etc.) to it.

- Do not move the terminal in water or slam the terminal against the surface of water.
- When you use the terminal in swimming pool, obey rules of the facility.
- The terminal does not float on water.
- Do not leave water drop on the terminal. In a cold region, may cause the water to freeze, resulting in a malfunction.
- Do not leave water drop on the stereo earphone jack, mouthpiece/microphone, earpiece/speaker, back side microphone. Such water may interfere with talking.
- Do not put water from a faucet directly to the external connection jack.
- Do not leave water drop on the external connection terminal.
- If the terminal gets wet with water or other liquids with the slot cap open, the liquid may get inside the terminal and cause electric shocks or malfunction. Stop using the terminal, turn the power OFF and contact a DOCOMO-specified repair office.
- If the rubber gasket of slot cap is damaged or deformed, replace it at DOCOMO-specified repair office.

DOCOMO does not guarantee actual operations under all states. Malfunctions deemed to be caused by inappropriate operation by the customer are not covered by the warranty.

◆ Draining water

When the terminal is wet, water may flow out after wiping it off; drain the water in the following steps.

- ① Hold the terminal firmly and wipe off moisture on the terminal surface and back side with dry, clean cloth etc.

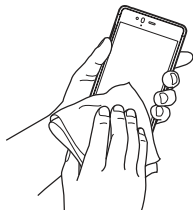

- ② Shake the terminal approximately 20 times, firmly holding it, until there is no more water splattering.

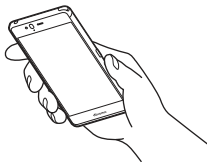

- ③ **Swing the terminal about 10 times against a dry, clean cloth etc. to wipe off any water remaining in the stereo earphone jack, external connection terminal, mouthpiece/microphone, earpiece/speaker, back side microphone, key, 1Seg antenna, etc.**

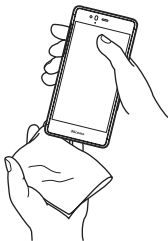

- ④ **Wipe off water drained from the terminal with dry, clean cloth etc., and dry naturally.**
- Water, if any, remaining in the terminal may ooze up after wiping off.
 - Do not wipe off the remaining moisture in the gaps directly with a cotton swab etc.

◆ Charging

Check the following during and after charging.

- Never try to charge the battery when the terminal is wet.
- When charging the battery after the terminal gets wet, adequately drain the terminal and then wipe off the remaining water with a dry, clean cloth or something similar.
- Check if water or a foreign object is in the external connection jack before use.
- Do not use the AC adapter in a bathroom, shower room, kitchen, lavatory or other highly humid area. May cause fire or electric shock.
- Do not touch the AC adapter with wet hands. May cause electric shock.

Before using the terminal

Part names and functions

Some illustrations omit the slot cap.

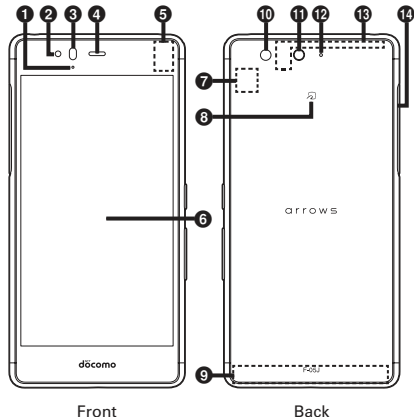

- 1 Indicator LED → P49
- 2 In-camera → P102

- 3 Proximity sensor/RGB sensor*¹
Proximity sensor detects approach of your face, prevents erroneous operation of the touch panel. RGB sensor senses ambient light and brightness and automatically adjusts the display backlight.
- 4 Earpiece/Speaker
- 5 GPS/Wi-Fi/Bluetooth antenna section*² → P113, P123, P164
- 6 Display (Touch panel)
- 7 Wi-Fi antenna section*²
- 8 ↻ mark → P94
- 9 LTE/FOMA antenna*²
- 10 Out-camera → P102
- 11 Flash/Light
- 12 Back side microphone
Use for reducing noise during a call. Do not cover it.
- 13 LTE antenna section*²
- 14 Slot cap*³

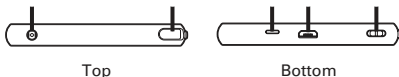

- 15 Stereo earphone jack (waterproof)
- 16 1Seg antenna*⁴ → P98
Extend when using 1Seg.
- 17 Mouthpiece/Microphone
- 18 External connection jack (waterproof)
Use for charging, PC connection, etc.
- 19 Strap hole

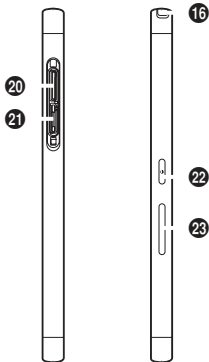

Left side Right side

20 microSD card slot

21 docomo nano UIM card slot

22 Power key  → P37, P53

Power on/off and set/cancel sleep mode.

23 Volume key

Adjust sound volume, or set/cancel Manner mode by pressing and holding volume down key for 1 second or more.

- *1 Putting a protective sheet or sticker on the sensor or covering the sensor with fingers may cause erroneous operation or incorrect sensing result.
- *2 It is built-in the terminal. Covering around the antenna by the hand may affect the quality.
- *3 Close the caps firmly to prevent water or dust from entering the terminal.
- *4 The terminal provides waterproof/dustproof capabilities even when the 1Seg antenna is extended.

■ Back cover

The back cover cannot be removed. Trying to remove it with excessive force may cause damage or malfunction.

docomo nano UIM card

A docomo nano UIM card is an IC card that stores user information, such as the users phone number.

- You can use the terminal only with a docomo nano UIM card. If you have a docomo mini UIM card, docomo UIM card, or FOMA card, bring it to a docomo Shop to replace it with a docomo nano UIM card.
- If docomo nano UIM card is not inserted to the terminal, some functions such as making/receiving calls and sending/receiving SMS are not available.
- For details on the docomo nano UIM card, refer to the docomo nano UIM card manual or NTT DOCOMO website.
- The slot of docomo nano UIM card is the inside of the slot cap.

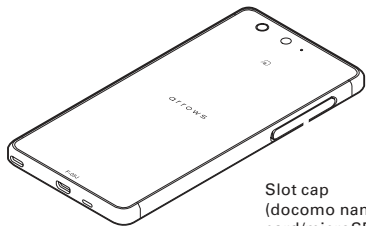

Slot cap
(docomo nano UIM
card/microSD card)

◆ Installing/Removing a docomo nano UIM card

- Install/remove after turning OFF the power.
- Be sure to use the tray when inserting a docomo nano UIM card. Failure to do so may cause a malfunction.

■ Installing

- ① Face down the display side of the terminal and open the slot cap hooking the groove with your fingertip (❶)
- ② Put your fingertip on the groove of the tray and pull it straight out (❷)
 - The tray is designed to be removed from the docomo nano UIM card slot.
- ③ With the IC side facing up, place the docomo nano UIM card on the tray (❸)
 - Check the orientation of docomo nano UIM card corner cut.
- ④ Make sure that the display side of the terminal is facing down, then insert the tray straight into the docomo nano UIM card slot (❹)

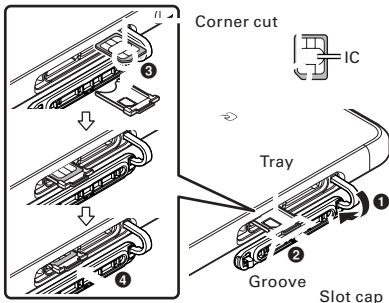

- ⑤ Press firmly the slot cap of the terminal to close → P25

■ Removing

- ① Face down the display side of the terminal and open the slot cap hooking the groove with your fingertip
- ② Put your fingertip on the groove of the tray, pull it straight out, then remove the docomo nano UIM card
- ③ Make sure that the display side of the terminal is facing down, then insert the tray straight into the docomo nano UIM card slot
- ④ Press firmly the slot cap of the terminal to close → P25

✓ INFORMATION

- When handling docomo nano UIM card, take care not to touch or scratch the IC. Also, be aware that trying to insert or remove the docomo nano UIM card using excessive force may cause it to break.
- For removing/inserting the tray from/into the docomo nano UIM card slot, do not remove or insert forcibly. Doing so may damage the tray.
- IMEI sheet with IMEI number and bar code printed is inserted under the docomo nano UIM card slot. Do not pull out the IMEI plate because it will be requested at a DOCOMO-specified repair office when the terminal is damaged etc. Also, please note the following.
 - If you pull out the IMEI sheet accidentally, insert it.
 - Do not pull out the IMEI sheet forcibly because it may cause damage.
 - If you lost the IMEI sheet, repairs may be refused.

◆ Security code for the docomo nano UIM card

You can set up a security code called a PIN code for your docomo nano UIM card. At the time of subscription, the code is set to "0000", which you can change by yourself. →P152

microSD card

◆ microSD card

- The terminal supports microSD card of up to 2 GB, microSDHC card and microSDHC UHS-I card of up to 32 GB, microSDXC card and microSDXC UHS-I card of up to 256 GB (as of May, 2017).
- Note that DOCOMO does not guarantee actual operations of all microSD cards. For information on compatible microSD cards, contact manufacturers of microSD cards.
- Do not turn off the power or give shock while accessing data on the microSD card. The data may corrupt.

✓INFORMATION

- A microSDXC card can be used only on a compatible device. Inserting a microSDXC card into a non-microSDXC-compatible device may damage or destroy data saved on the microSDXC card. Do not insert one. If you want to reuse a microSDXC card on which data is destroyed, format microSDXC card (all data will be erased) on an SDXC-compatible device.
- When copying data to/from a non-SDXC-compatible device, use a microSDHC card or microSD card complying with standards of device to share data.
- To use an application that uses large-size data such as video, etc. use a high-speed microSD card.
- The terminal supports up to Class 10 speed microSD card.
- The terminal supports up to UHS Class 3 speed microSD card.

◆ Installing/Removing microSD card

- Install/remove after unmounting microSD card (cancel recognition) (→P139) or turning off the power.

■ Installing

- ① Open the slot cap hooking the groove with your fingertip→ P25
- ② Check if the display side of the terminal is faced down and face down the metal contacts of microSD card, then insert into the microSD card slot until it clicks

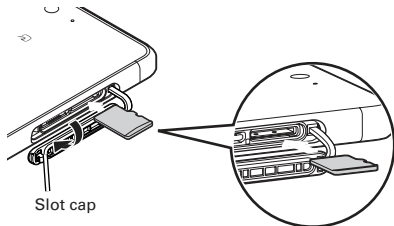

- ③ Press firmly the slot cap of the terminal to close→P25

■ Removing

- ① Open the slot cap hooking the groove with your fingertip→ P25
- ② Push the microSD card lightly and release it, then pull the microSD card straight out

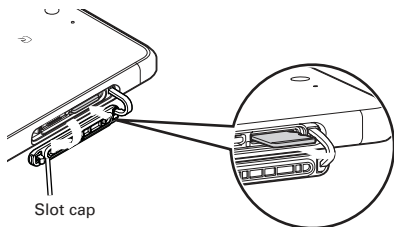

- ③ Press firmly the slot cap of the terminal to close→P25

✓INFORMATION

- Note that the microSD card may jump out of the terminal when removing it.

Charging

❖ Precautions on charging

- If you use applications while charging, it may take time to complete charging or charging may not complete due to drop-off of battery. To finish charging, end applications beforehand.
- It is normal for the terminal or AC adapter to become warm while charging. When the terminal becomes warm, charging may stop temporarily for the safety. When the terminal becomes extremely hot, stop using immediately.
- If the temperature of the internal battery or the terminal becomes out of range for charging, a charging error is notified and the indicator LED blinks or turns off. Wait until the temperature is dropped and then retry charging.
- If charging takes for very long time, a charging error is notified and the indicator LED turns off. Remove the terminal from the charger and retry.
- When power voltage of the internal battery is abnormal, charging error occurs and the indicator LED flashes. Immediately exit any applications you might be using. Remove the terminal from the charger and charge it again in the proper manner. If you still fail to charge the terminal properly, remove it from the charger, turn off the power, then contact "Technical Inquiries & Repairs" (in Japanese only) on the last page of this manual or a DOCOMO-specified repair office.
- When charging starts with the battery empty, the terminal may not be immediately activated after turning the power ON. In this case, charge the terminal while keeping it turned OFF, and turn it ON after a while.

- For charging time, see "Main specifications". →P190

❖ Internal battery life

- The internal battery is a consumable part. Each time it is charged, time available with each charging reduces. Talking on the phone for a long time while charging may reduce the internal battery lifetime.
- You can check performance (charging ability) of the internal battery from "About phone". →P161
- When the usage time becomes about half of a new battery, life of the internal battery is assumed to be over. We recommend you to replace the internal battery ahead of time. For replacement of the internal battery, contact "Technical Inquiries & Repairs" (in Japanese only) on the last page of this manual or DOCOMO specified repair office.



Li-ion 00

❖ Available charging adapter

For details, refer to the operation manual of AC adapter or DC adapter.

AC Adapter 05 (optional) : These adapters support 100V to 240V AC. The shape of AC adapter plug is for AC 100 V (Japanese specification). A conversion plug adapter for the destination country is required when using an AC adapter compatible from AC 100 V to 240 V. Also do not use a transformer for overseas travel to charge.

DC Adapter 04 (optional) : Used to charge in a car.

◆ Charging with AC adapter

Follow the procedure below to use AC Adapter 05 (optional) for charging.

- ① **With the side engraved with "B" facing up, insert the microUSB plug of the AC adapter horizontally into the external connection jack**
- ② **Insert the AC adapter's power plug into an outlet**
 - The indicator LED on the terminal lights up red while charging, and turns off when charging is complete.
 - The indicator LED on the AC adapter lights up green when the battery can be charged properly.
- ③ **When charging is complete, remove the AC adapter's power plug from the outlet**
- ④ **Remove the microUSB plug of the AC adapter horizontally from the external connection terminal of this terminal**

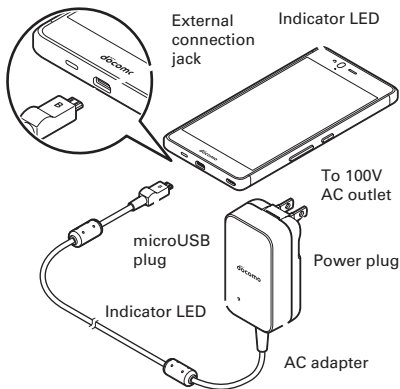

◆ Charging with a PC

You can charge the terminal via a PC using USB cable A to B 01 (optional) etc.

- When a screen of new hardware detection or operation selection appears on the PC, select [キャンセル (Cancel)].

Turning power on/off

◆ Turning power on

1 Press and hold (2 sec. or more) until the indicator LED lights in green

The terminal vibrates and the lock screen appears following the startup screen.

- For the first activation, make initial settings. →P47

2 Unlock the screen lock

- For unlocking method for screen lock, refer to "Unlocking screen lock". →P54

◆ Turning power off

1 Press and hold until the phone options menu appears

- In the options menu, the following items are displayed.
Power off : Turn the terminal OFF.
Restart : Restart the terminal.
Airplane mode : Turn the Airplane mode ON/OFF. →P128
Manner mode/Manner mode (Silent)/Manner mode (Alarm)/Original manner: Turn the Manner mode ON/OFF. →P137
Child proof : Enable Child proof. →P57
Emergency mode : Turn the Emergency mode ON/OFF. →P40

2 [Power off] → [OK]

The terminal turns off vibrating.

Basic operation

◆ Using touch panel

Touch the touch panel directly to operate the terminal.

❖ Notes for using the touch panel

The touch panel is designed for being touched lightly with fingers. Do not push it forcibly with a finger or press it with sharp objects (nail, ballpoint pen, pin, etc.).

- Touching the touch panel may not work in the following cases. Note that it may cause malfunction.
 - Operation with tip of fingernail
 - Operation with a foreign object on the display
 - Operation with protective sheet or seal on the display
 - Operation with the touch panel wet
 - Operation with finger wet by sweat or water
 - Operation under water

❖ Tap/Double-tap

Tap : Touch the screen lightly and release the finger quickly.

Double-tap : Tap twice quickly.



❖ Touch and hold

Touch the screen for a while. Some operations can be operated by keeping touching the screen with a finger.

❖ Drag/Slide (Swipe)/Pan

Drag : Touch an item or icon on the screen and move it to the desired position.

Slide (Swipe) : Touch the screen with your finger and drag to the desired position.

- For some applications, you can touch the screen with your fingers and move them up and down or rotate them to operate.

Pan : Drag the screen in a direction to view the desired part when whole web page etc. is not displayed in one screen.

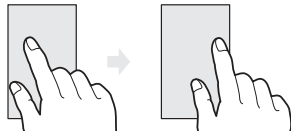

Example : Drag

❖ Pinch

Touch the screen with two fingers and widen (pinch-out) or narrow (pinch-in) the fingers distance.

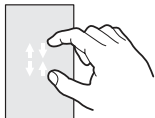

❖ Flick

Touch the screen and sweep the finger quickly.

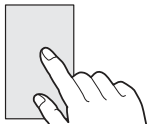

◆ Switching the portrait/landscape view

The terminal supports a motion sensor that senses orientation or motion of the terminal. You can switch display view by tilting the terminal vertical or horizontal (Auto-rotate screen→P133).

- Even when you change the orientation of the terminal, the screen may not change depending on the screen displayed.
- Lock the screen to the direction you look when it rotates automatically by changing your posture holding the terminal (Shake to unrotate→P134).

◆ Screenshot

You can save a screen displayed on the terminal as an image.

- Some screens may not be saved.

1 Press and hold and volume down key at the same time (1 sec. or more)

Screen shot is saved and  appears on the status bar.

- To check the image, flick the status bar downward to open the Notification panel (→P52), and tap a notification of screenshot→Select an application, or from the Home screen, [Gallery]→[Screenshots].

◆ Emergency mode

In case of emergency such as disaster, reduce the battery consumption by restricting the screen brightness or turning off functions.



1 Press and hold  until the phone options menu appears

2 [Emergency mode]→[OK]

The terminal restarts and Emergency mode is set.

- To cancel the setting, perform the same operations again or from the Home screen for Emergency mode, tap [Stop saving]→[OK].

✓INFORMATION

- Alternatively, from the Home screen, tap →[Disaster kit]→→[OK] for setting Emergency mode.
- In Emergency mode, the setting is not canceled by turning the power off.

◆ Application permissions

The first time you launch an application or function that accesses other functions and information on the terminal, a confirmation screen that requests authorization for access rights appears. When you approve these access rights, the corresponding functions and information become available to the application or function.

- Confirmation screens vary depending on the application or function. Check the displayed content carefully and operate.

<Example> When launching the "Gallery" app for the first time

1 From the Home screen, [Gallery]

The confirmation screen is displayed.

2 [DENY]/[ALLOW]

Follow the on-screen instructions.

✓INFORMATION

- If permission is not granted, some applications and functions may not work, or use of the functions may be limited.
- To change the permissions, from the Home screen, →[Settings]→[Display/Sound/Apps]→[Apps]→Tap the application→[Permissions]→Turn ON/OFF permissions to change.

Character entry

Enter characters using software keyboard displayed on the screen.

- Entering characters with Super ATOK ULTIAS is mainly described in this section.
- Switching to other input method is available.→P44
- You can connect an external keyboard to enter characters.→P47

◆ Using keyboard

You can enter characters using numeric keypad, QWERTY keypad or handwritten input.

- You can activate voice input from each keypad.→P42
- When the overwrite handwritten input option is enabled, handwritten input is available with the numeric or QWERTY keypad displayed.→P45

■ Numeric keypad

Multiple characters are assigned to a key.

- You can select input method from Flick input, Numeric keypad input, Gesture input or 2-touch input.→P43

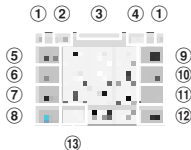

■ QWERTY keypad

Enter characters using Romaji input.

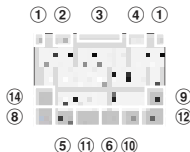

■ Handwritten input

Enter characters in handwriting.

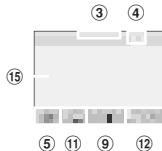

- Some key displays may be changed depending on the setting or condition.

- ① Drag left or right to adjust the width of the keypad
- ② Enable/disable Overwrite handwritten input
- ③ Drag up or down to adjust the height of the keypad
- ④ Display a list of number/symbol/smiley/pict/pict D
- ⑤  : Display menu

- When the menu is displayed, the following operations are available.

テンキー (Numeric keypad) : Switch to Numeric keypad

QWERTYキー (QWERTY keypad) : Switch to QWERTY keypad

手書き (Handwritten input) : Switch to handwritten input
全画面手書き (Handwritten in full-screen) : Switch to full-screen handwritten input

上書き手書き (Overwrite handwritten input) : Enable/disable overwrite handwritten input

定型文 (Common phrase) : Display common phrases

記号 (Symbol)・顔文字 (Smiley)・絵文字 (Pict) : Display a list of number/symbol/smiley/pict/pict D

テーマ切替 (Change theme) : Change the keyboard theme

引用アプリ (Quotation app) : 電話帳引用 (Quote phonebook) or Password manager

Tap [設定 (Settings)] to select an application that is activated by flicking key up.

設定 (Settings) : Setting for Super ATOK ULTIAS→P45

オススメ機能 (Recommended function) : Keyboard selection, Flick learning mode, ATOK Keyword Express

- Flick up to activate quotation app you set. Flick right to enter postal code→[変換 (Conversion)] to enter address corresponding to the postal code.

 (Touch and hold) : Activate voice input

 : Display characters assigned to a key in the reverse order

⑥ Move the cursor to left

- On the numeric keypad, flick up or down to move the cursor up or down, or flick right to move the cursor to the right.

On the QWERTY keypad, flick up to move the cursor up, or flick right to move the cursor down.

⑦ Display a list of number/symbol/smiley/pict/pict D

⑧ : Switch input mode to Kana/Alphabet

 : Switch input mode to Kana/Alphabet/Number

⑨ Backspace (Delete a character to the left of the cursor)

- After a character is fixed, flick a key up to delete the character on the right to the cursor and flick to the left to delete all characters on the left to the cursor.
- Flick down on the key to restore a character deleted after it was fixed (or flick right in handwritten input mode in portrait view).

⑩ Move the cursor to right

- On the numeric keypad, flick up or down to move the cursor up or down, or flick left to move the cursor to the left.
On the QWERTY keypad, flick up to move the cursor up, or flick left to move the cursor down.

⑪ : Enter space

- Flick up to enter a one-byte space in two-byte input mode, or a two-byte space in one-byte input mode.

 : Convert character

⑫ / : Fix or enter linefeed

 : Move the cursor to the next entry field

 : Search

 : Execute

⑬ : Convert to voiced/semi-voiced sound/small/geminate consonant characters



 : Switch uppercase and lowercase of alphabet

⑭ Switch uppercase and lowercase of alphabet

- Tapping this button switches the text case in this order: uppercase (the first letter of each word)→caps lock→lowercase.

- 15 Handwritten input area : Write a character with your finger to enter
- When you write a character, a recognized character appears on the top of input area. You can select a character from the correction candidate list displayed when a recognized character is tapped. You can rewrite on the correction candidate list.

✓INFORMATION

- To hide the keypad, tap . To show the keypad again, tap the character entry field.
- When you type and fix a word that is not on the list of candidates,  may appear in the area indicated by ②. Tap  to save the entered word to the personal dictionary.
- In the entry screen for the password etc., relate the entry screen to an ID (account) or password registered by Password manager to enter quotations.
Tap [Register to Password manager] on the upper part of the keyboard and register the authentication information to Password manager to relate to the entry screen. To enter quotations, tap [Quote from Password manager].
 - On the browser, ID and password will be automatically entered as the quotations according to the related screen information. However, ID and password may not be entered automatically as the quotation according to the screen layout.
 - In other applications, the items selected from the list screen will be entered as the quotations according to the related screen information.

❖ Numeric keypad input

You can use the following 4 input methods in the numeric keypad.

- Select the input method you want to use in [Numeric keypad]. →P45

■ Flick input

If you touch and hold the key assigned the character you want to enter, characters (flick guide) will be displayed on that key. Flick towards the desired character without releasing your finger from the screen.

- To enter voiced/semi-voiced sound/small/geminate consonant characters, tap  once or twice after flicking.

■ Numeric keypad input

Tap continuously a key assigned the character you want to enter until the desired character is displayed.

- To enter voiced/semi-voiced sound/small/geminate consonant characters, tap  once or twice after flicking.

■ Gesture input

If you touch and hold the key assigned the character you want to enter, characters (gesture guide) will be displayed around that key. Slide your finger to the desired character without releasing your finger from the screen.

- To enter voiced/semi-voiced sound/small/geminate consonant characters, slide down once or twice without releasing finger from a key. Gesture guide for voiced/semi-voiced sound/small/geminate consonant characters around the key appears. Slide your finger to the desired character without releasing.



Example: Entering "ぼ"

- In the alphanumeric input mode, you can switch between uppercase and lowercase characters by sliding downwards without releasing your finger from the screen.

■ 2-touch input

Tap a key assigned a character you want to enter first, then tap a desired character.

◆ Switching input method

You can also switch to another input method such as the Google keyboard to enter characters.

- The Google keyboard does not support the Japanese input mode.
- When you switch to "NX!input Chinese" or "NX!input Korean", you can enter characters only with handwritten input.

1 From the Home screen,  → [Settings] → [Languages & input]

2 [Current Keyboard] → Select an input method

- The keyboards displayed in the list of "Current Keyboard" can be set in [Manage keyboards] in "Setting character entry" (→P44).

✓ INFORMATION

- To return to the ATOK Japanese keypad, select [Japanese Super ATOK ULTIAS].
- To switch the input mode during entering characters, touch and hold  of the navigation bar (→P49) to select the input mode.

◆ Setting character entry

Set by character entries.

1 From the Home screen,  → [Settings] → [Languages & input]

2 [Virtual keyboard]

The list of the virtual keyboard is displayed.

3 [Google Keyboard]/[Google voice typing]/[Moji-Henshu]/[Super ATOK ULTIAS]/[NX!input Chinese]/[NX!input Korean]

- Tap [Manage keyboards] to set the keyboard displayed in the list screen of "Current Keyboard" or "Virtual keyboard".

4 Set required items

- Available items vary depending on input method.

❖ Setting Super ATOK ULTIAS

Set entry actions or design for each keyboard. Also, you can register words (Personal dictionary) or edit common phrases, initialize settings, etc.

1 From the Home screen,  → [Settings] → [Languages & input] → [Virtual keyboard] → [Super ATOK ULTIAS]

2 Set required items

ULTIAS Feature select : Set Keyboard selection, Flick learning mode, ATOK Keyword Express (Enable, Select genres, Notify updates, Receive right away, Auto receive, Interval, Auto receive on Wi-Fi only).

Operation sound/Vibrate : Set Keypad sound and Keypad vibration.

Numeric keypad : Set Input mode (Flick input/Numeric keypad input/Gesture input/2-touch input), Flick input (Flick guide, Flick Sensitivity, 「ㇿ」 key flick, Modifier key flick, Alphabet key flick), Multi-tap input, Auto cursor moving (Auto cursor moving, Time of auto cursor moving), Gesture input (Gesture guide, Gesture sensitivity, Around touch position, Show faster, Close faster, Time of gesture guide, 「ㇿ」 key gesture), Direct numeric input.

QWERTY keypad : Set Direct alphanumeric input, Show numeric keys (Vertical screen/Horizontal screen).

Handwritten input : Set Overwrite handwritten input (Numeric keypad, QWERTY keypad), normal handwriting or full screen handwriting of Number of input boxes (Vertical display/Horizontal display), Recognition speed (Auto confirm ON, Recognition speed), Set lines (Thickness and Color for NORMAL HANDWRITING/FULL SCREEN HANDWRITING).

Conversion setting : Set keyboard selection type for Hiragana/Alphabet/Numeric, Available keyboard, Select referred app of MENU flick, Input prediction, Showing prediction candidates before next input, Learning function, Use half-width space, Auto space insert, Character delete key, Function key flick guide, Back key, Auto full screen (horizontal), Hardware keyboard preferentially, Multi-touch.

- Prediction conversion candidates do not appear for character entry on some applications.
- Full screen may not be available depending on the application even if [Auto full screen (horizontal)] is enabled.

Set selection list : Set Font size, Number of lines to display (Vertical screen/Horizontal screen), Expression mode, Punctuation marks, Prediction correction, Proofreading support.

Design : Set Keyboard selection, Theme, Adjust keyboard height (Numeric keypad (Vertical display/Horizontal display), QWERTY (Vertical display/Horizontal display), Handwriting (Vertical display/Horizontal display)), Floating keyboard (Vertical screen/Horizontal screen).

- The floating keyboard is disabled in full screen even if [Horizontal screen] is enabled for [Floating keyboard].

Utility : Set Dictionary utility, Common phrase utility, ATOK Sync (Enable, Show shared words, Update right away, Auto update, Interval, Update on Wi-Fi only), Settings I/O (Export Settings, Import Settings).

Initialize : Initialize settings or Initializing learning data.

- Learned data, edited personal dictionary/common phrase are not deleted even if [Initializing settings] is executed.

Open source software license : Display the open source software license.

Super ATOK ULTIAS : Check the version of Super ATOK ULTIAS.

◆ Editing text

You can copy texts in the character entry field, web page, or received mail and cut and paste texts, register words in the character entry field.

- Operation method may vary by application.

❖ Copying/Cutting text or Registering words

■ Copying/Cutting/Registering words in the character entry field

1 Touch and hold a text

Selected text is highlighted.

- Drag knobs on the both ends of text range to adjust selected range.
- To select all, tap  [SELECT ALL].
- To deselect, tap out of selected range.

2 [COPY]/[CUT]

- To register words, tap  [REGISTER WORDS] and enter the pronunciation only and select the part of speech.

■ Copying text in a web page etc.

1 Touch and hold a text

Text range is highlighted.

- Drag knobs on the both ends of text range to adjust selected range.
- To select all, tap [SELECT ALL].
- To deselect, tap out of selected range.
- For some websites, you can perform operations such as tapping [Copy link text] from the menu displayed by touching and holding link.

2 [COPY]

✓ INFORMATION -----

- Touch and hold text and tap [SHARE] to send the selected text using an application.

❖ Pasting text

1 Tap a position to paste → [PASTE]

The text is pasted to the cursor position.

◆ Using external keyboard

You can connect a Bluetooth keyboard (HID/SPP) to the terminal to enter characters.

- 101 keyboard, 104 keyboard, 106 keyboard, OADG 109 keyboard and OADG 109A keyboard are supported.
- For connecting with Bluetooth keyboard, refer to "Connecting with registered Bluetooth devices". →P165

❖ Setting external keyboard

- A keyboard is displayed when the external keyboard is connected.

- 1 From the Home screen,  → [Settings] → [Languages & input]
- 2 [Physical keyboard] → Select a keyboard → Select a keyboard layout

❖ Displaying the virtual keyboard

You can set whether to display the software keyboard when an external keyboard is connected.

- 1 From the Home screen,  → [Settings] → [Languages & input]
- 2 [Physical keyboard] → Tap [Show virtual keyboard] to set to ON/OFF

❖ Displaying the shortcut of the keyboard

Display the shortcuts to use a connected external keyboard.

- 1 From the Home screen,  → [Settings] → [Languages & input]
- 2 [Physical keyboard] → [Keyboard shortcuts helper]

Initial settings

When you turn on the terminal for the first time, make initial settings following the onscreen instructions.

- Depending on Google account settings, indicated items may vary.
- 1 Tap [日本語(日本) (Japanese)] and select [English] → [United States] and then [LET'S GO]
 - From here on, follow the onscreen instructions to set.
 - Select set up method
 - Wi-Fi
 - Google account
 - Protect your phone
 - Google services
 - 2 Mark [Agree to all] in the initial settings screen for docomo services → [NEXT]

3 Set each item → [NEXT]

d ACCOUNT : Set d ACCOUNT for using in docomo apps.

docomo cloud : Set services for docomo cloud.

Install all apps : Install applications necessary for using docomo services you subscribed all at once.

4 In Anything else? screen, set each item → [ALL SET]

The Home screen appears.

✓INFORMATION

- When How to use the Home screen appears, confirm the content and then tap [Next] → [Next] → [Do not show again]/[OK].
- When a confirmation screen for sending terminal error information appears, tap [OK].
- If a software update confirmation screen appears, tap [OK].

❖ Easy data transfer support

Move mobile phone data (FOMA terminals manufactured by Fujitsu/TOSHIBA) saved on a microSD card to the terminal.

- Move data of phonebook, redialing/incoming history, schedule, bookmark, received/sent/unsent mails.

1 From the Home screen, → [Settings] → [Location/Accounts] → [Backup & reset] → [Easy data transfer support]

Check guidance for each data moving location and tap [OK]. From here on, follow the onscreen instructions.

- If you do not want to display a guidance for moving location next time, mark [Don't display this screen again.] before tapping [OK].

✓INFORMATION

- Call history is overwritten to redial/received call history in the original location. Call history saved to the terminal before data transfer is deleted.
- To view moved received/sent/unsent mails, from the Home screen, tap  → [More] → [Import mail] and select the location.
- To display the moved schedule, synchronize with the account on the moved location. The last registered Google account is set as an account to move to.
- Since some FOMA terminals manufactured by Fujitsu/TOSHIBA do not support Easy data transfer support, data cannot be transferred.

Indicator LED

Indicator LED notifies the terminal states such as charging and missed call by lighting or flashing.

■ Main notification type, lighting/flashing

Turning on the terminal : Light once in green

Charging : Light in red

Charging error : Flash in red

New SMS : Flash in the color specified in "Messaging"→P82

Missed call, phone memo : Set the lighting color from [Missed call LED] in [ADVANCED] of [Notifications]→P135

✓INFORMATION

- Setting and action of indicator LED may vary by application.
- For lighting/blinking of indicator LED, Illumination setting comes first. For some applications it may work according to the settings of application. However, this function comes first when turning on the terminal.
- If the terminal is taken out from the charger when charging with the terminal turned off, turning off the indicator LED may take time.
- Depending on the notification contents, the indicator LED lights only when in the sleep mode.

Screen/Icon

◆ Icons on Navigation bar

Operation icons appear on the navigation bar shown at the bottom of the screen. Names and actions of icons are as follows.



■ Back icon

Tap : Return to the previous screen, exit out of application

■ Home icon

Tap : Return to the Home screen→P58

Touch and hold : Activate Google

■ History icon

Tap : Display recently used applications→P56











■ / ■ Slide display icon

Tap : Move the whole screen to the direction of the navigation bar/return to the original view→P50

◆ Slide display

When you hold the terminal in one hand, you can move the whole screen to the direction of the navigation bar to operate on the screen where your finger did not reach to.

Tap  to display the whole screen with it moved to the direction of the navigation bar (Slide display).







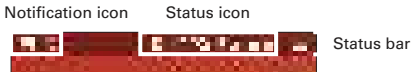













- In horizontal screen, tapping  moves the whole screen toward the navigation bar. However, the status bar will not move.
- While the slide display is displayed, tap  /  /  to move the screen left/right or up/down.
- Adjust range of sliding by dragging a free area in the slide display in the direction of an arrow.
- The screen returns to the original position by the following operations.
 - While the slide display is displayed, tap  /  /  / 
 - Switching from vertical screen to horizontal screen, or from horizontal screen to vertical screen
 - When a call is received, or an application which can be operated in full-screen is displayed
 - Displaying the screen again after it is switched to sleep mode
 - Displaying the keyboard for character entry
- To set to show/hide slide display icons, while slide display is displayed, tap  or from the Home screen, tap  → [Settings] → [Useful tools] → [Slide display].
- For some screens such as during screen lock or when the screen saver is activated, sliding is not available.











◆ Icons on the status bar

The status bar along the top of the screen shows notification icons and status icons that allow you to check various conditions.







































■ Main notification icon

-  : New Gmail → P82
-  : New NX! Mail → P83
-  : New docomo mail → P80
-  : New SMS → P80
-  : New Area Mail → P86
-  : Sending SMS is failed → P80
-  : Wi-Fi is on, and Wi-Fi network is → P123
-  : Wi-Fi tethering is enabled → P129
-  : USB tethering is enabled → P129
-  : Bluetooth tethering is enabled → P130
-  : More than two tethering features are enabled → P129
-  : Missed call → P72
-  : Phone memo exists → P73
-  : Message in Voicemail service → P73
-  /  : Uploading data is completed/Downloading data is completed
-  : Installing applications from Google Play etc. is completed → P92
-  : Update of application from Google Play is available → P92
-  : 3.5 earphone is connected
-  : Notification of watching or reserving 1Seg as background → P97

-  : Notification of docomo Data Copy→P119
-  : Software update→P187
-  : Screenshot image is saved→P39
-  : Immediately after you reoriented the screen using the Shake to unrotate function, you shook the terminal twice to restore the original orientation→P134
-  : Location providing is ON→P142
-  : Omakase Lock is set
-  : Available memory on the terminal is low
-  : Check for application battery (Detect applications that consumes battery power)
-  : Error/alert message
-  : Authentication failure of d ACCOUNT setting→P142
-  : Some notifications are not displayed

Main status icon

-  : Signal strength
-  : Out of service area
-  : During international roaming
-  : 4G (LTE)/3G/GSM available
 - △ (Uploading) or ▽ (Downloading) appears in white during communication
-  : Airplane mode is set→P128
-  : Wi-Fi is connected→P123
 - △ (Uploading) or ▽ (Downloading) appears in white during communication
-  : Multi-connection is enabled→P125
-  : Bluetooth function is ON→P165
-  : Bluetooth device is connected→P165
-  : NFC/Osaifu-Keitai lock is set→P96
-  : Omakase Lock is set
-  : Phone memo is set→P73
-  : Speaker phone is ON→P71
-  : Microphone is muted→P71

-  : Vibrator is ON→P136
-  : [Do not disturb*] is set to [Alarms only] or [Priority only]
-  : [Do not disturb*] is set to [Total silence]
- * Can be set with the panel switch. To use this function, add [Do not disturb] to the Panel switch in advance→P53
-  : Positioning with GPS→P114
-  : Manner mode (Manner mode)→P137
-  : Manner mode (Manner mode (Silent))→P137
-  : Manner mode (Manner mode (Alarm))→P137
-  : Manner mode (Original manner)→P137
-  : Remaining battery is 0 - 15%*
-  : Remaining battery is 16 - 28%*
-  : Remaining battery is 29 - 100%*
- * Battery indicator of the icon changes according to remaining battery level.
-  : Charging→P35
-  (white) : Keep lit when held is set (screen is lit detecting motion)→P134
-  (gray) : Keep lit when held is set→P134
-  : Glove touch is ON→P158
-  : VPN connection→P130
-  : No docomo nano UIM card
-  : Kana input mode→P41
-  : Alphabet input mode→P41
-  : Number input mode→P41
-  : Handwritten input mode→P41
-  : Number/symbol/smily/pict, common phrase input→P41

◆ Notification panel

Flick the status bar downward to open the Notification panel. In Notification panel, you can check information of notification icon or make settings.

1 Flick the status bar downward



① Settings

Display the settings menu. →P122

② Open the Panel switch

Display the hidden panel switches. →P53

③ Panel switch

- A part of the Panel switches is displayed. →P53
- Tap the Panel switch to switch ON/OFF of the function or setting.
- Flick the Panel switch downward to display the hidden panel switches.

④ Notifications

- Tap each notification to check the details or make necessary settings.
- Touch and hold the notification, or slide left or right and then tap  to make settings of Notifications.

⑤ CLEAR ALL

Clear the all notifications and close the Notification panel. Some notifications may not be cleared depending on notification content, or [CLEAR ALL] may not be displayed.

✓INFORMATION

- To close the Notification panel, flick the Notification panel upward or tap  (Back).
- Tap [CALL] or [SEND SMS] displayed below the missed call notification to dial or send SMS. However, when there are 2 or more missed calls, they do not appear.

◆ Panel switch

Flick the status bar downward with two fingers to open the Panel switch. Tap the panel switch item to switch ON/OFF of the function or setting.

1 Flick the status bar downward with two fingers

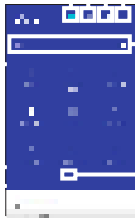

① User

Add or switch user/guest. →P140

② Edit

Touch and hold the panel switch and then drag it to delete or add. To reset the edited content,  in the edit screen → [Reset].

③ Settings

Display the settings menu. →P122

④ Close the Panel switch



Close the Panel switch and display the Notification panel. → P52

⑤ Panel switches

Tap each panel switch to ON/OFF of the function or setting. Touch and hold the panel switch to open the corresponding setting menu.

⑥ Notification →P52

⑦ Screen brightness level

Slide the slider to adjust the brightness. Tap  /  to cancel/set the auto adjustment according to the ambient brightness.

⑧ Indicator

Indicates the number of Panel switch pages and the which page you are in.

✓INFORMATION

- To close the Panel switch, flick the Panel switch upward or tap  (Back).
- ON/OFF operation of NFC in the Panel switch is unavailable while charging because the NFC is disabled.

◆ Sleep mode

When the sleep mode is set, the screen backlight turns off so that you can avoid misoperations of the touch panel and lock the screen. You can also reduce battery consumption.

1

✓INFORMATION

- When no operation is performed in a certain period of time, the screen automatically turns off according to the settings of [Screen timeout] (→P134) and the terminal turns into sleep mode.
- When receiving a call in sleep mode, sleep mode is deactivated.

◆ Unlocking screen lock



1 During sleep mode, 

2 On the screen, tap 

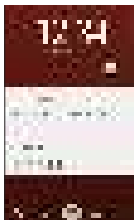
The lock is canceled.



*ひつじのしつじくん® (Butler Sheep)
©NTT DOCOMO

- Depending on the setting of [Security unlock preference] (→P145), authentication is required after swiping on the lock screen.
- Tap  on the lock screen to activate the camera.
- Tap  on the lock screen to activate the シャベってコンシェル (Shabette concier).

✓INFORMATION

- By default, numbers of missed calls and unread docomo mails are shown even when lock screen is displayed.
- By default, the lock screen goes into the sleep mode after approximately 10 seconds.

◆ Slide-in function

By default, you can call out Slide-in launcher and Capture & Draw/Highlight & Copy by sliding your finger from the slide spot (start point for sliding) at the corner of the screen.

- For information about the settings of the Slide-in function, refer to "Slide-in function".→P158

◆ Slide-in launcher

Activate an application from a shortcut saved in Slide-in launcher.

1 Slide your finger from the slide spot to the center of the screen, then release the finger at a shortcut in Slide-in launcher

- By default, Slide-in launcher is set in the slide spot at the lower left of the screen.
- You can set the Slide-in function by releasing your finger at the position of , which is called up at the same time as the Slide-in launcher.

2 Perform target operations

❖ Capture & Draw

Capture displayed screen to edit as an image or share with other application.

- Some screens may not be captured.

1 Slide your finger from the slide spot to the center of the screen, then release the finger in [Capture & Draw] area

- By default, Capture & Draw/Highlight & Copy are set in the slide spot at the lower right of the screen.

2 Select operation

Editing image : Tap tools to edit → [Save]

- Images can be viewed in Gallery (→P110) etc.
- With drawing tools, you can write texts or draw pictures on an image by handwriting, crop or zoom in/out.

Sharing with another application : [Share] → Select an application → Follow the onscreen instructions

- You can also activate an application by tapping an app icon displayed next to [Share].

✓ INFORMATION

- In case you capture a web page while using the browser, URL information is also obtained. To set whether to paste URL information when sharing, operate from the image editing screen, tap  → [URL sharing setting].

❖ Highlight & Copy

Text strings selected by tracing on the screen with your finger can be copied or shared with another application.

1 Slide your finger from the slide spot to the center of the screen, then release the finger in [Highlight & Copy] area

- By default, Capture & Draw/Highlight & Copy are set in the slide spot at the lower right of the screen.



2 Trace text strings you want to copy with your finger

Recognized texts are marked and displayed in preview.

- Tap the preview to display the keyboard to edit the texts.
- Some selected texts or background images are not recognized properly.

3 Perform required operations

Copying texts : [COPY]

- Tap  /  to display/hide preview. Tap [CLEAR] to cancel selecting texts.

Sharing with another application : Select an application to paste

- Displayed applications differ depending on the selected texts.

◆ Customizing screen

The color of the navigation bar, battery icon and keyboard design can be changed.

1 From the Home screen, tap [Settings] → [Display/Sound/Apps] → [Display & Wallpaper] → [Customize screen]

2 Set required items

Task manager

If you stop operation of an application by tapping [Home] etc., the application may remain active in the background. Also, 2 or more applications may be running depending on the operations. This function allows you to check running applications, switch display, or end applications.

1 [History]

The recently used applications appear.

- Tap a thumbnail to display an application.
- Flick a thumbnail left or right or tap [X] to end an application. To end all applications, tap [Delete all].

✓INFORMATION

- Set to show/hide recently used applications. → P151

Split screen

Split screen into two and you can operate two different applications in each screen at the same time.

- Activate applications to display in advance.
- The application which is not compatible with the split screen cannot be displayed with this function.

1 [History]

The recently used applications appear.

2 Touch and hold the application thumbnail, and then drag to the [Drag here to use split screen] appeared at the top of screen.





- When "App doesn't support split screen" appears at the top of the screen, the application cannot be displayed in this function.

3 Tap the thumbnail of application from the lower part of the screen

- If the desired thumbnail of application is not displayed, tap [Home] and activate the application.

✓INFORMATION

- The application windows in the split screen can be displayed up and down in the portrait view and left and right in the landscape view.
- In the lower part of the screen (right in the landscape view), the displayed application can be switched to another one. To switch applications, tap [Home] and select a thumbnail of the application, or tap [Home] and activate an application to display.

- To end the split screen, drag  in the center of the screen to the upper part or lower part of the screen (left end or right end in the landscape view), or touch and hold .
- When  is displayed in the navigation bar, the split screen keeps functioning. When an application is displayed in full-screen, tap  to return to the split screen.

Switching the home applications

Change the screen (Home screen) displayed by tapping  (Home). "docomo LIVE UX", "NX!Home" and "NX!Home Simple" home apps are available in the terminal.

- 1 From the Home screen,  → [Settings] → [Display/Sound/Apps] → [Display & Wallpaper] → [Homescreen selector]

2 Select a home application to switch to

✓INFORMATION -----

- The wallpaper for the lock screen may be changed by switching the home application depending the home application.

Child proof

Set the screen not to react by touch operation.

- 1 Press and hold  until the phone options menu appears

2 [Child proof] → [OK]

- To cancel the settings, press  for 1 second or more.

✓INFORMATION -----

- When Child proof is set, the terminal does not go into the sleep mode by pressing  or no operation in a certain period of time.

Home screen

On the Home screen, you can add widgets or activate applications. Flick left or right to switch pages on the Home screen.



- 1 Widget**
Activate widget (Google™ Search).
- 2 Machi-Chara**
Display information such as incoming call and mail reception.
- 3 Applications**
Activate applications.
- 4 Indicator**
Indicates the page number of home screens and which screen you are in.

- 5 Dock**
Displayed even if the home screen page is changed.
■ Apps button : Display the application list screen. →P60
■ My Magazine button : Display My Magazine. →P65
- 6 Customize area**
You can locate applications, widgets, and folders.
- 7 Folder**
Store multiple applications.

◆ Customizing the Home screen

You can locate desired applications, widgets, etc., or create folders to manage applications on the Home screen.

- Applications are located on either Home screen or the application list screen.
- Touch and hold the application, widget or folder located on the Home screen and drag it to change the position.





1 Touch and hold blank area in the customize area

2 [Show apps]/[Show widgets]/[Create folder]

3 Select items or make settings as required

- To move an application or add a widget to the Home screen, touch and hold an icon in the application/widget list screen, then drag it to the Home screen area at the bottom of the screen.
- To rename folder, select a folder and tap the folder name.
- Alternatively, touch and hold an application and drag it over another application to create a folder.
- Some widgets can be changed in its size by touching and holding.

✓ INFORMATION -----

- Applications and folders can be allocated in the dock (→P58) area. However,  cannot be moved/deleted/changed. To show/hide  on the Home screen, from the Home screen, tap  →  → [My Magazine use setting].

❖ Removing applications/widgets from the Home screen

1 Touch and hold an application/widget to remove

2 Drag to [Back to apps list]/[Remove from Home]

- Applications are moved to the application list screen (→ P60).

Disabling applications or widgets : Touch and hold an application or widget and drag it to [Disable app] → [DISABLE] → [DISABLE]

✓ INFORMATION -----

- If [Uninstall] appears when you touch and hold an application, drag the application to [Uninstall] and tap [OK] to uninstall.





◆ Changing Kisekae/Wallpaper

1 Touch and hold blank area in the customize area

2 [Change Kisekae]/[Change wallpaper]

3 Select items or make settings

✓ INFORMATION -----

- Alternatively, from the Home screen, tap  →  → [Kisekae]. Also, from the Home screen, tap  → [Wallpapers] → [Change Kisekae].
- For changing the wallpaper, from the Home screen,  → [Settings] → [Display/Sound/Apps] → [Display & Wallpaper] → Tap [Wallpaper] and select from the displayed items.
- The navigation bar and battery icons can also be changed. → P56

◆ Setting Machi-Chara

You can change the character display, character moving, balloon display and auto-update setting of character etc.

1 Touch and hold blank area in the customize area

2 [Machi-Chara setting]

3 Set required items

◆ Adding/Deleting home screen

Up to 7 home screens can be set.

1 Touch and hold blank area in the customize area

2 [Home screens]

3 Perform required operations

Adding : [+]



Sorting : Touch and hold a thumbnail of home screen and drag to the position you want move to

Deleting : [X]

- If applications or widgets are located, a deletion confirmation screen appears.

Displaying : Tap a thumbnail of home screen

✓INFORMATION

- Alternatively, from the Home screen, tap  →  → [Home screens]. Or, pinch-in at any position on the Home screen to display the home screens.

Application list

Display the application list to activate registered applications or move applications or widgets to the Home screen.

- Applications not located in the application list screen are displayed on the Home screen.
- You can check the functions and operation steps from Help for some applications.

1 From the Home screen, 

- For the first activation, the instruction guide appears. Tap [Do not show again] or [OK].
- Alternatively, flick downward on the Home screen to display the application list screen.

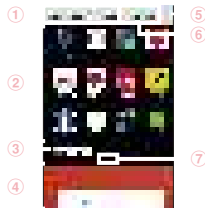















- ① Apps/Widgets/Wallpapers switch tab
- ② Apps/Widgets/Wallpapers (displayed respectively)
 - Flick left or right to select or set.
 - Depending on the application, number of unread messages appears on the icon.

- To move an application or add a widget to the Home screen, touch and hold an application/widget, then drag it to the Home screen area.
- ③ **Display all apps button**→P64
 - ④ **Home screen area**
 - Flick left or right to switch pages on the Home screen.
 - Flick up or tap to display the Home screen.
 - ⑤ **Options menu**
The options menu such as Kisekai, settings, etc. are displayed.
 - ⑥ **Recommends button**
You can install applications recommended by DOCOMO.→P64
 - ⑦ **Indicator (appears in each tab)**
Indicates the page number of the list screen and which screen you are in.

✓INFORMATION

- In the application list screen, tap →[Help] to check docomo LIVE UX operation guide.

◆ Pre-installed applications

-  **@Fケータイ応援団 (@F mobile phone supporters)** : Access @Fケータイ応援団 (@F mobile phone supporters) website.
-  **Amazon Kindle** : An application for reading books, comics, and magazines sold in the Kindle Store.
-  **Amazon Shopping** : An official application that allows comfortable shopping at Amazon with the smartphone-optimized view.
-  **Chrome** : View web pages like on a PC.
-  **Duo** : Allows you to enjoy one-to one video calls. You can share any moments with your important persons.
-  **dポイント (d POINT)** : An application for confirming, collecting or using d points.
-  **dmarket** : Various services including selling digital contents such as music, videos, books, shopping sites, travel reservation sites, etc. are provided. →P92
-  **dメニュー (dmenu)** : An application shortcut for "dmenu". You can easily access sites recommended by DOCOMO or convenient applications.→P92
-  **Excel** : The Microsoft Excel application for Android™.
-  **Facebook** : Facebook is a social service that allows users to communicate with friends, family, colleagues, and classmates and see what is happening in the world today.
-  **Gmail** : You can use email provided by Google or other general providers. →P82
-  **Google** : Search for the terminal or web pages. →P118
-  **iDアプリ (iD application)** : An application for using electronic money "iD" provided by DOCOMO. You can enjoy shopping only by holding Osaifu-Keitai with "iD" set over an IC card reader in stores.→P96
-  **Instagram** : This application enables you to edit the photos and videos taken by the terminal, and also can be shared with family, friends, and people all over the world.

iコンシェル (i-concier) : i-concier is a service with which a mobile phone supports your life like a "butler" or "conciere". This application delivers useful information for daily life such as nimbus alarm, train service information or outing spot depending on your schedule, area where you live, or your current location.

KSfilemanager : An application for managing data contents in the terminal, microSD card, etc. →P162

LAWSON : The official application of LAWSON. You can display digital membership using your mobile phone as a member's card, search shops, and find valuable exchange coupons.

McDonald's : The official application of McDonald's. An application for collecting coupons or latest information.

Messenger : Send messages or make calls or video calls to the contact of the mobile phone or the friend/group of Facebook.

My Tracker : You can record and check the daily steps, activity amount, and sleep log etc.

NX! Mail : Configure and manage multiple accounts of docomo mail, Gmail, and Internet mail. →P83

OneDrive : The Microsoft OneDrive application for Android.

OneNote : The Microsoft OneNote application for Android.

Play Music : Play music.

Play Store : Use Google Play. →P92

Play Movies & TV : Rent movies to watch. You can download movies to watch anytime you want.

PowerPoint : The Microsoft PowerPoint application for Android.

Twitter : An official client application of Twitter. Public short messages on the website to communicate with others.

ULTIAS feature select : Set Keyboard selection, Flick learning mode, ATOK Keyword Express (Enable, Select genres, Notify updates, Receive right away, Auto receive, Interval, Auto receive on Wi-Fi only).

Word : The Microsoft Word application for Android.

YouTube : You can play YouTube™ video.

Anshin Scan : Ensure your smartphone by checking virus, applications which require your personal data, by alerting when you attempt to access a non-secure website, etc.

遠隔サポート (Enkaku support) : Application for using "Anshin Enkaku Support". "Anshin Enkaku Support" is a service that allows staff of the Call center to support the terminal operations by remote-checking the display of your own terminal. →P184

Osaifu-Keitai : Pay money etc. only by holding the terminal over the IC card reader in stores etc. →P94

Voice Search : Just speak to the terminal to use Google Search. →P119

Camera : Shoot still images or videos. →P102

Calendar : View calendar and register schedule.

Gallery : View/play still images/videos shot by the camera or downloaded to the terminal. →P110

Disaster kit : An application for using Disaster Message Board, Disaster Voice Messaging Service and Early Warning "Area Mail". →P86

しゃべってコンシェル (Shabette concier) : Talk to the concierge and it understands what you say and allows you to easily check weather information or train transfer information, make calls, set alarm, etc. You can also enjoy chatting with various characters.

Schedule : An application for creating/managing schedules whose data is shared with Memo application. It supports i-concier service. →P115

 **Settings** : Make the terminal settings. →P122

 **Downloads** : An application for managing image data, etc. downloaded from websites.

 **Data Copy** : An application that allows you to transfer data when changing the model, back up to/restore from a "microSD card" or the "Data Storage BOX (Cloud)". →P119

 **データ保管BOX (Data Storage BOX)** : An application for using data saving box. Data Storage BOX is a service which allows you to upload files to easily manage them in the cloud.

 **Calculator** : Perform calculations such as addition, subtraction, multiplication, and division. →P118

 **Phone** : An application for using phone or making phone settings. →P67

 **Clock** : You can use the alarm, clock, timer, stopwatch and world clock. →P116

 **docomo phonebook** : A phonebook application supplied by DOCOMO. The phonebook data of docomo account can be managed in the cloud. →P76

 **docomo mail** : An application for using DOCOMO mail address (@docomo.ne.jp) to send/receive mails. Additionally, with d ACCOUNT, you can send, receive and read mail on multiple devices such as a tablet and PC browser using the same mail address. →P80

 **Drive** : Upload photos or videos saved in the terminal to the Google Drive™ so that they can be accessed from two or more devices. Documents can be created to share or to edit.

 **Instruction Manual** : Instruction Manual for this terminal (in Japanese only). You can start function directly from the description.

 **トルカ (ToruCa)** : An application for collecting saving coupons/convenient information from your favorite shops. →P97

 **Hanashite Hon'yaku** : An application that translates the speaker's language into the partner's language. You can enjoy communication with people in different languages.

 **Photos** : View or edit photos. Photos can be saved to Google cloud.

 **フォトコレクション (Photo collection)** : A service for backing up photos or videos up to 5 GB to cloud free of charge, then accessing the backup data from smartphones, tablets or PC etc.

 **Browser** : View web pages like a PC. →P87

 **Maps** : View your current location, find other locations and calculate routes. →P115

 **マネレコ (MANERIKO)** : A banking app that allows you to check the balance of your bank account, details of your credit card, etc.

 **Messaging** : Send/Receive SMS. →P80

 **Media Player** : Play music and videos. →P111

 **Memo** : An application for creating/managing memos whose data is shared with Memo application. It supports i-concier service.

 **1Seg** : Watch 1Seg. →P97

 **My Magazine** : Shown when the home application is set to "NX!Home" or "NX!Home Simple". A search service for displaying articles for categories you selected. →P65

✓INFORMATION

- The pre-installed applications are displayed in the Home screen or application list by default.
- Some pre-installed applications require separate subscriptions (charged) to be used.
- Some pre-installed applications can be uninstalled. Even if you uninstall pre-installed applications, you can download some of them again from Play Store etc. →P92
- For some pre-installed applications, installation may be required by accessing Play Store or DOCOMO's site for the first activation.

◆ Managing the application list

1 When the application list is displayed, perform target operations

Disabling applications : Touch and hold an application and drag it to [Disable app]→[DISABLE]→[DISABLE]

Uninstalling applications : Touch and hold an application and drag it to [Uninstall]→[OK]

Sorting applications : Touch and hold an application and drag it to a destination

◆ Installing a recommended application

Tap [Recommends] button to display applications recommended by NTT DOCOMO.

1 From the Home screen, →[Recommends]

- When using for the first time, an explanation screen for recommended application appears. Confirm the content and then tap [ENABLE]. The recommends applications are displayed and the notification setting turns to ON.

2 Select an application→Follow the onscreen instructions to download

✓INFORMATION

- Tap  on the recommended application list to switch ON/OFF the notifications of recommended applications in [Notification settings].

◆ Display all apps

It is a function to search applications.

1 From the Home screen, →[Display all apps]



A list of all applications is displayed. Tap an application in the page to activate the application. Tap  to jump to the screen where the application is displayed with the icon focused.

Backup and restoration of Home screen

You can restore the Home screen layout such as applications and widgets using docomo LIVE UX data backed up in docomo cloud. If you use it, docomo service page will be added to the home screens at the end.



- To backup/restore the Home screen layout, you need to set d ACCOUNT.

◆ Backing up the Home screen layout

1 From the Home screen,  →  → [Layout backup & Restore]

2  → [BACKUP]

◆ Restoring the Home screen layout

1 From the Home screen,  →  → [Layout backup & Restore]

2 [Restore the latest backup data] → [Restore]
Restoring data from the list : [Restore from backup data list] → Select data → [Restore] → [Restore]

✓ INFORMATION

- Some icons or widgets may not be restored. docomo service page may not be added at the last of home screens.

My Magazine

My Magazine is a search service for displaying articles for categories you selected. It helps to set search words based on your tendency of articles to read or profile information to bring them closer to your preference. You can also configure My Magazine so that it can be customized using notifications, location information, docomo service contract information, etc.

◆ Viewing articles

1 From the Home screen, 

The list screen divided by genres appears.

- When you set for the first time, the explanation screen for My Magazine appears and you can select categories. Confirm the content and tap [OK].
- Alternatively, flick upward on the Home screen to display My Magazine.
- When the confirmation screen of Twitter link or use of information is displayed, follow the onscreen instructions.
- Flick left or right to switch genres.
- Tap [See more info] to display the information list screen in which you can view other articles than displayed in the article list screen.

2 Tap the article you want to read

◆ Category setting

You can select categories for information you want to view in My Magazine.

1 From the Home screen,

The list screen divided by categories appears.

2 → [Display category setting] → Select categories

✓ INFORMATION

- On the list screen, tap  to change My Magazine settings or check the Help.

Information of Home app

You can check the provider of docomo LIVE UX, version information, etc.

1 From the Home screen, → → [About]

- If the update of docomo LIVE UX is available, [Update now] is displayed in the application information screen. Tap it to update docomo LIVE UX.

Calling

Making a call/video call

1 From the Home screen, 

2 [Dial]→Enter a phone number

- To correct phone number, tap 

Notifying caller ID :  →[Caller ID notification]→[Notify]/[Not notify]

- Your caller ID is important personal information. So, take care when notifying people of it.

Selecting prefix :  →[Select prefix]→Select a prefix

- Select a number registered in "Prefix settings" (prefix) (→P74) beforehand to add before a phone number.

Adding 2-sec pause/wait :  →[Add 2-sec pause]/[Add wait]→Enter an additional number

- Used to enter main phone number and additional code at once when entering the code additionally during a call for bank balance inquiries, ticket reservation services, etc.

2-sec pause "," : When the phone number is dialed, 2-second pause will be automatically inserted and then additional code will be sent.

Wait ";" : When the phone number is dialed, the phone will wait automatically and a confirmation message for sending additional code appears. When you tap [YES], the additional code is sent.

3 

Making a video call :  →[Video call]

4 When a call is ended, [END CALL]

✓INFORMATION -----

- With VoLTE, you can make high-quality voice and video calls. To use VoLTE, both parties must meet the following requirements.
 - Both terminals support VoLTE
 - Both parties are in a VoLTE service area
 - "Network Mode" in "Cellular networks" (→P174) is set to [4G/3G/GSM(Auto)], and "Call mode setting" is set to ON
- On a video call, both speakers can see each other while talking. You can also switch between voice and video calls.
 - When you make a video call, voice call and packet communication charges will apply. When you receive a video call, packet communication charges will apply.
 - Video call imaging is based on best-effort communication (which optimizes transmission speed depending on how busy your network is), so the quality of video images varies depending on your network environment.
 - If your terminal failed to switch to a video call during a voice call, a message appears on the screen indicating that the failure occurred, and the voice call is maintained.
 - Since imaging for video call varies by terminal model, your terminal and the other party's terminal may show different image in scope.
- If your face etc. comes close to the proximity sensor during a call, the display goes out. It is redisplayed by moving away from the sensor.

- When the earphone is inserted into the terminal or while calling with the speakerphone, the proximity sensor stops and the display remains on even when the face, etc. comes close to the sensor.
- If you put the ear to the earpiece/speaker over the hair, etc. the proximity sensor does not work normally and the call may be interrupted.
- You can set to show/hide caller ID all at once in "Caller ID notification" (→P73).
- For details on sending touch-tone signals during a call, see "Operation during a call". →P70

◆ Emergency call

Emergency call	Phone number
Police call	110
Fire and emergency rescue	119
Coast guard	118

- This terminal supports "Emergency call location notification". If you use the terminal to place a call to emergency numbers such as 110, 119, or 118, the information of a location where you are calling from (location information) is automatically notified to the Emergency call acceptance organization such as the Police Station. The Emergency call acceptance organization may not be able to figure out your exact location depending on the location where you place a call or radio wave condition. When location information is notified, name of Emergency call acceptance organization you are calling to will appear. If you dial by adding "184" in front of your number to hide your caller ID, your location information and phone number are not notified. However, if the agency you called considers your location information and phone number necessary for important purposes such as life saving, the agency can retrieve your accurate location information obtained via GPS and phone number regardless of your mobile settings. Note that the areas/time for which the "Emergency call location information" is ready to be used vary depending on the preparatory state of each Emergency call acceptance organization.
- When you call the Police (110), Fire/Ambulance (119), or Maritime rescue (118) from the terminal, clearly indicate that you are calling from a mobile phone, then give your present location and mobile phone number. Also, make a point to call in a stationary position to prevent the call from being dropped. Do not power off the terminal for at least 10 minutes after the emergency call just in case the Police or Fire/Ambulance may have to get in contact with you.
- Note that you may not connect to the local Fire Department or Police Station depending on where you are calling from.

- In Japan, if the docomo nano UIM card is not inserted, emergency calls 110, 119 and 118 cannot be made on the PIN code entry screen, during PIN code lock/PUK lock or while updating software.
- If you dial 110, 119, or 118 overseas, an emergency call screen may appear but the call is normally sent.
- If you make an emergency call with Reject call settings enabled, Reject call settings will be disabled.
- Emergency call may not be available via some networks.
- You cannot make emergency call with video call.

◆ International call (WORLD CALL)

Enter "+" to make an international call. Touch and hold [0] to enter "+".

- To use overseas, refer to "Outline of international roaming (WORLD WING)". →P172
- For details of "WORLD CALL", contact "General Inquiries" on the last page of this manual.

1 From the Home screen, → [Dial] → Touch and hold [0] → Enter "Country code-Area code (City code) omitted prefix 0 and phone number →

- If [Automatic conversion] for [International dial assist] is marked, "International dial assist" screen appears when sending. Tap [Convert number] or [Use original number].
- In some countries and areas such as Italy, "0" is required.
- When selecting from the country list to enter "+ country code", enter the area code (city code) and phone number, → [International call] → Select a country → [WORLD CALL].

Receiving a call/video call

◆ Receiving a voice call

<Example> When a call is received in sleep mode

1 A call is received

The incoming call screen (full-screen) appears.

- Press /volume key to stop ringtone or vibration.
- When receiving a call with VoLTE, "HD" is displayed at the top of the screen. However, depending on connected network, it may not be displayed.

2 → [ACCEPT]

Declining call : → [REJECT]

Rejecting a call and sending SMS : → [Reject call with SMS] → Select a message

Recording phone memo : → [Phone memo]

3 When a call is ended, [END CALL]

◆ Receiving a video call

<Example> When a call is received in sleep mode

1 A call is received

The incoming call screen (full-screen) appears.

- Press /volume key to stop ringtone or vibration.
- When receiving a call, "HD" is displayed at the top of the screen.

2 →[ACCEPT VIDEO]

Accepting with voice call : →[Accept voice]

Rejecting a call : →[REJECT]

Rejecting a call and sending SMS : →[Reject call with SMS]→Select a message

Accepting with camera OFF : →[Camera OFF response]

Recording phone memo : →[Phone memo]

3 When a call is ended, [END CALL]

✓INFORMATION

- When receiving a call while the Home screen is displayed or application is activated, the incoming call screen is displayed at the top of the screen. After you accept and end call, the previous screen is displayed. Tap a caller's name or phone number on the incoming call screen, the incoming call screen (full-screen).
- When you could not answer a call, notification icon (→P50) appears on the status bar. Open the Notification panel (→P52) to check missed calls, dial or send SMS.
- Incoming calls are answered when the terminal is simply held up to the ear.
To use this function, set "Suguden setting" (→P74) to ON.

Operation during a call

The following operations are possible in the screen during a call.

- You can adjust call volume with the volume key while dialing/during a call.

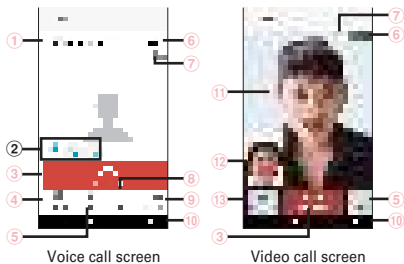

① Name or phone number

② Status of Voice clear/Voice adjusting/Voice slowing

Since Voice adjusting also activates while using Voice clear, the sound quality will be adjusted to more suitable than Voice clear. It recognizes caller's action or the ambient condition and "Walking", "Run", "Quiet", "Crowds" or "Noisy" is displayed.

③ End call

④ Show/hide the dialpad for dial input

Send touch-tone signals (DTMF tones).

- To input dialing number during a video call, tap →[Dialpad].

⑤ **Set MUTE to ON/OFF**

When it is set to ON, your voice cannot be heard by the other party.

⑥ **Call time**

⑦ **Calling (high-quality sound)**

- Appears during a call with high quality sound.

⑧ **Set speaker phone to ON/OFF**

- When connecting a Bluetooth device, tap to switch voice output devices.

⑨ **Switch to video**

Tap to display a selection screen for switching to video call on the other party's terminal. If it is accepted, switching to video call is available.

- To switch to voice call during a video call, tap  → [Switch to voice call].

⑩ **Display submenu**

During a voice call : Operate ON/OFF of Voice clear, ON/OFF of Voice slowing, Hold*/Cancel hold, add a call with the another party using the call waiting.

During a video call: Switching operations of audio, dial keys, speech output, camera OFF/ON, image area of yours and third party's are available.

- * To use Hold function, Call waiting subscription is required.

⑪ **Image of the other party**



- If receiving the other party's image is not available or the camera function turns off because the screen changes to another screen,  is displayed.
- Tap the screen to switch the other party's image between in full-screen and normal screen.

⑫ **Your image**

⑬ **Switch camera for sending image**

Switch camera (in-camera/out-camera) to shoot image for sending.

✓INFORMATION -----

- Enable Voice clear to improve call sound to be heard clearly by emphasizing the other party's voice or adjusting the listening sound.
- Setting Voice slowing to ON adjusts the other party' voice speed so that his/her voice can be heard slowly and easily. If the other party speaks without pause, the voice is heard with normal speed.
- For subscribers of Call waiting, during a voice call, tap  → [Add call] to make a second call.
- When speaker phone is ON, you can talk handsfree using the speaker.
- During a video call, to switch voice output when connecting a Bluetooth device,  → [Switch audio output destination] → Select the voice output device.
- During a video call, when a calling screen is not displayed because you change to another screen, your image will not be sent to the other party.
- While in multi-connection such as using call waiting, status of Voice clear/Voice adjusting/Voice slowing does not appear.
- Voice clear, Voice adjusting and Voice slowing do not support video calls.

Recent calls

You can check call history.

1 From the Home screen, 

2 [Recent calls]

Recent calls screen is displayed.

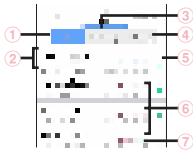

1 All tab

Display all incoming and outgoing calls.

2 Name or phone number

Tap to make a voice call, send SMS, make a video call, add to phonebook, display the profile screen, etc.
Touch and hold to edit phone number and call or to delete from the history.

3 Incoming tab

Display received call history only.

4 Outgoing tab

Display dialed call history only.

5 Voice call button

Make a voice call.

6 History

Display "Outgoing call"/"Incoming call"/"Missed call".
• In Recent calls, call type such as voice call or video call is not displayed.

7 Date and time for incoming/outgoing call

◆ INFORMATION

• Up to 500 items can be displayed in Recent calls.

◆ Deleting call history

1 On the history screen, tap  → [Delete log]

2 Mark items you want to delete → [Delete] → [Delete]

• Tap [Select all] to delete all items.

Phone memo

Set phone memo or play/delete recorded phone memos.

- Note that accepting a video call by phone memo automatically changes it to a voice call and the image is not recorded.

1 From the Home screen,  →  → [Call settings] → [Phone memo]

2 Set required items

Enable phone memo : Set ON/OFF of Phone memo.

- If number of saved phone memos exceeds the saving limit, the terminal does not answer calls with Phone memo even when the setting is enabled.

Phone memos : Display a list of recorded phone memos.

Select a phone memo → Tap  to play the message.

- To delete a message, touch and hold a phone memo → [1 memo delete] → [YES]. When a message notifying that there is no phone memo is displayed, tap [OK].
- To delete all the messages, tap  → [Delete all] → [YES] → [OK].
- Up to 60 seconds per message and up to 10 messages can be recorded for Phone memo.

Phone memo settings : Set answer time or reply message.

Call settings

Make various settings for DOCOMO network services, call and Internet call.

1 From the Home screen,  →  → [Call settings]

2 Set each item

Network service : The following DOCOMO network services are available.

Voice mail service^{*1} : Start/stop the service, or set call time, etc.

Call forwarding service^{*1} : Start/stop the service, change forwarding number, etc.

Call waiting^{*1} : Start/stop the service, or check the settings.

Caller ID notification : Set notification or confirm settings.

Nuisance call blocking service : Register, remove, check registered numbers or the Advanced settings.

Caller ID display request service : Start/stop service, or check the settings.

Call notification : Start/stop the service, or check the settings.

English guidance : Set or check the settings.

Remote operation settings : Start/stop the service, or check the settings.

Public mode (power OFF) settings : Start/stop the service, or check the settings.

Roaming settings : Setting steps → P176

Phone ringtone : Set phone ringtone.

Vibrate on ring : Set whether to vibrate while ringtone is sounding.

- You cannot set during manner mode.

Dialpad touch tones : Set whether to sound when operating the dial pad.

Phone memo : Setting steps→P73

Reject call setting : Make settings for rejecting calls.

- Tap the following item to set the call rejection.

Reject unregistered call : Set whether to reject incoming calls unregistered in the phonebook.

Reject anonymous call : Set whether to reject anonymous call.

Reject call from pay phone : Set whether to reject call from pay phone.

Reject unknown call : Set whether to reject call unknown call.

Specified number rejection : Set to not receive calls and SMS messages from the specified parties.

Rejection SMS : Edit rejection SMS messages for incoming call.

Sub address settings : Set whether "*" in phone number is identified as a sub address separator.

Prefix settings : Set a number added before phone number when making a call.

Reverb suppression^{*2} : Set whether to suppress reverberant sound during a call in a place where voice sound echoes to make your voice clear to be heard.

Suguden setting^{*1} : Set "Suguden" to answer just via motion.

Answer : Set whether to answer by placing the terminal to your ear.

Disconnect : Set whether to disconnect the call by putting the terminal horizontally with the screen facing down or by shaking the terminal twice during a call.

Call^{*3} : Set whether to make a call to the registered number or the number in Recent calls by shaking the terminal once with the Home screen displayed and then placing the terminal to your ear.

Mute, Reject : Set whether to reject a call by placing the terminal horizontally with the screen facing down or by shaking the terminal twice while incoming a call. Select from "Mute", "Reject", or "Reject and send SMS".

Call ranking : Check the parties whom you made a lot of calls.

Hide the name when receiving^{*4} : Set whether to hide the names registered to the phonebook until handling the terminal when receiving their calls.

Sending of use information : Allow to send use information for improving the Suguden function or enhancing the convenience. You can use the Suguden function even if it is set to OFF.

Disable Suguden during roaming^{*5} : Set whether to turn off the Suguden during the international roaming.

Contact docomo : Make a call to each inquiry office ; "ドコモ故障問合せ (DOCOMO repair office)", "ドコモ総合案内・受付 (DOCOMO General Inquiries)", "海外紛失・盗難等 (For lost, theft, etc. while overseas)", "海外故障 (For malfunction while overseas)".

Calling accounts : Set for Internet calling (SIP) account or using SIP call.





Open source licenses : Confirm open source licenses.

Extension line service setting^{*6} : Make setting to use the Office Link holding and forwarding line service.

*1 Not supported to video calls.

- *2 Not supported to VoLTE.
- *3 Making a call operation is available while the Home screen or the lock screen is displayed.
- *4 The setting is available only on the incoming call screen (full-screen) of the call or video call. The name may not be hidden on other screens.
- *5 Suguden function is disabled overseas automatically. To use the function overseas, set Disable Suguden during roaming to OFF in the Suguden setting.
- *6 The Office Link is an extension line service for corporate customer.

✓ INFORMATION

- Alternatively, you can set call settings from the Home screen, tap  → [Settings] → [Useful tools] → [Voice call] → [Call settings].
- From the Home screen, tap  → [Settings] → [Useful tools] → [Voice call] → [Voice adjust] to adjust listening volume for making it easy to understand.
- From the Home screen,  → [Settings] → [Useful tools] → [Voice call] → Mark [Power button ends call] to enable ending a call by pressing . Note that you cannot end call by pressing  in sleep mode.
- Suguden cannot be used in the following cases.
 - When using speakerphone
 - When using earphones or headphones or using a Bluetooth device that supports calling
 - While making a call or switching calls when already taking a call
 - While lying down
 - While running or going up and down stairs

- When covering up the display with a book-type smartphone case etc.
- If [Suguden setting] is ON, and the terminal is placed within a bag or pocket while on the incoming call screen, movement that registers as an operating motion may cause the call to be answered or disconnected.
- The proximity sensor does not respond well to black objects. (When answering a call) If hair is blocking the earpiece as you bring the phone to your ear, the proximity sensor may have trouble working and cause the call to not pick up. In this case, place the earpiece directly against your ear. (When disconnecting/rejecting a call) Turning the terminal over on a black desk, etc. may cause the operation to fail (cannot disconnect/reject). In this case, instead of placing the terminal directly on the surface, raise the terminal 1 cm from the desk, etc. as you flip it over to operate (disconnect/reject).
- The Suguden (answer) function uses the proximity sensor as one of the motion determinations. If you use the function with the proximity sensor (→P29) soiled, you cannot answer properly, and loud sound may emit near your ear, resulting in a hearing loss. Clean the sensor regularly.
- If a motion is performed when [Disconnect] for the Suguden setting is set to ON, disconnection is activated in the following cases, and the call is disconnected.
 - While the other party is holding
 - While Phone memo is active (playing back a greeting/recording a message)
- The "Hide the name when receiving" function displays the caller's name when receiving a call and Phone memo is active.

- Shaking the terminal strongly is recognized as an operating motion and may cause the call to be muted, rejected, or disconnected.
- If the disconnection motion of facing down of the terminal's screen is too fast, the operation may fail (cannot disconnect). In this case, perform the motion slowly so that the terminal can respond (disconnect).
- The terminal emits the ringtone from the earpiece. When you use the Suguden (answer) function, the terminal detects that it is near your ear and sets the proper sound volume, but if the terminal does not detect it, loud sound may emit near your ear. Set the ring volume to a properly. Too loud volume may cause a hearing loss. You can set the ring volume from the Home screen, **[Home]**→[Settings]→[Display/Sound/Apps]→[Sound]→[Ring volume].

Phonebook

You can register phone numbers, email addresses, etc. to the phonebook. You can contact registered parties through simple operation.

- To use cloud on the phonebook, docomo phonebook application is needed. For the first time activation of docomo phonebook application (including after the application is initialized), "Use of Cloud" screen appears and you can start use of cloud.
- When using functions that can be used by users or guests, guests can use no functions related to the cloud service of docomo phonebook.

1 From the Home screen, [ドコモクラウド (docomo cloud)]→[docomo phonebook]

2 [Contacts]

Phonebook list appears.

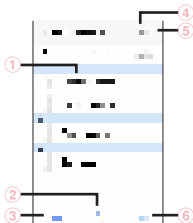

- ① **Name**
Tap to display the profile screen. In the profile screen, you can make a call, send SMS, etc.
- ② **Search**
Search contacts.
- ③ **Register→P77**
Register a new phonebook entry.
- ④ **Logging in to/out from cloud**
- ⑤ **Display submenu**
You can delete contacts, operate the cloud menu, SD card/SIM card/sharing, settings, or view help, number of registrations, application information.
- ⑥ **Index**
Display the index. Search entries in the order of Japanese syllabary, alphabet, etc.

◆ Adding an entry to the phonebook

1 In the phonebook list, [Register]→Set each item→[Save]

- Contacts data registered in docomo account can be synchronized with Cloud.
- When Google account is registered, tap [Set] in the account field to select the Google account.

✓INFORMATION -----

- You can also add phonebook entry from the call history.

◆ Editing a phonebook entry

1 In the phonebook list, select a contact→[Edit]→Edit each item→[Save]

◆ Deleting a phonebook entry

1 In the phonebook list, select a contact to delete → ⋮ →[Delete]→[OK]

- In the phonebook list, ⋮ →Tap [Delete contact] to select and delete contacts. Mark [Select all]→[OK]→[OK] to delete all contacts.

◆ Using Group

1 In the phonebook list, [Group]

2 [Add group]→Set each item→[OK]

Sorting groups : [Sort]→In the group list, tap a group and slide upward or downward→[OK]

Editing a group : In Group list, tap a group→[Edit]→Set each item→[OK]

- Alternatively, touch and hold a group in Group list→[Edit group].

Deleting group : In the group list, touch and hold a group →[Delete group]→[OK]

- In Group list, tap ⋮ →[Delete group] to select a group to delete.

✓INFORMATION -----

- Only groups of docomo account can be sorted.

❖ Registering a contact to a group

- 1 In the phonebook list, [Group]
- 2 Select a group → [Add member] → Mark a contact to add → [OK] → [OK]

Canceling group : Select a group → [Delete member] → Mark a contact to delete → [OK] → [OK]

◆ Displaying profile screen

- 1 Select a name in the phonebook list

Profile screen appears.



- ① **Account icon**
- ② **Image and name set in the phonebook entry**
- ③ **Registration information**
Tap an item to send a call or email etc. Touch and hold to display the options.
- ④ **Favorites**
Added to "Favorites".
- ⑤ **Voice call button**
Make a voice call.

✓INFORMATION -----

- Tap on the profile screen to operate sharing, etc.
- To display phonebook entries added to "Favorites", in the phonebook list, tap [Group] → [Favorites].

◆ Importing/Exporting phonebook entries

- 1 On the phonebook list, → [SD card/SIM card/common] → Select an item

Restore from SIM card : Type of phone numbers and mail addresses are imported as "Others".

Activate docomo Data Copy app : Activate docomo Data Copy application and back up or restore the phonebook entries or other data to or from a microSD card collectively. → P119

Send all data (common) : Create export data of the phonebook entries (.vcf). Open the Notification panel and then tap the notification of "Finished exporting contacts. Tap to share contacts". Select the application such as Bluetooth or the mail application to perform sending operation.

* It is not supported for some applications.

✓INFORMATION -----

- If you try to send all phonebook entries via Bluetooth communication to an i-mode terminal, data cannot be moved normally.

◆ My profile

You can check your own phone number. You can also register or edit your own information.

1 From the Home screen, [ドコモクラウド (docomo cloud)]→[docomo phonebook]

2 [My profile]

3 [Edit]→Set required items→[Save]

- To perform Send My profile, tap  →[Send My profile] and follow the on-screen instructions.

docomo mail

Send/receive mails using DOCOMO mail address (@docomo.ne.jp).

Since sent/received mails are stored to docomo mail server, your mails can be transferred easily in case the terminal is lost or you change the model. Additionally, with d ACCOUNT, you can send, receive and read mail on multiple devices such as a tablet and PC browser using the same mail address.

For details on docomo mail, refer to NTT DOCOMO website. https://www.nttdocomo.co.jp/service/docomo_mail/ (In Japanese only)

1 From the Home screen, .

From here on, follow the onscreen instructions.

Messaging (SMS)

You can send and receive text messages with a mobile phone number as the destination.

* For details on a number of characters that you can send/receive etc, refer to "Short Message Service (SMS)" on the NTT DOCOMO website.

◆ Creating and sending SMS

1 From the Home screen,  → [Messaging]

2 [NEW MESSAGE] → Enter a mobile phone number → [確定 (Done)]

- When a phone number or reading is entered, the contacts matching the phonebook data appear and then you can select from them.

3 [Type message] → Enter a message → [Send]

✓INFORMATION -----

- SMS can be also sent to or received from the parties using overseas network operators. For countries and overseas network operators available, refer to NTT DOCOMO website.
- To send to users of overseas network operators, enter "+", "Country code" and then "the recipient mobile phone number". Alternatively, enter "010", "Country code" and "the recipient mobile phone number" to send messages. Enter a phone number without a leading "0", if any.

◆ When SMS is received

When an SMS message is received, the notification icon appears on the status bar (→P50). To check the new SMS, open the Notification panel (→P52) and then tap the notification.

✓INFORMATION

- If the terminal is initialized and an SMS is received right after rebooting, ringtone and vibrator may not work regardless of notification settings for SMS.
- SMS cannot be received when the terminal is low on memory. Delete unnecessary applications etc. to obtain memory space.→P93 , P138

◆ Displaying sent/received SMS

1 From the Home screen, →[Messaging]

2 Select a message thread

- Tap [CALL] to make a call.

◆ Replying to SMS

1 From the Home screen, →[Messaging]

2 Select a message thread→[Type message]→
Enter a message→[Send]

◆ Forwarding SMS

1 From the Home screen, →[Messaging]

2 Select a message thread→Touch and hold SMS
→[Forward]

3 Enter a mobile phone number→[確定 (Done)]→
[Send]

- When a phone number or reading is entered, the contacts matching the phonebook data appear and then you can select from them.

◆ Deleting SMS

1 From the Home screen, →[Messaging]

2 Select a message thread→Touch and hold SMS
→[Delete]→[DELETE]

✓INFORMATION

- To delete a message thread, touch and hold a message thread→Tap [DELETE]→[DELETE].
- To delete all message threads, in the message thread screen, tap [MENU]→[Delete all threads]→[DELETE].

◆ Setting SMS

1 From the Home screen,  → [Messaging] → [MENU] → [Settings]

2 Set each item

SMS Enabled : Set the default SMS application.

Delete old messages : Set whether to delete old messages if the number of saved messages reaches upper limit.

Text message limit : Set the number of messages to save per thread.

Backup : Copy messages between the terminal and a microSD card.

Delivery reports : Set whether to require acknowledgement of receipt for a message to send each time.

Manage SIM card messages : Manage messages saved on the docomo nano UIM card.

Notifications : Set whether to show notification on the status bar when receiving a message.

Sound : Set ringtone when receiving a message.

Vibrate : Set whether to vibrate the terminal when receiving a message.

LED : Set color of indicator LED when receiving a message.

Set the smsc number : Set the message center number.

- Making the setting is not necessary normally.

✓INFORMATION

- On the SMS setting screen, tap [MENU] → [Restore default settings] for restoring the default settings.

Gmail

You can use email provided by Google or other general providers.

- If Google account or email account is not set, follow the onscreen instructions.

◆ Displaying Gmail

1 From the Home screen, [Google] → [Gmail]

A list of message threads is displayed in the inbox.

- For details on Gmail, tap  or flick right the left end of the screen → Tap [Help & feedback] to see Help.

NX! Mail

Set docomo mail address (@docomo.ne.jp) or an email account provided by general provider to use Email.
To use NX! Mail, download the application from Google Play.

1 From the Home screen,  → [NX! Mail]

2 Follow the onscreen instructions

◆ Setting up Email account

- Obtain the information required for setting up the mail account from your service provider in advance.

1 From the Home screen,  → [NX! Mail]

2 [DOCOMO MAIL] / [GOOGLE ACCOUNT] / [ANOTHER ACCOUNT] / [EXCHANGE ACCOUNT]

From here on, follow the on-screen instructions and enter mail addresses and passwords etc. to configure the mail account.

✓INFORMATION

- You can use SMS.
- If you have already set a mail account and want to add on another mail account, on the folder list, tap [MENU] → [Settings] → [Account setting] → [Add new account] to operate.
- If you have already set an Exchange account and want to add on another Exchange account, on the folder list, tap [MENU] → [Exchange Settings] → [Add account] to operate.

◆ Creating and sending an email

1 From the Home screen,  → [NX! Mail]

- The folder list screen appears.
- If a folder is set for the startup screen (→P84), the mail list screen of the set folder appears.

2 [CREATE]

- When the Exchange account and other account are set, tap [Create EXCHANGE mail] / [Create other mail]
- When multiple account is set, tap "From" → tap the mail account to use to exchange accounts.

3 Enter the mail address in the address field

- To add a destination, enter the mail address in the field displayed below the address field you previously entered in.

4 Enter a subject in the field.

5 Enter a message in the message field

6 [SEND]

✓INFORMATION

- With some service providers, settings for "OP25B (Outbound Port 25 Blocking) : spam mail transmission blocking" are needed. For details, contact the service provider you are subscribed to.
- Email is handled as email from a PC. If the receiver sets rejection of emails from PCs, the email cannot be sent.

◆ Receiving/Displaying emails

- 1 From the Home screen, **□**→[NX! Mail]
- 2 [MENU]→[Update]
- 3 In the folder list screen, select a folder→In the email list, select an email

◆ Replying to an email

- 1 Display an email
- 2 [REPLY]
Replying all : [REPLY ALL]
- 3 Enter a message→[SEND]

◆ Forwarding an email

- 1 Display an email
- 2 [MENU]→[Forward]
- 3 Enter a mail address/message→[SEND]

◆ Deleting emails

- 1 From the Home screen, **□**→[NX! Mail]
- 2 In the folder list screen, select a folder→In the email list, touch and hold an email to delete→[Delete]→[OK]

◆ Operations on the folder list screen

- 1 Display the folder list screen
 - Displaying the mail list screen in a folder :** Tap the folder to display the mail list screen of
 - Creating a new folder :** [Create folder]→[Create folder from phonebook group]/[Create folder by yourself]→Set items→[FINISHED]
 - Sorting folders :** Touch and hold the folder to sort→Drag the folder to the desired position
 - Setting a folder as the startup screen :** Touch and hold the folder to set as the startup screen→[Set as start screen]
 - When you launch NX! Mail, the mail list in the specified folder is displayed.
 - To cancel the startup screen, touch and hold the folder to cancel→Tap [Cancel start screen].
 - Editing a created folder :** Touch and hold the folder to edit→[Edit]→Set items for the folder→[FINISHED]
 - Deleting a created folder :** Touch and hold the folder to delete→[Delete]→[OK]
 - Displaying the menu :** [MENU]
You can perform operations such as refreshing emails, editing the account, backing up/restoring emails, and the mail setting.

◆ Setting Email

Make Email settings.

❖ General settings of NX! Mail

1 On the folder list screen, [MENU]→[Settings]

2 Set required items

Incoming settings : Set the operation when receiving an mail.

Account settings : Add the account and settings.→P85

Change layout : Set the layout of the folder list screen.

Mark : Set the mark available for received mails.

• Up to 3 marks can be set.

Display folder : Set whether to display the folders of protect/unclassified/SMS.

Signature : Set the signature.

SMS : Set the SMS application used as default and set the operation when receiving SMS.

Other : Perform other settings related to NX! Mail such as quoting for reply, displaying the reply source mail/SMS on the reply screen, displaying the mail sending screen, changing the backup destination for emails.

✓INFORMATION

- Tap [Information] to check the NX! Mail version, saved numbers of mails, and used license.

❖ Account settings of NX! Mail

- Available items vary depending on account type.

<Example> Setting IMAP account

1 On the folder list screen, [MENU]→[Settings]→[Account settings]

The account list screen is displayed.

2 Select an IMAP account→Set each item

Account name display : Edit an account name.

Change icon : Change the icons displayed next to the account names.

Name displayed in outgoing email : Edit the displayed name to be displayed to the receiver of emails.

Default send address : Use the marked account as default when making a new email.

Receive interval : Set the receiving interval of emails.

Edit email address : This cannot be changed normally.

Incoming server settings : Set the received mail server.

Outgoing server settings : Set the sending mail server.

Show "All received" folders : Set whether to display mails in the selected folder in "All received".

Reply address : If you want to receive a reply with a mail address different from the one you sent, enter the address for reply.

Ringtone : Set the ringtone for incoming mail.

Vibration : Set whether to vibrate the terminal when an email is received.

LED : Set the color of the Indicator LED for incoming mail.

Character code when sending mail : Set the character codes for emails.

✓INFORMATION

- Setting the push receiving to Receive interval accelerates the battery consumption.
- To delete an email account, touch and hold the account to delete on the account list screen→Tap [Delete]→[OK].

❖ Backing up/Restoring emails

■ Backing up

1 On the folder list screen, [MENU]→[Backup/Restore emails]

- If the confirmation screen notifying that Exchange is not supported, tap [OK].

2 [Backup emails]→[vmg] / [eml]

3 Place a check mark on the items to back up→[OK]→[OK]

■ Restoring

1 On the folder list screen, [MENU]→[Backup/Restore emails]

- If the confirmation screen notifying that Exchange is not supported, tap [OK].

2 [Restore emails]→Select an account

3 Select the restore destination→Place a check mark on the data to restore→[OK]→[OK]

✓INFORMATION

- The backup destination can be changed.→P85

Early warning "Area Mail"

Area Mail is a service which allows you to receive earthquake early warning or tsunami warning, emergency warning related to weather etc. delivered by the Meteorological Agency, and disaster/evacuation information delivered by the national government or local governments without being influenced by congestion.

- Area Mail is a free service and subscription is not required.
- Up to 50 items can be saved.
- Area Mail cannot be received during a voice call (except for voice call using VoLTE), when the power off, in Airplane mode, while updating software (except for while downloading), during international roaming, while the PIN entry screen is displayed, etc. When the terminal is low on available memory, reception may fail.
- You cannot receive the unreceived Area Mail (Earthquake Early Warning). Area Mail (Tsunami warning, emergency warning related to weather etc., Disaster/Evacuation information) can be resent, so you can receive the unreceived ones.

◆ When receiving Early warning "Area Mail"

When Area Mail is received, the buzzer beeps or the Area Mail ringtone sounds, the notification icon (→P50) appears on the status bar, and the detailed screen is displayed.

- The buzzer alarm or the incoming ringtone sounds in maximum volume by default. The alarm volume can be changed.→P87

- By default, the sound is emitted even in Manner mode. You can set to disable the sound. →P87

◆ Displaying received Area Mail

1 From the Home screen,  → [Disaster kit] → [Early Warning "Area Mail"]

2 Select an Area Mail

◆ Deleting Area Mail

1 From the Home screen,  → [Disaster kit] → [Early Warning "Area Mail"]

2 Mark Area Mail to be deleted → [Delete] → [OK]
• To select all, tap [Select all].

◆ Setting Early warning "Area Mail"

1 From the Home screen,  → [Disaster kit] → [Early Warning "Area Mail"]

2  → [Settings]

3 Set each item

Receive setting : Set whether to receive Area Mail.

Beep tone : Set sounding time and volume of beep tone, or set whether to sound beep tone in Manner mode.

Check screen image and beep tone : Check the reception screen and beep tone for Area Mail such as Earthquake Early Warning, Tsunami Warning, Disaster/Evacuation information (including emergency warning related to weather etc.).

やさしい日本語表示 (Simple Japanese display) : Set whether to display Earthquake Early Warning and Tsunami Warning in simple Japanese.

翻訳・アプリ連携設定 (Translation/App link setting)* : Set to translate the received contents or set whether to use link with other application.

* This item is not displayed when the terminal language is set to English.

Browser

You can view web pages like on a PC using Browser. On the terminal, Browser can be used over a packet communication or Wi-Fi connection.

◆ Operation while viewing website

■ **Switching web page in portrait/landscape view**

Tilt the terminal vertically or horizontally to switch the portrait/landscape view.

■ **Scroll/Pan**

Scroll the screen up/down or left/right or pan (→P38) in all directions to display the desired part of the screen.

■ Zooming in/out on web page

Pinch-out/Pinch-in : Zoom in/out.

Double-tap : Zoom in.

- To return to the view before it is zoomed in, double-tap again.

◆ Activating Browser to display a website

1 From the Home screen,

The preset home page is displayed.

- Slide the screen downward to display the address bar at the top part of web page. Enter URL or a keyword in the address bar.

◆ Opening a new browser window

You can open 2 or more browser windows and switch web pages quickly.

1 When a web page is displayed, slide the screen down to display the top of the screen → [Tab]

2 [New Tab]

A new browser window opens and the preset home page is displayed.

Switching : Select browser window

Closing : [X] on the browser window

◆ Displaying website in incognito tab

You can browse web pages without leaving browsing/searching history.

1 When a web page is displayed, slide the screen down to display the top of the screen → [Tab]

2 [Menu] → [New incognito tab]

A web page is displayed in incognito tab.

- Enter URL or a keyword in the address bar.
-  appears at the top of the screen while a window opens in incognito tab.
- To close incognito tab, when a web page is displayed, slide the screen down to display the top of the screen → [Tab] → Tap [X] of incognito tab.

✓ INFORMATION -----

- Web pages opened in incognito tab are not left in the history. However, downloaded files or web page added to bookmarks is saved.

◆ Displaying web page from history

1 When a web page is displayed, slide the screen down to display the top of the screen → [Menu] → [Bookmarks] → [HISTORY]

2 Select browsed timing of [Today] or [Yesterday], or [Most visited] → Select a history of web page

- To display the history of frequently viewed web pages, tap [Most visited].

◆ Adding bookmark to view website

❖ Registering a bookmark

- 1 When a web page is displayed, slide the screen down to display the top of the screen → [Menu] → [Save to bookmarks]

Details of bookmark are displayed. You can change the label name, location to be added, etc.

2 [OK]

❖ Displaying web pages from bookmarks

- 1 When a web page is displayed, slide the screen down to display the top of the screen → [Menu] → [Bookmarks]

2 Select a bookmark

Editing : Touch and hold a bookmark → [Edit bookmark] → Set required items → [OK]

Deleting : Touch and hold a bookmark → [Delete bookmark] → [OK]

◆ Saving and displaying a web page

A displayed web page is saved and displayed offline.

❖ Saving a web page

- 1 Slide the screen downward while a website is displayed to display the upper part of the web page → [Menu] → [Save for offline reading]

❖ Displaying the saved web page

- 1 Slide the screen downward while a website is displayed to display the upper part of the web page → [Menu] → [Bookmarks] → [SAVED PAGES]

2 Select the saved page

- While the saved page is displayed,  is displayed on the upper side of the screen.

Deleting : Touch and hold the saved page → [Delete saved page] → [OK]

✓ INFORMATION -----

- When the saved web page is displayed, it may be performed like the followings depending on the contents.
 - The page may not be moved by tapping the link.
 - A part of web pages such as an advertisement may not be displayed.
 - JavaScript in the web page is not performed.

◆ Web page link operations

Tap a link displayed on web page to operate the following.

- Touch and hold a link to display menu options; save the link or copy the URL.

URL : Open the web page.

Email address : Create a new mail.

Phone number : Call to the phone number.

File : View/save the file.

✓INFORMATION -----

- You can check a saved file with Ksfilemanager etc.

◆ Saving images displayed on a web page

1 When a web page is displayed, select an image (touch and hold)→[Save image]

- You can check saved images in Gallery (→P110) etc.

◆ Highlight & Copy texts on website

1 When a web page is displayed, slide the screen down to display the top of the screen→[Menu]→[Highlight & Copy]

- Alternatively, slide your finger from the slide spot at the bottom right of the screen to the center, and release your finger "Highlight & Copy" area.

2 Trace texts with your finger

- From here on, refer to "Highlight & Copy".→P55

◆ Printing web page

You can print a displayed web page using a Wi-Fi supported printer or the cloud print function. Set connection with a printer beforehand.→P169

1 When a web page is displayed, slide the screen down to display the top of the screen→[Menu]→[Print]

- From here on, refer to "Print".→P171

◆ Setting Browser

1 When a web page is displayed, slide the screen down to display the top of the screen→[Menu]→[Settings]

2 Set each item

General : Set home page displayed when Browser is activated or downloaded file saving location.

Privacy & security : Set cache, deleting browser history, displaying/hiding warning screen, Cookie, form data or current location information.

Accessibility : Set text size or minimum font size.

Advanced : Set search engine, Open in background, Enable JavaScript, Allow multiple tabs per app, Enable plug-ins, Website settings, PAGE CONTENT or Reset to default can be set.

- When [Auto-fit pages] in PAGE CONTENT is marked, text and other elements on web pages are automatically optimized to display.
Double-tapping text string adjusts the text to be fitted with the screen width.
- When [Open link always in current tab] of PAGE CONTENT is marked, links ("target="_blank", "window.open", etc.) that is set to open in a new tab opens in the current tab.

Bandwidth management : Set Web page preloading and Load images.

Labs : Set Disaster/Evacuation information or Fullscreen.

Applications

dmenu

In dmenu, you can easily access sites recommended by DOCOMO or convenient applications.

1 From the Home screen, [dメニュー (dmenu)]

Browser activates and "dmenu" appears.

- When the application selection screen appears, follow the onscreen instructions to select an application.

✓INFORMATION

- To use dmenu, Internet connection by packet communication (LTE/3G/GPRS) or Wi-Fi is required.
- For connecting dmenu and downloading applications introduced in dmenu, packet communication charge is applied separately. Some downloaded applications automatically perform packet communications.
- Applications introduced by dmenu may include charged ones.

dmarket

Various services including selling digital contents such as music, videos, books, shopping sites, travel reservation sites, etc. are provided.

1 From the Home screen, [dmarket]

Top screen of dmarket appears.

- For details on dmarket, refer to the following website.
<https://d.dmkt-sp.jp/common/about/index.html> (In Japanese only)

Play Store

With Play Store, you can access to Google Play to search convenient applications or fun games which you can download and install on the terminal. Also, movie contents can be rented to view.

- To use Google Play, you need to set up a Google account on the terminal. If a Google account is not yet set up, follow the onscreen instructions that are displayed when you open Play Store for the first time.
- Once you accept the installation of an application, you will be held responsible for its use. Be careful especially about applications which access many functions or large amount of data.
- Make sure the security of application, then install it at your own risk. The terminal may be infected with a virus and the data may be damaged.

- NTT DOCOMO is not liable for any malfunctions or disadvantage brought to you or any third party due to application which you installed and provided by a third party including Google Inc.
- For the application which you installed from Play Store and provided by the third party including Google Inc., contact each provider.
- For details about buying charged applications, returning the product, demand for refund, flick the left side of the Google Play screen to the right→[Help & feedback] to see help.
- Items or displays may vary depending on the version of the application.

◆ Installing application

1 From the Home screen, tap [Play Store].

Google Play screen appears.

2 Search an application→Select an application

3 [INSTALL] (for free application)/[Price] (for paid application)

- Check the displayed contents carefully and follow the onscreen instructions.
- Displayed items differ depending on the application.

4 Check the download progress

When installation is completed,  appears on the status bar.

✓INFORMATION

- Some applications automatically connect to the Internet and perform communications. Note that packet communications charge may be higher.
- The icon for the installed application is displayed on the Home screen or the application list screen.
- Installed accessibility plug-ins can be enabled from the accessibility.→P161

◆ Deleting Google Play application

1 On the Google Play screen, flick right the left edge of the screen→[My apps & games]

2 Select an application

3 [UNINSTALL]→[OK]

- When you uninstall a charged application, a screen for refund may appear. For details, in the Google Play screen, flick right the left end of the screen→Tap [Help & feedback] to see Help.

Osaifu-Keitai

You can use Osaifu-Keitai service which allows you to pay money or to use coupon only by holding the terminal over the IC card reader in stores etc. and "かざしてリンク対応サービス (Kazashite-Link compatible service)" which allows you to access information by holding the terminal over a home appliance, a poster, etc.

You can save electronic money and points to an IC card of the terminal. Also, you can check balance of electric money and point value on the screen. By locking Osaifu-Keitai functions, you can prevent the terminal from being used without your permission in case of theft or loss.

For details on Osaifu-Keitai, refer to NTT DOCOMO website.

- A setting from the dedicated website or application is required to use Osaifu-Keitai compatible services.



◆ Precautions on using Osaifu-Keitai compatible terminal

- Data in the IC card* may be lost or modified because of the malfunction of the terminal (when we repair your terminal etc., as we cannot repair it with data remained, you are required to erase the data yourself). For more information about reissuing and restoring data, and support for saving and transferring data, contact the Osaifu-Keitai compatible service provider. For important data, be sure to use an Osaifu-Keitai compatible service with backup service.

* Data saved in IC card installed to Osaifu-Keitai compatible terminal

- If the data in the IC card is lost, modified or damaged by any means related to Osaifu-Keitai compatible service such as malfunction or model change, DOCOMO assumes no responsibility for the loss of data.
- If the terminal is stolen or misplaced, immediately contact Osaifu-Keitai compatible service provider for an advice.



◆ Using "Osaifu-Keitai service"

- 1 From the Home screen,  → [Osaifu-Keitai]
 - If the initial setting has not yet made, the initial setting screen appears. Follow the onscreen instructions to set.
 - 2 Select a service
 - 3 Set up the service
 - Make the required settings from the service site or application.
 - 4 Hold  mark over a card reader
- ✓ **INFORMATION** -----
- When reading/writing data, you need not activate Osaifu-Keitai application.
 - Powering on the terminal is not necessary, but if the terminal remains powered off for a long time or battery is low, the function may not be available.
 - Note that Osaifu-Keitai compatible applications perform background communication necessary for providing the Osaifu-Keitai service regardless of the setting of Battery saver or Data saver of the terminal and that may incur packet communication charge. → P139 , P127

- Depending on Osaifu-Keitai compatible application or the setting condition, use of Osaifu-Keitai by holding over an IC card may not be available when the screen is locked, the screen backlight is off, or the terminal is turned off.
- For non-subscriber to sp-mode, a part of Osaifu-Keitai service may not be available.
- When the terminal is turned on or restarted, unlock the screen lock and then hold the terminal over an IC reader to use the Osaifu-Keitai service.

◆ Using "かざしてリンク対応サービス (Kazashite-Link compatible service)"

1 From the Home screen, → [Settings] → [Wireless & networks] → [NFC/Osaifu-Keitai Settings]

- When the password setting screen for NFC/Osaifu-Keitai lock appears, follow the onscreen instructions to set password.
- If [Lock NFC/Osaifu-Keitai] is marked, unmark the checkbox.
- Alternatively, from the Home screen,  → [Osaifu-Keitai] →  /  to display the "NFC/Osaifu-Keitai Settings" screen.

2 Mark [Reader/Writer, P2P]

3 Hold mark over a device equipped an NFC module, a smart poster, etc.

- In addition, you can exchange information between terminals using Android Beam. → P167

◆ Tap & pay

By holding the terminal over the IC card reader to select an available service.

- For using Tap & pay, on the Tap & pay screen, [MENU] → Tap [How it works] and read the displayed explanation.

1 From the Home screen, → [Settings] → [Wireless & networks]



2 [NFC/Osaifu-Keitai Settings] → [Tap & pay] Tap & pay screen appears.

◆ Notes when holding over the other device

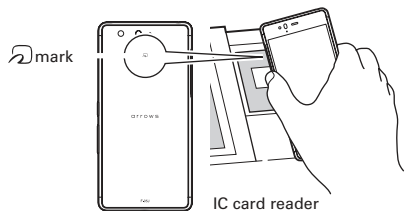
Pay attention to the following when holding the terminal over a card reader, NFC module equipped device, etc.



- Bring  mark close to the device slowly, do not hit it strongly.

- Hold  mark horizontally over the center of the compatible device. If scanning fails even with it held over the center of the scanner, slightly lift up the terminal, or move it backwards/forwards or to the left/right.
- If there are metal objects between  mark and the other device, scanning may fail. Putting the terminal into a case or cover may affect communication. In that case, remove the case or cover.

◆ Locking Osaifu-Keitai function

Lock the Osaifu-Keitai function not to allow others to use Osaifu-Keitai services or acquire data from scanners.

- Osaifu-Keitai lock is different from screen lock authentication or SIM card lock.

1 From the Home screen,  → [Osaifu-Keitai]

2 

- When the password setting screen of Osaifu-Keitai Lock Settings appears, follow the onscreen instructions and set a password.

3 [Lock NFC/Osaifu-Keitai] → Enter a password → [OK]

✓ INFORMATION

- While NFC/Osaifu-Keitai Lock is set,  appears on the status bar.
- Be careful about remaining battery level because canceling NFC/Osaifu-Keitai Lock becomes unavailable when the battery runs down while NFC/Osaifu-Keitai Lock is set. When the battery runs down, charge the terminal before canceling NFC/Osaifu-Keitai Lock.

- To use Osaifu-Keitai menu while NFC/Osaifu-Keitai Lock is set, cancel NFC/Osaifu-Keitai Lock.
- A lock password for NFC/Osaifu-Keitai cannot be erased even if you reset the terminal.

❖ Canceling lock

1 From the Home screen,  → [Osaifu-Keitai]

2 

3 [Lock NFC/Osaifu-Keitai] → Enter a password → [OK]

◆ iDアプリ (iD application)

"iD" refers to electronic money offered by DOCOMO. Once you have set up "iD" on your Osaifu-Keitai, you can hover the terminal over an IC card reader at various shops to make your shopping easier and more comfortable. You can register the information of up to two cards and use either one depending on the privilege.

- To use iD with your Osaifu-Keitai, you need to configure settings using the iD application.
- The charges required for iD service (including the annual charge) vary by card issuer.
- Setting up the iD application or checking its information overseas will incur packet communication charges that are different from those in Japan.
- For information on iD application, refer to iD website (<http://id-credit.com/> (In Japanese only)).

◆ ToruCa

The ToruCa application allows you to save coupons offered by your favorite shops and other useful information to your terminal. You can obtain by various ways such as mails, web download, Bluetooth function, IC tag, etc. You can easily update your ToruCa. You can easily update your ToruCa.

- For details of ToruCa, refer to NTT DOCOMO website.

✓ INFORMATION

- For obtaining, displaying or updating ToruCa, a packet communication charge may be applied.
- To obtain ToruCa by Bluetooth function, set Bluetooth of ToruCa application to ON.
- To obtain ToruCa from IC tag, mark [Reader/Writer, P2P] of the terminal. →P167
- Depending on the settings configured by the content provider, the following functions may not be available. Updating, sharing ToruCa, displaying map, obtaining from the IC card reader.
- You may not be able to obtain ToruCa with an IC card reader, if you do not make initial setting for Osaifu-Keitai.
- Note that ToruCa applications perform background communication necessary for obtaining ToruCa regardless of the setting of Battery saver or Data saver of the terminal and that may incur packet communication charge. →P139 , P127
- ToruCa using Bluetooth function, IC tag, or IC reader may not be obtained without unlocking the screen lock when the terminal is turned on.
- The screen backlight may light when you obtain ToruCa via Bluetooth function while the screen backlight is off.

1Seg

1Seg is a digital terrestrial TV broadcasting service for mobile devices that allows you to receive data programs along with video and audio. Also, interactive service using communication function of mobile devices and receiving detailed information are available.

- For details on "1Seg" service, refer to the website below.
The Association for Promotion of Advanced Broadcasting Services:
<http://www.apab.or.jp/en/>

◆ Using 1Seg

- 1Seg is a service provided by TV broadcast companies (broadcast stations). Receiving video and audio is free. For more information about NHK reception fees, contact NHK.
- Extend the 1Seg antenna fully when you watch 1Seg. →P98
- Information displayed in the area of data broadcasting is "data broadcasting" and "data broadcasting site" information.
"Data broadcasting" information is carried in a broadcast, together with images, voice and sound, and "data broadcasting site" information is used to access sites provided by the TV broadcaster (broadcast station). Packet communication charge is applied when accessing a site such as a "data broadcasting site" or others. Some sites require information charges to be used.

◆ About signal

1Seg is one of broadcasting services, and receives radio waves (broadcast waves) that are different from LTE service and FOMA service. For this reason, the signal cannot be received at places where the broadcast does not reach or while broadcasting is out of service, regardless of whether the terminal is outside or inside the LTE/FOMA service area. Also, in the following places, the signal status may become weak or the signal may not be received even if the terminal is inside the area of a terrestrial TV broadcasting service.

- Places that are far from the broadcast transmission tower
- Places where the signal is disrupted due to the landscaper or structures such as mountain areas or behind buildings
- Places where the signal is weak or does not reach, such as tunnels, basements, or places inside buildings

Extend the 1Seg antenna fully, and turn the antenna around and move to other place. Signal reception may be improved.→P98

■ 1Seg antenna

1Seg antenna receives broadcasting signals when you watch 1Seg.

- Make sure to extend the 1Seg antenna to the end when pulling it out.
- To turn the 1Seg antenna around, hold the part near the base of the 1Seg antenna. Do not put an excessive force.

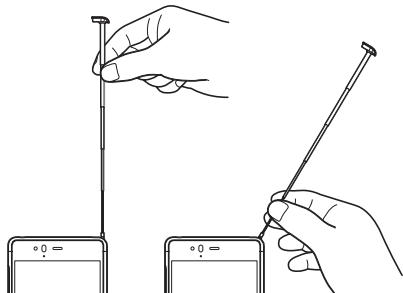

- To stow the 1Seg antenna, hold the part near the base of the 1Seg transmitter antenna and insert it until it stops. Do not hold the top end to stow.

◆ Activating 1Seg

1 From the Home screen, [1Seg]

The 1Seg viewing screen is displayed.

- When you activate the software for the first time, create a channel list corresponding to the watching area. → P102

Ending 1Seg :  (Back)

✓ INFORMATION



- The minimum battery power to start or continue operating is 6% (while charging, you can activate or continue operating regardless of the battery level).
- It may take a time to acquire image data or broadcasted data when you activate 1Seg or change channels due to characteristic of digital broadcasting.
- Depending on the signal strength, video or audio may be interrupted or stopped.
- When the terminal returns to the Home screen or goes into the sleep mode while receiving 1Seg program, the sound of 1Seg keeps coming out. To end Background play of the 1Seg, return to the 1Seg watching screen and tap  (Back).
- Video can be played back using the video correction engine by marking [Video correction] when watching in 1Seg. → P133
- Since 1Seg content is prohibited from copying, screenshot or Capture & Draw/Highlight & Copy is not available.

❖ 1Seg watching screen



1Seg watching screen

- ① **Operation area**
 - The screen rotation and menu icon are displayed.
- ② **TV watching area**
 - Flick left or right to switch channels.
- ③ **Subtitle/Data broadcast area**
 - Display the subtitle/broadcast data. To operate data broadcasting, touch the screen to operate or tap control icons displayed below the data broadcast area.
- ④ **Channel information area**

Channel name, signal reception, and program name are displayed.
- ⑤ **Navigation bar**
- ⑥ **Controller**
 -  /  : Switch the channel (Touch and hold to perform a channel search)
 -  : Pop-up the list of channels

- If an unregistered broadcasting station is found by the channel search, you can display the list of channels→ Touch and hold an empty channel→ Tap [YES] to add the station to the channel list.
 - To add the station channel you are watching, display the channel list→ Touch and hold the channel→ [Overwrite registered channel]*→ [YES].
- * This operation is not required when you touch and hold the empty channel.
- To delete the station from the channel list, display the channel list→ Touch and hold the registered channel→ [Delete channel]→ [YES].

✓ INFORMATION

- You can adjust the volume by pressing the volume key when the 1Seg watching screen is displayed.
- On the horizontal screen, the content is displayed full-screen. Tap the screen to show the operation area, channel information area, controller, and navigation bar.

◆ TV link

For some data broadcasting programs, link information to related websites (TV link) is displayed. Save TV links to display related websites directly.

❖ Registering TV link

1 Select an item that can be registered as a TV link in the data broadcast area

- Procedure to save TV link varies by the program.

❖ Displaying TV link

1 On the 1Seg watching screen, ■→ [TV link]→ Select TV link→ [YES]

Connect to the saved website.

❖ Deleting TV link

1 On the 1Seg watching screen, ■→ [TV link]

2 Touch and hold a TV link→ [Delete]→ [YES]

To delete all the TV links : ■→ [Delete all]→ [YES]

◆ Reserving watching

You can reserve watching TV programs.

1 On the 1Seg watching screen, ■→ [Reserve Viewing]

A reservation list appears.

2 ■→ [New reservation]

3 [From Program guide]/[Viewing reservation]

- If you select [From Program guide], follow the onscreen instructions.

4 Set required items→ [Save]→ [YES]

- When the confirmation screen related to the functions available for users and guests, tap [OK]. If [Do not display from now on] is unmarked, the setting screen will not be displayed from next time.

❖ INFORMATION

- If you turn the terminal OFF, the schedule will not be executed.
- If you selected [From Program guide] and the application update screen appeared in Step 2, follow the onscreen instructions.
- When users or guests are using, Reserve Viewing is not available. If the Reserve Viewing time comes while it is switched to users or guests, Reserve watching is not performed.

❖ Checking reservation

Check your reservation.

1 On the 1Seg watching screen, ■→[Reserve Viewing]

A reservation list appears.

2 Tap a reserved item

- On the reservation list, touch and hold a reservation item→Tap [Edit] to edit contents.
- On the timer list, touch and hold a reservation item→[Delete]→Tap [YES] to delete 1 reservation item.

❖ Check the result of the failed reservation

When a reservation is failed, you can check details of the result of the reservation.

1 On the 1Seg watching screen, ■→[Reserve Viewing]→■→[Failed Reservation List]

The list of failed reservation appears.

2 Tap an item of the result of the reservation

- On the failed reservation list, touch and hold a reservation result→[Delete]→Tap [YES] to delete 1 timer item.

❖ 1Seg settings

1 On the 1Seg watching screen, ■→[Settings]

2 Set required items

Data Broadcasting settings : Configure settings for when data broadcasting is displayed (Use location info, Use device info, and Delete station memory).

Auto Exit Timer : Set time period after which TV is turned off (OFF/10 min./30 min./60 min./90 min./120 min.).

Notes : Display the information of terms of use.

❖ Subtitle/Sound setting

1 On the 1Seg watching screen, ■→[Subtitle/Sound setting]

2 Set required items

Display subtitles : Set whether to display subtitles.

Subtitle position : Set the position of subtitles for the horizontal screen.*¹

Subtitle language : Set the language for subtitles.*²

Sound output : Set from [Main]/[Sub]/[Main/Sub] for listening.*²

Audio language : Set the language for sound.*²

*1 You can set only while watching in the horizontal screen.

*2 You can set only when the program is available for the function.

◆ Setting the channel

❖ Creating channel list

1 On the 1Seg watching screen,  → [Change area]

2 Touch and hold an unregistered item → [Area info setting] → Select the region, prefecture, and area

3 [OK]

❖ Switching channel list

1 On the 1Seg watching screen,  → [Change area] → Select channel list

Camera

◆ Cautions on shooting

- Although the camera is manufactured using extremely high-precision technology, it may contain dots or lines that are always lit or that do not light. When shooting under low light conditions, in particular, white lines or random color dots are likely to appear as noises. This is not a malfunction.
- When activating the camera, white stripes may appear on the screen. This is not a malfunction.
- When the terminal is in high temperature state for a long time, the camera may not be available. Wait until the terminal cools down to use again.
- When the battery is low, the camera may not be available. Fully charge the terminal before using the camera.
- The captured images may be different from actual objects for color and brightness.
- If you try to shoot an object in an environment with intense light source like the sun etc., the images may be dark or noisy.
- Fingerprints or body oil on the lens can affect images. Wipe with a soft cloth before shooting.
- The battery consumption is faster when using the camera.
- When the battery is low, lighting volume for flash may be limited.
- If you do not operate for approximately 2 minutes during stand-by,  appears on the status bar.
- When you are approximately 10 cm or more away from an object, the camera automatically focuses on the object according to the set scene mode.

Copyrights and portrait rights

Avoid reproducing, altering, or editing taken or recorded pictures or sounds using the terminal without the copyright holders authorization, because, except for personal use etc., they are prohibited by the Copyright law. Avoid using or altering pictures of others without their consent, because they may infringe on portrait rights.

Note that taking photos or recordings at some demonstrations, performances or exhibitions may be prohibited even when only for personal use. Please be considerate of the privacy of individuals around you when taking and sending photos using camera-equipped mobile phones.

If you cause the public any trouble using the terminal, you may be punished under law or regulations (for example, nuisance prevention ordinance).

◆ Viewing shooting screen



Still image shooting screen



Video shooting screen

- 1 Flash icon**
 - An icon appears showing the setting of the flash. →P106
- 2 Location information icon**
 - It appears when location information is set to be added. →P107
- 3 White balance adjustment icon**

Adjust white balance. Icons indicating the settings of white balance appear at the side of the icon.
- 4 Exposure correction icon**

Adjust exposure correction. Icons indicating the settings of exposure correction appear at the side of the icon.
- 5 Menu icon**
 - It does not appear during video recording.

- ⑥ **Still images/videos that was taken immediately before**
 - Tap to check a still image/video that is taken immediately before. Before shooting, a still image or video is not displayed.
- ⑦ **Shutter button**
- ⑧ **Focus frame**
 - When the face is not detected, the camera automatically focuses on the center of the screen to show the focus frame. When the face is detected, the camera automatically focuses on the face to show the face detection frame.
- ⑨ **Switch cameras**

Switch to in-camera/out-camera.
- ⑩ **Indicator**

Indicates the current shooting mode is still image shooting (left)/video shooting (right).
- ⑪ **Start recording button**

✓ **INFORMATION** -----

- If confirmation screen for switching save destination appears when the camera is activated, tap [NO]/[SWITCH].
- When available memory space is reduced, remaining recordable numbers for shooting still images and remaining recordable time for shooting videos are displayed on the shooting screen.

◆ **Shooting still images**

1 **From the Home screen, [Camera]**

A still image shooting screen appears.

2 **Display an object on the shooting screen** →

Shutter sound is heard and a still image is shot.

- You can also shoot a still image by pressing the lower part of the volume key.

■ **Main operations on the still image shooting screen**

Zooming : Pinch-in/Pinch-out the screen

- Pinch-in/pinch-out to show a slide bar. You can zoom in/out using the slide bar. Zoom function is not available for in-camera.

Switching to in-camera/out-camera : On the shooting screen,



Switching to the video shooting screen : Flick the shooting screen left

- To return to the still image shooting screen, flick the video shooting screen right

◆ **Continuous shooting**

You can shoot continuously up to 100 images.

- Continuous shooting mode is not available for shooting with in-camera, shooting with HDR mode, flash or self timer settings.

1 **From the Home screen, [Camera]**

2 **[MENU] → [RapidPic]**

Continuous shooting screen appears.

3 Display an object on the shooting screen →

Touch and hold ■

While pressing ■, continuous shooting and saving are kept. When you release the finger from ■, continuous shooting ends.

- You can also shoot images continuously by holding down the lower part of the volume key.

■ Main operations on the continuous shooting screen

Zooming : Pinch-in/Pinch-out the screen

- Pinch-in/pinch-out to show a slide bar. You can zoom in/out using the slide bar.

Switching to the video shooting screen : Flick the shooting screen left

- When you flick the switched video shooting screen right, the still image shooting screen appears.

✓ INFORMATION -----

- Continuous shooting stops when saving destination becomes low on memory.
- In continuous shooting mode, you can set the picture size (3M 2048×1536/FullHD 1920×1080/Mobile email 640×480), Location, Save, Touch shutter, Display grid, and Exposure/WB. →P106

◆ Panorama shooting

You can shoot a panoramic image by slowly swiveling the camera to the left or right.

- Panorama shooting is not available for in-camera.

1 From the Home screen, [Camera]

2 [MENU]→[Panorama]

3 Display an object on the shooting screen → ■

(Start)

Shooting start sound is heard and a shooting is started.

- You can also start shooting by pressing the lower part of the volume key.
- If you move the camera too fast, "Too fast" appears. Move the camera so that the message does not appear.

4 ■ (DONE)

Shooting end sound is heard, shooting stops and a panorama image is saved.

- You can also stop shooting by pressing the lower part of the volume key.
- When the shooting is finished while moving the camera, the shooting end sound does not sound.

■ Main operations on the panorama shooting screen

Closing the panorama shooting screen : [BACK]

- Return to the previous shooting mode before setting to the panorama shooting screen.

◆ Automatic still image shooting

The terminal automatically adjusts settings and shoots pictures in the following functions.

- Image stabilizer is always turned on.

■ Omakase Auto focus

When the distance from an object is approximately 10 cm or more, the camera automatically focuses on a pointed object.

- When an object includes people, face detection frame appears first to be focused on.

■ Touch focus

Tap an object on the shooting screen to automatically focus on. With [Touch shutter] set to ON, the camera makes an auto focus lock sound when the object comes into focus, and takes the picture as it makes a shutter sound.

■ White balance

Automatically adjust for shooting in natural color shade under various sources of light (sunlight, cloudy sky, artificial source of light such as incandescent or fluorescent).

■ Scene mode

Automatically recognize according to object and circumstance and switch suitable shooting mode.

- When QR code is displayed, QR code is scanned and results are shown.

■ Automatic exposure

Automatically adjust exposure according to the ambient lighting. When face detection frame of auto focus appears, exposure is fixed based on the brightness of face. If you want to use an object as the base, tap the object to fix the exposure. The object is given priority even if a face is detected.

■ Adjust flicker

Reduce flicker noise or stripe pattern emerged under a fluorescent lamp etc.

◆ Shooting settings for still image

Tap [MENU] displayed on the still image shooting screen to change the following shooting settings.

- Some items cannot be selected depending on the combinations.
- Some items cannot be set for the in-camera.
- If the Camera is activated from other than the Home screen or the application list screen, some settings are unavailable.

■ Camera Mode



Tap Still/RapidPic/Video/Panorama/QR code to select a camera mode.



■ Picture Size

Select shooting size.

- When you activate Camera from other application such as phonebook, an image size may change temporarily to [Fit screen 1920×1080].

■ Flash

Select Flash setting from auto flash ()/flash ()/off (). If auto-flash is set, when the camera determines that lighting is insufficient, the flash automatically lights.



- If flash () is set, the icon is always displayed on the still image shooting screen. If auto flash () or off () is set, the icon is displayed on the still image shooting screen when the camera determines that lighting is insufficient. You can change the settings by tapping the displayed icon.
- If "RapidPic" or "HDR mode" is set, the flash cannot be set. Also depending on the night scene, it may not turn on.

■ HDR mode

Shoot 2 images in different exposure time (long exposure and short exposure) and compose a still image that white out or crushed blacks is reduced.

- The real-time HDR is equipped with the terminal, so you can check the status of composited HDR on the shooting screen during shooting.



■ SelfTimer

Set to shoot a picture 2 seconds (, 3 seconds (, or 5 seconds () after the shutter is pressed.

■ Display grid

Set to display auxiliary lines (grid) on the shooting screen as an assistant for photo composition.

■ Others



Location : Set to add location information to shot images. When location information is set to be added, icon of  for obtaining location information (not obtained) appears, then  for completion of obtaining appears on the shooting screen.

Save : Select data saving location (Terminal/SD card).

- If the selected saving destination is low on memory, a message appears and switch saving destination temporarily (except during continuous shooting).

Touch shutter : Set to shoot with auto focus lock sound and shutter sound by tapping an object when the object is focused on.

- In continuous mode, only one image is shot.

Exposure/WB : Set whether to display the icons for exposure correction () /white balance adjustment () on the shooting screen.

◆ Shooting video

1 From the Home screen, [Camera]

2 Flick the screen left

A video shooting screen appears.

3 Display an object on the shooting screen → (Start)

Shooting start sound is heard and a shooting is started.

- You can also start shooting by pressing the lower part of the volume key.
- When shooting starts, elapsed time appears on the shooting screen.

4 (Stop)

Shooting end sound is heard and a shooting stops.

- You can also stop shooting by pressing the lower part of the volume key.
- Recording stops when saving location become low on memory or when file size of recorded data reaches the limit (approx. 4 GB). Also, recording stops when a call is received while recording.

■ Main operations on the video shooting screen

Shooting still image while recording : Tap  shown while recording a video.

- The shutter sound is not emitted for still image shooting while recording video.

Zooming : Pinch-in/Pinch-out the screen

- Pinch-in/pinch-out to show a slide bar. You can zoom in/out using the slide bar. Zoom function is not available for in-camera.
- Zoom function is available while recording.

Switching to in-camera/out-camera : On the shooting screen



Switching to the still image shooting screen : Flick the shooting screen right

- To return to the video shooting screen, flick the still image shooting screen left.

◆ Automatic video recording

The terminal automatically adjusts settings and records video in the following functions.

- Recording voice is always turned on.

■ Auto focus

Focus on the center of the screen when recording starts.

■ Touch auto focus

Before or while recording, touch the object on the shooting screen to display the focus frame and focus on the object automatically.

■ White balance

Automatically adjust for shooting in natural color shade under various sources of light (sunlight, cloudy sky, artificial source of light such as incandescent or fluorescent).

■ Adjust flicker

Reduce flicker noise or stripe pattern emerged under a fluorescent lamp etc.

◆ Shooting settings for video

Tap [MENU] displayed on the video shooting screen to change the following shooting settings.

- Some items cannot be selected depending on the combinations.
- Some items cannot be set for the in-camera.

■ Camera Mode

Tap Still/RapidPic/Video/Panorama/QR code to select a camera mode.

■ Movie Size

Select shooting size.

■ Light

Set whether to automatically turn on the flash when recording in a dark place.

■ Save

Select data saving location (Terminal/SD card).

- If the selected saving destination is low on memory, a message appears and switches saving destination temporarily (recording stops during video recording).

■ Exposure/WB

Set whether to display the icons for exposure correction (☒)/white balance adjustment (WB) on the shooting screen.

◆ QR code reader

Scan QR code data and use it.

- QR code cannot be scanned for some versions (type and size).
- Scratches, dirt, damages, low print quality and the strong reflection of light may disable code reading.

❖ Reading with QR code reader

- Scan using the camera with the distance of approximately 10 cm or more from an object (QR code).
- If the QR code is not scanned well, try to change the distance between the QR code and camera, the angle or direction of camera.

1 From the Home screen, [Camera]

2 [MENU]→[QR code]

The QR code shooting screen appears.

3 Display a QR code on the shooting screen→Scan

A confirmation sound is played when scanning is complete and the scanned data appears.

Scanning divided data :

One data item divided into multiple (up to 16) QR codes can be scanned and be displayed as a combined data.

Continue reading if unscanned data exists.

Closing the QR code shooting screen : [←]

- Return to the previous shooting mode before setting to Reading with QR code reader.

Turning the light ON/OFF : [MENU]→[Light ON]/[Light OFF]

4 Check scanned data

Saving data : On the scanned data, [MENU]→[Save to history]→Tap history field

Displaying history : On the QR code shooting screen, [MENU]→[History]→Select a history

❖ Using QR code data

Use the scanned QR code data.

- Displayed menu options may vary depending on the scanned data.

Saving all data in the phonebook : [MENU]→[Batch register contacts]→Save in the phonebook

Creating mail : Select mail address to create a message→Create a mail

Connecting to the website or home page : Select URL

Making a call : Select a phone number→

Gallery

You can view still images or videos shot with the camera or downloaded to the terminal.

- The following file types of data can be displayed/played. However, some files may not be viewed/played back.
Still image : JPEG, BMP, GIF*, PNG, WEBP
Video : H.263, H.264, H.265, MPEG-4, VP8, VP9
* GIF animation cannot be played.

◆ Viewing still image/Playing video

1 From the Home screen, [Gallery]

2 Select an album







The data list screen is displayed.

- Tap [Filmstrip view]/[Grid view] at the upper of the screen to switch the display.

3 Select an image

- Flick the screen left and right to switch between the previous and next screen.
- Pinch-out/Pinch-in to zoom in/out.
- For video, tap  to play. Press the volume key to adjust sound volume, or with displayed icon or slider, play, pause, fast-rewind, fast-forward, etc.

■ Main icons and functions

-  : Saving destination is the phone memory
-  : Saving destination is microSD card
-  : Activate camera
-  : Send or share an album/image
-  : Delete album/image
-  : [Slideshow]/[Edit] etc.
-  : Correct or edit still images
- Displayed items vary depending on the displayed screen or operation status.
- Some files may not be moved/copied.
- * Touch and hold an album/image on the album list/image list to display.

◆ Categorizing and viewing images

- Tap [Albums] in the album list to switch display of images categorized by Album, Location, or Times.

◆ Selecting album/image



- Touch and hold an album/image on the album list/image list to display check mark at the album/image. Frame in light blue appears on the image and the image is in selected status. Tap to deselect.
- When albums/images are selected, number of selected items is displayed at the top of the screen. Tap a number of selected items to operate [Select all]/[Deselect all].

✓INFORMATION -----

- In the album list, you can brighten the images by tapping [Menu]→[Settings]→Marking [Brightness up].

Media Player

You can use the Media Player to play music/video and music/video contents downloaded from dmarket.

- Playable audio file formats and codecs are AAC, HE-AAC v1, HE-AAC v2, AAC ELD, AMR-NB, AMR-WB, FLAC, MP3, MIDI, Vorbis, PCM, and Opus. Playable video file formats are H.263, H.264, H.265, MPEG-4, VP8, and VP9. However, some files may not be played back.
- Files in MIDI format and received files cannot be displayed in the list. Playing is possible when the file is selected in other application etc.
- For details on how to transfer music/video files to the microSD card from a PC, see "Operating data on the terminal from a PC". →P169
- To check operations of the Media player, from the Home screen, tap  → [Media Player] →  → [Help].

◆ Playing music/video

1 From the Home screen, → [Media Player]

- If an explanation screen for Media Player appears, tap [使い方の説明を見る (Check user guide)] or [使ってみる (Use)].

2 [Songs]/[Artists]/[Albums]/[Movie]/[Playlist]/[Ringtone]

List screen appears.

3 Select a song/video



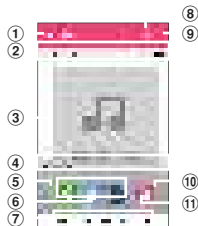

A play screen appears.

- When you select [Artists]/[Albums], select artist name/album until music/video you want to play is displayed.

■ Play screen



Music play screen

- 1 Displaying the list screen (music play screen only)
- 2 Playback point
 - Drag  left or right to change the playback point.
- 3 Album artwork (music play screen only)
- 4 Volume control*
 - Drag  left or right to control volume.
- 5 Repeat (music play screen only)
 - Each time tap, the mode switches for Repeat is off () → Repeat all songs () → Repeat current song ()
- 6 SNS sharing*
Share the music information using LINE, Twitter or Facebook.

⑦ Playing operation

⏸ / ▶ : Pause/Play

⏮ / ▶ : Play previous/next file

- Go back to the top of the file depending on the operation status.

⏮ / ▶▶ : 10 seconds fast-rewinding/10 seconds fast-forwarding

⑧ Search

Search music/video files on dmarket.

⑨ Display submenu

Operate Settings, Display/Delete contents, Help, to beginners, Exit, etc.

⑩ Shuffle on/off (music play screen only)

⑪ Album information*

- * Tap the album artwork to display the icons.

✓ INFORMATION

- Tap / on the video playing screen to enable/disable rotate screen lock.
- Tap → [Yes] on the video playing screen/video list screen to display Miracast settings screen. → P171
- To display the video list screen, tap on the video playing screen.
- To delete music/video, on the play list screen, touch and hold music/video → Tap [Delete content] → [OK] → [OK].

◆ Purchasing from dmarket

1 From the Home screen, → [Media Player]

2 → [d music]/[dTV]/[d anime store]

◆ Using Play list

Register songs to the play list to play songs only you like.

1 From the Home screen, → [Media Player] → [Playlist]

Play list screen appears.

2 [Add] → Enter the play list name → [OK]

3 Select a song to add to the list → [Done]

- Tap [Songs]/[Artists]/[Albums] to switch the display.
- Tap [Songs] → [Add all songs] to select all songs.

4 [Save] → [OK]

✓ INFORMATION

- Select a play list on the play list screen → Select a song to play.
- To sort play lists, on the play list screen, [Reorder/Delete] → drag up or down of the play list you want to move → [Save] → [OK].
- To delete a play list, on the play list screen, touch and hold a play list → [Delete playlist] → [OK].
- To edit a play list, on the play list screen, select a play list → [Edit].
- To delete songs from the play list, [Edit] in the song list of play list → Select songs → [Delete selected songs] → [Save] → [OK]. Also, in the song list of play list, touch and hold a song → [Delete from playlist] to delete a song.
- To change order of songs, drag of song up or down.

Location data/GPS

You can use the GPS function on the terminal and a compatible application to check your current location or search for routes to your destination.

- The terminal is equipped with GPS receiver using satellite signal for measuring current location. When using GPS function, a packet communication charge may be applied.

◆ Using the GPS function

- Note that DOCOMO is not liable for any damages that may occur as a result of irregularities in the GPS system.
- Note that DOCOMO is not liable for pure economic loss if you cannot confirm the positioning (communication) result with the terminal because of failure, malfunction or external factors such as power failure (including battery exhaustion).
- You cannot use the terminal as a navigation system for aircraft, vehicles, persons, etc. For this reason, note that DOCOMO is not liable for losses incurred by navigation performed by using location information.
- You cannot use the terminal as a high-accuracy measurement GPS. Note that DOCOMO shall have no liabilities whatsoever even if you suffer damage or loss due to a deviation of the location information.
- GPS is a service operated by the USA Department of Defense, so the GPS radio wave condition may be controlled (accuracy degraded, radio wave suspended, etc.) for reasons of US national security.
- Wireless communications products (mobile phone or data detector, etc.) may intercept satellite signal and signal reception may not be stable.

- The displayed map based on the acquired location information (latitude and longitude information) may be inaccurate because of the legal system in each country and area.

■ Where radio waves are difficult to receive

Note that since GPS is using radio waves for satellites, under the following conditions, radio waves might not be able to be received or might be difficult to receive. Also, do not cover the GPS antenna (→P29) with your hand.

- Inside or immediately under a building
- Inside a basement or tunnel, and below the ground or water
- Inside a bag or box
- In buildings-clustered or residential area
- Inside or under a thick covering of trees
- Near a high-voltage cable
- In a car, inside a train compartment
- Bad weather such as heavy rain or snow
- When there are obstructions (people or objects) near the terminal

◆ Precautions for using electronic compass

An electronic compass is equipped with the terminal and it senses the faint fluctuation in the magnetic field of the earth to calculate directions.

- The electronic compass calculates directions by sensing the faint fluctuation in the magnetic field of the earth. Therefore, the magnetic field may not be sensed or a direction may not be displayed correctly when the terminal is used inside or near buildings (including underground shopping area), vehicles, metal facilities (an elevator etc.), metal equipment (a guardrail, pedestrian bridge, etc.), high-tension wires, wires, rocks containing magnetism, metal (metal desk, locker, etc.), permanent magnet (a magnetic necklace, bag fastening, etc.), home appliances (a TV, computer, speaker, etc.).
- When an applications such as "Maps" cannot calculate directions correctly, adjust the electronic compass.

◆ Adjusting the electronic compass

■ Operation method

While using an application such as "Maps" that uses the electronic compass, move the terminal like describing a big figure of eight, twisting your wrist for around 10 seconds.



◆ Setting Location

Allow applications to use location information.

- Items or displays may vary depending on the version of the application.

- 1** From the Home screen,  → [Settings] → [Location/Accounts] → [Location]
- 2** Tap the button at the upper right of the screen to turn [Location] to ON
The user agreement screen appears.
- 3** [AGREE]
- 4** [Mode] → Select a mode

✓INFORMATION

- To measure highly accurate location information, use GPS in a place with sky view.
- Note that this function increases power consumption.

◆ Google Maps

The Google Maps™ application lets you measure your current location, find locations and calculate routes.

- To use Google Maps, a network connection via LTE/3G/GPRS network or Wi-Fi is required.
- To measure your current location, turn [Location] ON in advance.→P114
- Google Maps do not cover all countries and cities.

1 From the Home screen, [Google]→[Maps]

- For operations of Google Maps, flick right the left edge of the screen to refer Help or Tips and Tricks.
- When the confirmation screen for changing location information settings and accuracy for measuring current location, follow onscreen instructions.

Schedule

You can manage your schedule.

1 From the Home screen, [ドコモクラウド (docomo cloud)]→[Schedule]

The calendar screen appears.

- If a screen for access to cloud services appears, tap [クラウドサービスを設定する (Set cloud service)] or [後で設定する (Not now)].

◆ Registering schedule

1 On the calendar screen,

- To set alarm etc., tap [ Display input option].

2 Set required items→[Save]

Schedule is registered.

❖ When the notification date/time is reached

If you set alarm when registering schedule,  appears on the status bar when set date/time is reached.

1 Open the Notification panel→Tap the notification

Detailed screen appears.

◆ Displaying schedule

Display information of registered schedule.

1 On the calendar screen, tap a day → Tap a schedule

2 Check the schedule

Editing schedule : [Edit] → Edit schedule → [Save]

Deleting schedule : [] → [Delete one] → [DELETE]

✓INFORMATION

- To make settings etc., on the calendar screen, tap []
- To jump to specified date etc., on the calendar screen, tap []

Clock

You can use the alarm, clock, timer, stopwatch and world clock.

◆ Displaying the clock

1 From the Home screen, [] → [Clock]

The clock screen is displayed.

✓INFORMATION

- To display the world clock on the clock screen, Tap [CITIES] → Mark cities.
- Tap [MENU] on the clock screen to set "Night mode" or make settings for the clock.

◆ Using alarms

1 From the Home screen, [] → [Clock]

2 [ALARM]

The alarm screen is displayed.

3 [ADD] → Set time → Set each item

Switching ON/Off of alarm : Tap the button at the right of alarm time to set ON/OFF

Editing an alarm : [] of the alarm to be edited → Set each item

Deleting an alarm : [] of the alarm to be deleted → []

- Tap [UNDO] immediately after deleting to restore the deleted alarm.

✓ INFORMATION

- On the alarm screen, tap [MENU]→[Settings] to make settings for the clock.

◆ Using timers

1 From the Home screen, →[Clock]

2 [TIMER]

The timer screen appears.

3 Enter time→[START]

The countdown starts.

4 When the countdown ends, [STOP]/[ADD 1 MIN]

Pausing the countdown : During the countdown, [STOP]

- To restart the countdown, tap [START].

Resetting the countdown : While pausing the countdown,



Deleting a timer : 

Adding a timer : →Enter time→[START]

- Slide up or down the timer screen to display another timer.

Adding 1 minute : During the countdown, [+1']

Add 1 minute for countdown every time it is tapped.

◆ Using stopwatch

1 From the Home screen, →[Clock]

2 [STOPWATCH]

The stopwatch screen is displayed.

3 [START]

The measurement starts.

Adding a lap time : While measuring, 

Pausing the measurement : While measuring, [PAUSE]

- To restart the measurement, tap [START].

Resetting the measurement : While pausing the measurement, 

Sharing the result : While pausing the measurement, 

Calculator

1 From the Home screen, tap  → [Calculator]

2 Calculate

Deleting the input numbers and symbols : [DEL]

Deleting all mathematical expressions : [DEL] (Touch and hold)/[CLR]

Displaying the function pad : Slide left the right end of the pad

- Alternatively, tilt the terminal horizontal to display the function pad.

✓ **INFORMATION** -----

- When calculation result is displayed, you can add a mathematical expression to the result.

Search

You can search using "Google" application or "Voice Search" application.

- Items or displays may vary depending on the version of the application.

◆ **Google Search**

You can search in the website by entering keywords. Also, you can use the feed to check the information related to your current location (weather, traffic condition, etc.).

1 From the Home screen, [Google] → [Google]

- When you activate the application for the first time, the use of feed screen appears. Follow the on-screen instructions.

2 Enter a keyword

Search suggestions appear according to the character entry.

- Enter characters and tap  to display search suggestions in the website.

3 Select from search suggestions.



◆ Voice Search

You can search in the website by entering keywords by voice.

1 From the Home screen, [Google]→[Voice Search]→Speak a keyword to the microphone

2 Select a search suggestion from the website

✓INFORMATION

- For details on Google search and the feed, flick the left end of the Google Search screen right→Tap [Help] to see the Help.
- When the Home application is set to "NX!Home", you can search with handwritten word by tapping  on the Home screen→. Settings of search target of handwriting search are as follows.

On the handwriting search screen, [SETTINGS]→Mark search target

- Depending on the settings of [Set handwriting search], search words in one-byte alphanumeric character may not be included in the search result.
- When entering characters by handwriting, search candidates are displayed in "APP" tab and "OTHER" tab.

docomo Data Copy

"docomo Data Copy" application allows you to copy the data saved to the terminal to the other terminal or back up/restore the data.

Use this application for transferring the data when changing the model or for the regular backup of important data.

◆ Data transfer

You can copy the phonebook entries, images, etc. directly to the destination device using the one-to-one direct communication which does not use the internet.

Activate "Data Copy" applications on both a data sending terminal and a copy destination terminal, then align the two terminals.

1 From the Home screen, →[Data Copy]→[Data transfer]

- Follow the on-screen instructions.
- This application is needed for both a data sending terminal and a copy destination terminal. If it is not installed, download from NTT DOCOMO website.
- Communication method differ depending on your model or the OS.
- For the supported models or detailed use method, refer to NTT DOCOMO website.

◆ Backing up to/Restoring from microSD card

You can transfer or back up data such as phonebook entries or images using a microSD card.

- Do not remove the microSD card from the terminal or turn off the terminal while backing up or restoring. The data may be damaged.
- If phonebook item names (e.g. phone number, etc.) of the other terminal are different from ones of your terminal, the item names may be changed or deleted. Also, some text may be deleted in copied destination, because character type that can be saved in the phonebook varies by terminal.
- The phonebook data in docomo account and registered to the terminal can be backed up.
- When backing up the phonebook entries to a microSD card, the data without Name registered cannot be copied.
- If the microSD card is low on memory, backup may not be done. In that case, delete unnecessary files to make available space.
- If the battery is low, backup or restoration may not be done. In that case, charge the terminal and retry to back up or restore.
- You can back up only the data such as still images and movies stored in the terminal with this application. The data stored in a microSD card cannot be backed up.

◆ Backup

Back up the phonebook data, media files, etc.

1 From the Home screen,  → [Data Copy] → [Backup & Restore]

2 [Backup] → Mark data to back up → [Start backup] → [BACKUP]

The selected data is saved to the microSD card.

3 [Back to top]

◆ Restoring

Restore the phonebook data, media files, etc. backed up to a microSD card to the terminal.

1 From the Home screen,  → [Data Copy] → [Backup & Restore]

2 [Restore] → [Select] to the data type → Mark the data to restore → [Select]

3 Select the restoration option → [Start restore] → [RESTORE]

- Depending on data type, selecting the restoration option is not required.
- The selected data is restored to the terminal.

4 [Back to top]

❖ Copying phonebook data to docomo account

Copy phonebook data saved to your Google account or the terminal to your docomo account.

1 From the Home screen,  → [Data Copy] → [Backup & Restore]

2 [Phonebook account copy] → [Select] of phonebook to copy → [Add]/[OVERWRITE]

The copied contacts are saved to your docomo account.

3 [OK]

◆ Backing up to/Restoring to docomo cloud

Use the cloud (Data storage BOX) to back up or restore the call history or music.

1 From the Home screen,  → [Data Copy] →  → [Backup/Restore to Cloud]

2 [Backup]/[Restore]

- Follow the on-screen instructions.
- If you do not log in to the docomo cloud, the confirmation screen appears.

✓ INFORMATION

- Periodical backup is not executed at the specified time while the screen is locked or the emergency mode is running and will be executed when activating the function is available next time.
- Note that the packet communication charge may become high for using the periodical backup to the cloud.

Settings

Setting menu

Make various settings from the Settings menu.

1 From the Home screen, → [Settings]

The 12 categories are displayed (TILE).

- Tap [LIST] to display the Settings menu in the list. To return to the tile display, tap [TILE].
- Tap [SEARCH] to search the item of the Settings menu.

Category	Page	
Display/Sound/ Apps	Display & Wallpaper	P133
	Notifications	P135
	Sound	P136
	Apps	P138
	Storage	P139
	Memory	P140
	Gestures	P141
Location/ Accounts	Location	P114
	Accounts	P154
	Backup & reset	P157
Battery	P139	

Category	Page	
Wireless & networks	Wi-Fi	P123
	Bluetooth	P164
	NFC/Osaifu-Keitai Settings	P95, P167
	Airplane mode	P128
	Tethering	P129
	VPN	P130
	Cellular networks	P131, P173
Network settings reset	P132	
Data usage	P127	
Security	P143	
Google	P155	
Languages & input	P155	
Useful tools	P158	
docomo service/cloud	P142	
Users	P140	
System	Date & time	P160
	Accessibility	P161
	Printing	P169
	About phone	P161

✓INFORMATION

- "Suggestions" may be displayed in the top of the list to prompt you to make setting depending on the terminal usage.

Wi-Fi

With Wi-Fi functions of the terminal, you can use mail or access the Internet by connecting to the home or company network or public wireless LAN access point.

To connect to a LAN access point, you need to set connection information.

■ Reception interference caused by Bluetooth

Wireless LAN (IEEE802.11b/g/n) and Bluetooth function use the same frequency band (2.4 GHz). If you use the wireless LAN function and Bluetooth function of the terminal at the same time, reception interference may occur and the communication speed may lower. Also, you may hear noise or have a connection problem.

Even when you use only wireless LAN function of the terminal, the same problem may occur when someone uses a Bluetooth device near you. In this case, do the following.

- Keep the terminal over 10 m away from a Bluetooth device.
- If you use the terminal within 10 m, turn off the Bluetooth device.

◆ Connecting to network with Wi-Fi ON

1 From the Home screen,  → [Settings] → [Wireless & networks] → [Wi-Fi]

2 Tap the button at the upper right of the screen to turn [Wi-Fi] to ON.

3 Select a Wi-Fi network

- When you select a Wi-Fi network protected by security, enter a password (security key) and tap [CONNECT].
- After selecting Wi-Fi network, connection selection screen may appear.

✓INFORMATION

- Even when Wi-Fi is ON, packet communication is available. However, while you connect Wi-Fi network, Wi-Fi comes first. When the Wi-Fi network is disconnected, network connection switches to LTE/3G/GPRS automatically. Note that packet communication fee may apply if network connection stays switched.
- If the docomo service is being used via Wi-Fi, "d ACCOUNT" needs to be set. To make settings, from the Home screen, tap  → [Settings] → [docomo service/cloud] → [d ACCOUNT setting] to operate.
- If more than one Wi-Fi network has been saved, you can switch from one network to another by selecting the destination network and then tapping [CONNECT]. The Wi-Fi network you are currently connected to is disconnected and the network automatically switches to the selected Wi-Fi network.
 - * Even after you are disconnected from the network, its information will remain on the terminal. You can reconnect to the network by performing the connecting operation.

◆ Scanning Wi-Fi network

- Set Wi-Fi to ON in advance.

1 From the Home screen,  → [Settings] → [Wireless & networks] → [Wi-Fi]

2 [MENU] → [Refresh]

◆ Adding Wi-Fi network

Enter network SSID or security information to add Wi-Fi network manually.

- Set Wi-Fi to ON in advance.

1 From the Home screen,  → [Settings] → [Wireless & networks] → [Wi-Fi]

2 [Add network]

3 Enter a network SSID of Wi-Fi network to add → Select security

- Security can be set to [None], [WEP], [WPA/WPA2 PSK] or [802.1x EAP].

4 Enter additional security information as required → [SAVE]

◆ Deleting Wi-Fi network connecting information

1 From the Home screen,  → [Settings] → [Wireless & networks] → [Wi-Fi]

2 Select the connected Wi-Fi network → [FORGET]

◆ Wi-Fi Easy Settings

You can connect through simple operations when connecting via a Wireless access point supporting AOSS™ and WPS connection.

- Set Wi-Fi to ON in advance.

1 From the Home screen,  → [Settings] → [Wireless & networks] → [Wi-Fi]

2 [MENU] → [Advanced] → [Easy Settings]

3 Select a registration method

AOSS™ system : [AOSS system] → Tap [AOSS] button →

Perform operations on the access point → On the connection complete screen, [Finish]

WPS system : [WPS system] → [Push button system]/[PIN entry system (8 digits)]/[PIN entry system (4 digits)] →

Perform necessary operations on the access point

- In case of push button method, press a dedicated button on an access point. In case of PIN entry method, enter PIN code displayed on the terminal to an access point device.

✓ INFORMATION

- For some wireless LAN access points, AOSS™ connection may not be established. If connection is failed, use WPS connection or connect manually.
- When security on the wireless LAN access point is set to WEP, you cannot connect in WPS system.

◆ Connecting other devices with Wi-Fi Direct

Connect between Wi-Fi Direct devices without routing an access point etc.

- Set Wi-Fi to ON in advance.
- To transfer data such as videos or still images using Wi-Fi Direct, obtain an application compatible with data transfer via Wi-Fi Direct from Play Store and install it.

1 From the Home screen,  → [Settings] → [Wireless & networks] → [Wi-Fi]

2 [MENU] → [Advanced] → [Wi-Fi Direct]

- When a Wi-Fi Direct device does not appear, tap [SEARCH FOR DEVICES].

3 Tap a detected Wi-Fi Direct device

Disconnecting Wi-Fi Direct device : Tap a connected Wi-Fi Direct device → [OK]

■ When other Wi-Fi Direct device requests connecting to the terminal

When an invitation screen for connecting appears, tap [ACCEPT].

◆ Multi-connection

Set whether to use Wi-Fi network and packet communication (LTE/3G) simultaneously for the comfortable Internet connection. When Multi-connection is set to ON, you can download or stream various contents such as videos and music with high-speed communication (High-speed download/High-speed streaming).

- Connect to Wi-Fi network with Wi-Fi ON in advance. → P123
- A packet communication charge may be applied using Multi-connection since it also uses packet communication (LTE/3G). If you do not want to use packet communication, turn off Multi-connection.
- Multi-connection may not be available depending on the application.
- Depending on the connected Wi-Fi network, high-speed communication may not be available.

1 From the Home screen,  → [Settings] → [Wireless & networks] → [Wi-Fi]

2 [MENU] → [Advanced] → [Multi-connection]

3 Set [Multi-connection] to ON

4 Set required items

- Tap [Select mode] to select communication mode for Multi-connection.
- Register a Wi-Fi network in [Frequently used hotspot], and the terminal will preferentially use Wi-Fi when you are connected to the registered Wi-Fi network.

◆ About applications compatible with Multi-connection

The application displayed by tapping [Select application] is the Multi-connection target.

✓ INFORMATION

- When the running application is selected in [Select application], enabling the setting may take time. To enable the setting immediately, end the running application and restart the terminal.
- Some functions may be restricted when using Wi-Fi for the site that distinguished network connection (dメニュー (dmenu)→Items in "My docomo (お客様サポート)" (My docomo (customer support)) etc.). In that case, turn off Wi-Fi before use. On the website that does not support multi-connection, you cannot see some part of a streaming movie. In that case, turn off Multi-connection before use.
- Multi-connection cannot be used in the following cases.
 - In Airplane mode
 - During international roaming
 - Tethering in use
 - VPN in connection
 - Wi-Fi Direct/Miracast in connection
- If the Wi-Fi network registered in [Frequently used hotspot] behaves erratically, some applications that usually restrict communications to Wi-Fi may temporarily switch over to packet communications (LTE/3G).
- When Multi-connection is set to OFF, high-speed download/high-speed streaming also turns OFF.
- If data amount exceeds the limit of subscribed budget plan and transmission speed is limited, multi-connection does not work.

◆ Wi-Fi Auto ON/OFF

Turn Wi-Fi to ON/OFF automatically using information from the mobile network base station.

Set whether to turn on the Wi-Fi function when the Wi-Fi network which has been connected is automatically detected, or turn off the Wi-Fi function when the Wi-Fi network which has not ever been connected is automatically detected.

1 From the Home screen, →[Settings]→[Wireless & networks]→[Wi-Fi]

2 [MENU]→[Advanced]→Mark/Unmark [Wi-Fi Auto ON/OFF]

✓ INFORMATION

- The area where this function is set to ON and the terminal is connected consecutively to the same access point for 2 minutes or more is detected as the connected Wi-Fi network.
- This function does not work if Airplane mode or Wi-Fi tethering is ON.
- The terminal may not connect automatically with this function if Wi-Fi information in the area is changed etc. In such case, connect manually.

◆ Wi-Fi sleep policy

Set whether to disconnect Wi-Fi when the screen of the terminal turns off or while charging.

- 1 From the Home screen,  → [Settings] → [Wireless & networks] → [Wi-Fi]
- 2 [CONFIGURE] → [Wi-Fi sleep policy] → Select the item

◆ Advanced Wi-Fi settings

- 1 From the Home screen,  → [Settings] → [Wireless & networks] → [Wi-Fi]
- 2 [MENU] → [Advanced]
- 3 Set each item
 - Install certificates** : Install certificates.
 - Wi-Fi Direct** : Setting steps → P125
 - Easy Settings** : Setting steps → P124
 - Multi-connection** : Setting steps → P125
 - Wi-Fi Auto ON/OFF** : Setting steps → P126
 - Wi-Fi optimization** : Set whether to minimize battery usage when Wi-Fi is ON.

◆ Configuring Wi-Fi

- 1 From the Home screen,  → [Settings] → [Wireless & networks] → [Wi-Fi] → [CONFIGURE]

2 Set the items

- Saved network** : Display the saved Wi-Fi networks.
- Network notification** : Set whether to notify when a Wi-Fi open network is available.
- Wi-Fi sleep policy** : Setting steps → P127
- MAC address** : Display the MAC address.
- IP address** : Display the IP address.

Data usage

Check the data usage amount or make settings for the cellular data communication.

- 1 From the Home screen,  → [Settings] → [Data usage]
- 2 Set the items
 - Usage** : Display the cellular data usage for the period specified in "Billing cycle".
 - Data saver** : Restrict the background data communication of applications. To set applications not to restrict the data communication, tap [Unrestricted data access].
 - Cellular data** : Setting steps → P128
 - Cellular data usage** : Display the cellular data usage for the period specified in "Billing cycle" in a graph. Also, cellular data usage amount per application can be checked.
 - Billing cycle** : Setting steps → P128
 - Wi-Fi data usage** : Display the Wi-Fi data usage in a graph. Also, Wi-Fi data usage amount per application can be checked.
 - Network restrictions** : Set to restrict usage of the specified Wi-Fi network.

◆ Cellular data

Enable the Internet access via cellular network.

- 1 From the Home screen,  → [Settings] → [Data usage] → Turn [Cellular data] to ON

◆ Setting a billing cycle

Set a billing cycle (measuring period), a data amount for warning, or an upper limit of data usage.

- 1 From the Home screen,  → [Settings] → [Data usage] → [Billing cycle]

2 Set required items

✓INFORMATION -----

- The displayed data amount is an estimation. To check the actual data usage amount, refer to "My docomo".
- If the data usage reaches to the specified upper limit, the notification screen indicating that the cellular data communication is paused appears. To resume the cellular data communication, tap [RESUME].

Airplane mode

When Airplane mode is set, wireless functions of the terminal (phone, packet communication, Wi-Fi, Miracast, tethering, Bluetooth function) are disabled. Wi-Fi, Miracast and Bluetooth function can be manually turned on in Airplane mode.

- 1 From the Home screen,  → [Settings] → [Wireless & networks] → [More]

2 Set [Airplane mode] to ON

✓INFORMATION -----

- You can also enable/disable Airplane mode from the phone options menu displayed by pressing and holding .

Tethering

Tethering is a function for using mobile devices such as smartphones as modems to allow external devices connected via USB cable, Wi-Fi or Bluetooth communications to access the Internet.

- While tethering is enabled, for using sp-mode function other than Internet connection and mail service, authentication may not be available or sign in by d ACCOUNT may be required. When authentication is not available, disable tethering to use.
- When you connect to Internet using tethering, Wi-Fi device applications such as web browser or game may not work properly depending on the condition of use.

◆ USB tethering

Connect the terminal to a PC using USB cable A to B 01 (optional) to use the terminal as a modem to access the Internet.

- 1** Connect the terminal and a PC with the USB cable
- 2** Open the Notification panel → Tap the notification of USB option
- 3** [USB tethering] → Turn [USB tethering] to ON

✓ INFORMATION

- Operations for Windows7, Windows 8.1, and Windows 10 PCs are confirmed. Note that DOCOMO does not guarantee the operations of every PC.

◆ Wi-Fi tethering

You can allow Wi-Fi devices to access the Internet by using the terminal as Wi-Fi hotspot.

- You can connect up to 10 Wi-Fi devices.
- Only 2.4 GHz is supported for tethering.

1 From the Home screen,  → [Settings] → [Wireless & networks] → [More] → [Tethering]

2 Set [Wi-Fi tethering] to ON

- If the Wi-Fi hotspot screen is displayed, change the settings as needed and tap [SAVE]. → P129

◆ Setting Wi-Fi tethering

Change the settings as needed.

- By default, [F-05J_AP] is set for Network name, [WPA2 PSK AES] is set for Security, and a random value is set for [Password].

1 From the Home screen,  → [Settings] → [Wireless & networks] → [More] → [Tethering] → [Wi-Fi access point]

2 Enter a network SSID → Select an option for Security → Enter the password → [SAVE]

- Security can be set to [Open], [WEP64], [WEP128], [WPA2 PSK AES], or [WPA/WPA2 PSK].

◆ Easy settings for Wi-Fi tethering

Register Wi-Fi device supporting WPS.

- Set Wi-Fi tethering to ON in advance.

1 From the Home screen,  → [Settings] → [Wireless & networks] → [More] → [Tethering] → [Easy settings for Wi-Fi tethering]

2 [Push button system]/[PIN entry system] → Set required items → On the registered screen, [OK]

- In case of push button method, press a dedicated button on the Wi-Fi devices. In case of PIN entry method, enter PIN code displayed on the Wi-Fi device and tap [OK].

◆ Bluetooth tethering

You can connect your Bluetooth devices to the Internet.

- Up to 4 Bluetooth devices can be connected simultaneously.
- You need to pair the Bluetooth devices with your terminal beforehand. → P165

1 From the Home screen,  → [Settings] → [Wireless & networks] → [More] → [Tethering]

2 Set [Bluetooth tethering] to ON

✓INFORMATION

- The terminal supports dial-up connection using the DUN profile. → P165
For settings of the Bluetooth device, refer to the operation manual of the Bluetooth device.

VPN (Virtual Private Network)

VPN (Virtual Private Network) is a technology to connect to the information in a protected local network such as enterprises or universities from another network. To set up a VPN connection from the terminal, you need to retrieve the information related to security from your network administrator.

- Authentication may be required. Set pattern, security code, or password for the security unlock preference in advance. → P145

◆ Adding VPN

1 From the Home screen,  → [Settings] → [Wireless & networks] → [More] → [VPN]

2 [+] → Set each item → [SAVE]

◆ Connecting to VPN

1 From the Home screen,  → [Settings] → [Wireless & networks] → [More] → [VPN]

2 Select a VPN to connect to

3 Enter necessary authentication information → [CONNECT]

- When you are connected to the VPN,  appears on the status bar.

◆ Disconnecting VPN

- 1 From the Home screen, **[]**→[Settings]→[Wireless & networks]→[More]→[VPN]
- 2 Select a VPN to disconnect
- 3 [DISCONNECT]

Cellular networks

Disable data communication or add an access point.

◆ Stopping the packet communication

Some applications automatically perform packet communications. Packet communication is kept active unless you cut off the connection or the time-out occurs. Activate or deactivate packet communication as required.

- 1 From the Home screen, **[]**→[Settings]→[Wireless & networks]→[More]→[Cellular networks]
- 2 Turn [Data enabled] to OFF
- 3 Check the content and [OK]

◆ Setting access point (APN)

Access point for connecting to the Internet (sp-mode) is already registered. You can add and change access points if necessary.

For details on sp-mode, refer to NTT DOCOMO website.
<https://www.nttdocomo.co.jp/service/spmode/> (In Japanese only)

For using mopera U, Business mopera Internet, add the access point manually.

For details on mopera U, refer to mopera U website.
<https://www.mopera.net/> (In Japanese only)

- When Tethering is set to on, access point setting is unavailable. →P129

◆ Checking the access point in use

- 1 From the Home screen, **[]**→[Settings]→[Wireless & networks]→[More]→[Cellular networks]→[Access Point Names]

◆ Adding an access point

- Do not change the MCC/MNC to other than 440/10. The setting disappears from the screen.

- 1 From the Home screen, **[]**→[Settings]→[Wireless & networks]→[More]→[Cellular networks]→[Access Point Names]
- 2 [+]
- 3 [Name]→Enter a network profile→[OK]

- 4 [APN]→Enter the access point name→[OK]
- 5 Enter other items required by network operator→[MENU]→[Save]

✓INFORMATION -----

- If you have changed MCC/MNC settings and they do not appear on the screen, reset to default or set the access point manually.

❖ Initializing an access point

By initializing an access point, the default state is restored.

- 1 From the Home screen, →[Settings]→[Wireless & networks]→[More]→[Cellular networks]→[Access Point Names]
- 2 [MENU]→[Reset to default]

✓INFORMATION -----

- You can delete access point one by one by tapping an access point from the APN list screen→Tap [MENU] on the access point editing screen→and [Delete APN].

Network settings reset

Reset the network settings.

- 1 From the Home screen, →[Settings]→[Wireless & networks]→[More]→[Network settings reset]
- 2 [RESET SETTINGS]→[RESET SETTINGS]
 - When you set security unlock preference requiring authentication, authentication is needed.

Display & Wallpaper

Set screen brightness or auto-rotate screen.

1 From the Home screen,  → [Settings] → [Display/Sound/Apps] → [Display & Wallpaper]

2 Set required items

Brightness level : Setting steps → P133

Auto-rotate screen : Set whether to rotate screen according to the terminal orientation.

- Even when you change the orientation of the terminal, the screen may not change depending on the screen displayed.

Wallpaper : Setting steps → P59

Screen timeout : Setting steps → P134

Screen saver : Setting steps → P134

Font size : Change the font size.

Display size : Enlarge/reduce the size of the displayed icons etc.

Screen/Music Cast : Setting steps → P171

Homescreen selector : Setting steps → P57

Customize screen : Setting steps → P56

Blue light cut mode : Set whether to cut down blue light emitted from the screen.

Video correction : Set whether to correct image quality of videos (1Seg, YouTube, etc.).

- The image quality of videos recorded by the camera or downloaded and saved to microSD card is corrected at the time of playback.
- Video correction may not be available depending on the video.

Picture correction : Set whether to correct the image quality of still images.

Shake to unrotate : Setting steps → P134

Intelligent color adjust : Set whether to adjust screen color tone depending on surrounding light such as a fluorescent lamp, incandescent lamp and sun light.

Best view adjust : Set whether to adjust screen color shade matching the visibility for your age.

- Set your age in [My physical profile] of [Users] → P141

◆ Brightness

Set brightness of screen backlight.

1 From the Home screen,  → [Settings] → [Display/Sound/Apps] → [Display & Wallpaper] → [Brightness level]

2 Slide the slider to adjust brightness → [OK]

- To adjust brightness automatically according to the environment, mark [Automatic brightness] and slide the slider to adjust brightness.
- To make the screen more visible even in a bright place such as outdoors, mark [Super clear mode].

◆ Screen timeout

❖ Sleep

Set time until the screen turns off.

1 From the Home screen,  → [Settings] → [Display/Sound/Apps] → [Display & Wallpaper] → [Screen timeout]

2 [Sleep] → Select time

❖ Keep lit when held

Set whether to keep the screen backlight on while the terminal is in motion, held in hand.

1 From the Home screen,  → [Settings] → [Display/Sound/Apps] → [Display & Wallpaper] → [Screen timeout]

2 Mark/Unmark [Keep lit when held]

◆ Screen saver

Set screen saver which is displayed when the terminal goes into the sleep mode while charging.

1 From the Home screen,  → [Settings] → [Display/Sound/Apps] → [Display & Wallpaper] → [Screen saver]

2 Tap the button in the upper right of the screen to set [Screen saver] to ON

3 Select an application →  → Set each item

- Tap [MENU] → [Start now] to activate Daydream.

◆ Shake to unrotate

By shaking the terminal twice, you can put the screen back to the direction before it rotates automatically by changing your position holding the terminal.



- Set [Auto-rotate screen] of [Display & Wallpaper] to [ON] in advance. → P133

1 From the Home screen,  → [Settings] → [Display/Sound/Apps] → [Display & Wallpaper]

2 Mark [Shake to unrotate]

3 Shake the terminal twice immediately after the screen direction is changed

The orientation of the screen is restored,  appears on the status bar.

- When  is displayed, the screen orientation is locked. When you rotate your terminal to the original orientation,  disappears in about 3 seconds and the orientation lock is canceled.

✓ INFORMATION -----

- The screen view may not be changed depending on the strength, speed or angle of shaking the terminal.

Notifications

Set the display method of notification of each application or function. Also, you can change the settings of the notification LED operations or notifications on the lock screen.

◆ Setting the notifications

1 From the Home screen, → [Settings] → [Display/Sound/Apps] → [Notifications]

- To display all applications, tap [MENU] → [Show system].
- Tap [All apps] in the upper part of the screen to select the condition of displaying applications.

2 Select an application or function → Set each item

Block all : Set whether to block all the notifications.

Show silently : Set whether to notify without sound, vibration, screen display.

On the lock screen : Set whether to display the notification content on the lock screen.

- It is displayed when you set security unlock preference requiring authentication.

Override Do Not Disturb : Set whether to display the notifications when [Do not disturb] is set to [Priority only].

- You can set Do Not Disturb in the panel switch (→P53).
To use the function, display the panel switch →  →
Touch and hold [Do not disturb] and drag to add to the panel switch.

✓INFORMATION

- Available items vary depending on settings of the terminal or application/function.

◆ Advanced settings of Notifications

1 From the Home screen, → [Settings] → [Display/Sound/Apps] → [Notifications] → [ADVANCED]

2 Set each item

On the lock screen : Set whether to all notifications on the lock screen.

Notification LED : Set whether to notify a new SMS or missed call with blinking of the notification LED.

Missed call LED : Set the color of the notification LED for missed call or phone memo.

- It cannot be set if [Notification LED] is unmarked.

Sound

Make settings for volumes, ringtone, etc.

1 From the Home screen,  → [Settings] → [Display/Sound/Apps] → [Sound]

2 Set required items

Media volume : Setting steps → P136

Alarm volume : Setting steps → P136

Ring volume : Setting steps → P136

Manner mode : Setting steps → P137

Turn off sound when flipped : Set whether flipping the terminal stops temporarily ringtone, alarm sound, etc. However, the sound may not stop depending on the applications.

- When vibration is set, vibration also stops temporarily.

Vibrate on ring : Set whether to vibrate while ringtone is sounding.

- You cannot set during manner mode.
- Even if Vibrate on ring is unmarked, vibrator works when Ring volume is set to 0.

Sound at start charging : Set whether to notify by sound when starting charging.

Do not disturb : Set the notification type when [Do not disturb] is set to [Priority only]. Also, set a rule to activate the Do not disturb function automatically, or set not to notify with the screen display, blinking of the notification LED or the screen backlight when [Do not disturb] is set to [Total silence].

- It cannot be set in Manner mode.

- You can set Do Not Disturb in the panel switch (→P53). To use the function, display the panel switch →  → Touch and hold [Do not disturb] and drag to add to the panel switch.

Phone ringtone : Set phone ringtone.

- When ringtone is set for contacts, ringtone for contacts is given priority.

Default notification ringtone : Set the notification sound.

Default alarm ringtone : Set the alarm sound.

Other sounds : Set Dial pad tones, Screen locking sounds, Touch sounds, or Vibrate on tap.

- Screen locking sounds are available when the security lock preference is set to other than [None]. → P145
- When Vibrate on tap is set, the terminal vibrates when tapping the icon on the navigation bar/dialing with "Phone" application/authenticating with the security unlock preference set to Pattern or Security code.

Screen/Music Cast : Setting steps → P171

◆ Volumes

You can adjust volume of media playing sound, alarm sound, ringtone.

- You cannot set while Manner mode is enabled.

1 From the Home screen,  → [Settings] → [Display/Sound/Apps] → [Sound] → [Media volume]/[Alarm volume]/[Ring volume]

2 Slide the slider to adjust sound volume

✓ INFORMATION

- When [Ring volume] is set to 0, the vibration turns to ON. To set the vibration OFF, set it to the Manner mode (Silent) (→ P137).

◆ Manner mode

Set/Cancel Manner mode.

- You can change the Manner mode type. → P137

1 From the Home screen,  → [Settings] → [Display/Sound/Apps] → [Sound] → [Manner mode]

2 Set [Manner mode] to ON

- When Manner mode is set, the status icon appears on the status bar. The icon varies by Manner mode type. For each icon, see "Icons on the status bar". → P51

✓ INFORMATION

- You can also enable/disable Manner mode in the followings.
 - Press the volume down key for 1 second or more
 - Open the Notification panel → In the Panel switch, [Manner]
 - Press and hold  until the phone options menu appears → [Manner mode]
 - * Depending on the manner mode you set, tap [Manner mode (Silent)]/[Manner mode (Alarm)]/[Original manner].
- Regardless of Manner mode settings, shutter sound, shooting start/end sound, auto focus lock sound, count down sound for self timer, screen shot sound while the camera is activated, capturing sound for Capture & Draw/Highlight & Copy, and Find Me Ringtone for Bluetooth Low Energy Settings are emitted.

❖ Changing Manner mode type

1 From the Home screen,  → [Settings] → [Display/Sound/Apps] → [Sound] → [Manner mode] → [Select manner mode]

2 Selecting an item

Manner mode : All sounds do not sound from the terminal speaker. And the vibration turns to ON.

Manner mode (Silent) : In addition to mute sounds, turn off the vibration.

Manner mode (Alarm) : Same operation as Manner mode except alarm volume and vibration go along to the alarm settings.

Original manner : Set sound volume for each sound type and vibration for incoming calls.

- Note that when the volume of original manner is set [Silent], increasing volume by pressing the volume key up etc. changes the volume settings of original manner.

❖ Original manner

1 From the Home screen,  → [Settings] → [Display/Sound/Apps] → [Sound] → [Manner mode] → [Original manner settings]

2 [Call ringtone volume]/[Media volume]/[Alarm volume]/[Notification volume]

3 Slide the slider to adjust sound volume → [OK]

4 Mark/Unmark [Vibration]

Apps

Manage or delete installed applications.

◆ Viewing permitted operation of the applications in the terminal

- 1 From the Home screen,  → [Settings] → [Display/Sound/Apps] → [Apps]
- 2 Select an application

◆ Clearing app data or cache

- 1 From the Home screen,  → [Settings] → [Display/Sound/Apps] → [Apps]
- 2 Select the application → [Storage] → [CLEAR DATA]/[CLEAR CACHE]
 - When [CLEAR DATA] is selected, tap [OK].

◆ Deleting an application

- For deleting the applications you obtained from Play Store, operating from the Google Play screen is recommended. → P93
- You cannot uninstall some pre-installed applications by default. And if pre-installed applications are uninstalled, you can reset the terminal to restore.

- 1 From the Home screen,  → [Settings] → [Display/Sound/Apps] → [Apps]
- 2 Select an application → [UNINSTALL] → [OK]

◆ Disabling an application

- Disabling application is available for some applications and services that cannot be uninstalled. Disabled applications are not displayed on the applications list screen or the Home screen, or cannot be launched either. But they are not uninstalled.

- 1 From the Home screen,  → [Settings] → [Display/Sound/Apps] → [Apps]
- 2 Select an application → [DISABLE]/[ENABLE]
 - When [DISABLE] is selected, tap [DISABLE].

✓INFORMATION

- When you disable an application, some other applications linked to the disabled application may not be operated correctly. In such case, enable the application again to operate them correctly.

Storage

Check the usage status of the internal storage or microSD card. You can also set a password to a microSD card.

1 From the Home screen,  → [Settings] → [Display/Sound/Apps] → [Storage]

2 Set required items

Internal shared storage : Check total amount of memory of the terminal, amount per data and available amount.

SD card : Check the usage status of microSD card. Tap  to unmount the microSD card (release recognition) to take out safely. To recognize a microSD card, [SD card] → [MOUNT].

SD card password settings : Setting steps → P148

◆ Erasing data in microSD card (Format)

- Note that this operation erases all data in the microSD card.

1 From the Home screen,  → [Settings] → [Display/Sound/Apps] → [Storage] → [SD card]

2 [MENU] → [Storage settings] → [Format]

3 [ERASE & FORMAT] → [DONE]

Battery

Check the remaining amount of battery, etc.

1 From the Home screen,  → [Settings] → [Battery]

2 Set required items

Battery saver : Setting steps → P139

App running time : Display cumulative running time of each application for up to 4 weeks.

App battery check : Display applications which affect the battery life such as applications running in the background when the screen is off.

(Battery usage status) : Display the battery level, remaining available time, applications and functions which consume battery power from the last full charging.

◆ Battery saver

Enable/disable battery saver.

- When the battery saver is enabled, the status bar and navigation bar turn to orange,  is displayed on the status bar.

1 From the Home screen,  → [Settings] → [Battery] → [Battery saver]

2 Tap the button in the upper right of the screen to set [Battery saver] to ON

- Tap [Turn on automatically] → [Never]/[at 5% battery]/[at 15% battery] to set the remaining amount of battery to enable the battery saver automatically.

✓INFORMATION

- When charging starts, the setting of Battery saver turns off automatically. To use Battery saver, turn it on again after charging.

◆ Battery optimization

To suppress battery consumption for each application, the application is disabled when the terminal is not used or the application is not used for several days.

- 1 From the Home screen,  → [Settings] → [Battery]
- 2 [MENU] → [Battery optimization]
- 3 [Not optimized] → [All apps]
- 4 Select an app to change the setting → [Optimize]/[Don't optimize] → [DONE]



Memory

You can check the memory usage conditions of applications installed in the terminal.

- 1 From the Home screen,  → [Settings] → [Display/Sound/Apps] → [Memory]
 - By tapping [Memory used by apps], you can check the memory usage conditions of each application.

Users

Add a user to share the terminal with multiple users (the function with which users and a guest can use the terminal). Switch users or add a guest in the Panel switch (→P53). The information that is necessary for emergency or your profile information can be registered, too.

- 1 From the Home screen,  → [Settings] → [Users]
- 2 Set required items
 - You (XXX)** : The current user. Tap to edit the user names and icons.
 - (User name) : Registered user names are displayed.
 - Set whether to permit a user to use the phone/SMS function and delete a user by tapping  of the user while the owner is using.
 - Guest** : When a guest uses the terminal, "Remove guest" is displayed and you can remove the applications or data that the guest used.
 - Tap  of the guest to set whether to allow the guest to use the phone.
 - + **Add user** : Add an additional user.
 - The initial settings are required every time a user is added. Set according to the instruction on the screen.
 - Add users** : Set whether to add a guest or users from the notification panel on the lock screen when the security unlock preference that requiring authentication is set.
 - Emergency information** : Register your blood type or other information which is useful for initial response when emergency, or emergency contact.
 - My Profile** : Setting steps → P79

My physical profile : Set basic information to use for health care applications or widgets.

✓INFORMATION

- Up to 5 users for the owner and guests in total can be registered.
- To remove a user when the user uses the terminal, from the Home screen, **[Settings]**→**[Users]**→**[MENU]**→**[Delete (user name) from this device]**→Tap **[DELETE]**
- While a user or a guest is using, the displayed functions are different or the use of the applications or functions are limited.
- When a guest is using the terminal, note that recent calls and SMS set to privacy mode (→P149) can be seen from the guest.

Gestures

Set to allow the terminal to be operated by gestures.

1 From the Home screen, **[Settings]**→**[Display/Sound/Apps]**→**[Gestures]**

2 Set each item

Jump to Camera : Set to activate Camera by pressing the power key twice. When it is set to ON, you can activate Camera from every screen.

Turn off sound when flipped : Set whether to stop the ringtone or alarm sound temporarily by turning off the terminal. The sound may not turn off depending on application.

- When the vibrator is set, vibration turns off temporarily, too.

Shake to unrotate : Setting steps→P134

docomo service/cloud

Set docomo service/cloud.

1 From the Home screen,  → [Settings] → [docomo service/cloud]

2 Set required items

d ACCOUNT setting : Set up d ACCOUNT used for docomo applications.

docomo cloud : Make settings compatible with docomo cloud.

docomo apps management : Configure settings such as updates for applications provided by DOCOMO, or actions and notification methods for periodic updates.

Osusume hint : Set to use the recommended usage hint according to the operation or use condition.

AUTO-GPS : Set AUTO-GPS functions etc.

docomo location information : Set location information functions for imadoco search, imadoco kantan search and Keitai-Osagashi Service.

Send device error information : Set for sending error information to the server managed by docomo.

Profile setting : Profile data used for docomo services can be checked/changed.

docomo service initial settings : Set docomo service settings all at once.

Switch USB debugging : Configure settings to use a dedicated terminal at a sales outlet such as a docomo Shop.

Open source licenses : Show open source licenses.

✓INFORMATION

- Some applications displayed in the docomo service/cloud can be disabled. If an application is disabled, it may not appear in the list of docomo service/cloud. If an application is newly downloaded from docomo, an item may be added to the list of docomo service/cloud.

Security

Set up about lock.

1 From the Home screen,  → [Settings] → [Security]

2 Set required items

Security unlock preference : Setting steps → P145

Smart Lock : Setting steps → P146

Password manager : Setting steps → P147

Make passwords visible : Set whether to display passwords when entering security code/passwords.

Information security : Set followings.

Storage type : Setting steps → P147

Trusted credentials : Setting steps → P147

User credentials : Manage the user credentials saved to the terminal.

Install from storage : Setting steps → P147

Clear credentials : Setting steps → P148

SD card password settings : Setting steps → P148

Application lock : Setting steps → P148

Privacy mode settings : Setting steps → P149

Hide recently used app : Setting steps → P151

Device administrators : Set whether to enable the device administration function.

Unknown sources : Setting steps → P151

Set up SIM card lock* : Setting steps → P152

Trust agents : Manage trust agents such as Smart Lock.

Application pinning : Setting steps → P152

Apps with usage access : Manage the application that can access to the application usage history on the terminal.

Encryption settings : Setting steps → P153

* Not displayed if a docomo nano UIM card is not inserted.

◆ Security codes for the terminal

Some functions provided for convenient use of the terminal require the security code to use them. Besides the security code for locking the terminal, the network security code necessary for the network services etc. are available. Make use of the terminal using an appropriate security code according to your purpose.

The security codes/passwords that are necessary for the account to use the network services available with the terminal are as follows.

- Network security code → P144

- d ACCOUNT password

It is a password of d ACCOUNT (→ P142). It is the network security code or an alphanumeric password that you set.

- Google account password

It is a password of Google account (→ P154). It is an alphanumeric password that you set when registering the account.

Notes on the security codes

- To set a security code, avoid imaginable numbers such as "birth date", "a part of phone number", "street address or room number", "1111" or "1234". Maintain a separate record not to forget the numbers.
- Be careful never to reveal your security code to others. If a security code is misused by others, DOCOMO assumes no responsibility for damages resulted from it.
- If you forget your security codes, you need to bring a document (a driver's license etc.) to identify your subscription, the terminal and the docomo nano UIM card to a docomo Shop. For details, contact "General Inquiries" on the last page of this manual.
- The PUK code is written on a subscription form (copy for user) handed at subscription in a docomo Shop. For users subscribed in other than docomo Shop, bring a document (a driver's license etc.) to identify your subscription and the docomo nano UIM card to a docomo Shop, or contact "General Inquiries" on the last page of this manual.

❖ Network security code

The network security code is a 4-digit number necessary for identification or using the docomo Network Services at reception of your request in docomo Shop or at a docomo Shop, docomo Information Center or "お客様サポート (Customer support)". It can be set any number at the subscription and also changed later by yourself.

- For details of network security code, refer to NTT DOCOMO website.
<https://www.nttdocomo.co.jp/english/support/trouble/password/network/>

❖ PIN code

You can set up a security code called a PIN code for your docomo nano UIM card. At the time of subscription, the code is set to "0000", which you can change by yourself. →P152
PIN is a 4- to 8-digit number (code) that must be entered each time you insert the docomo nano UIM card into the terminal or when the terminal is powered ON for user confirmation to prevent unauthorized use of the docomo nano UIM card by a third party. Entering the PIN code enables making/receiving calls and terminal operation.

- For using the docomo nano UIM card that you have used on another terminal by inserting to this terminal, use the set PIN code on the former terminal. If you did not change the setting, the code is "0000".
- If you enter a wrong PIN code 3 times consecutively, the PIN code is locked (PUK lock) and cannot be used anymore. In this case, unlock with "PUK". Unlock the PIN code before setting new PIN code.

- When docomo nano UIM card is locked by PIN or PUK, remove the docomo nano UIM card. The Home screen will appear and you can perform communication using Wi-Fi function.

❖ PUK code

The PUK code is an 8-digit number for canceling the locked PIN code. The PUK code cannot be changed by yourself.

- If you enter a wrong PUK code 10 times consecutively, the docomo nano UIM card is locked. Please contact a docomo Shop.
- When docomo nano UIM card is locked by PIN or PUK, remove the docomo nano UIM card. The Home screen will appear and you can perform communication using Wi-Fi function.

❖ microSD password

You can set a password to a microSD card. If you use the microSD card with password set by inserting to another phone, password authentication on the phone is required. If you insert it to a PC or phone without password setting function, use of data or formatting cannot be made.

- Some microSD cards may not support this function.

◆ Setting Security unlock preference

Set type of authentication operation to cancel the screen lock.

1 From the Home screen,  → [Settings] → [Security] → [Security unlock preference]

2 Authenticate

- To set for the first time, authentication is not required.

3 Selecting an item

None : Set not to display the lock screen.

Touch/Swipe : Set to unlock by touch/swipe.

Pattern : Set to unlock by a pattern connecting at least 4 points.

Security code : Set to unlock by a security code (4- to 16-digit number).

Password : Set to unlock by a password (which consists of 4 to 16 alphanumeric/symbols).

4 of [Security unlock preference] as required → Set required items

- The displayed items differs depending on the setting of the security unlock preference.

Make pattern visible : Set whether to display the pattern when entering the unlock pattern.

Automatically lock : Set to activate the screen lock when the specified time is elapsed after the terminal goes into sleep mode when the security unlock preference that requires authentication is set.

Power button instantly locks : Set whether to activate the screen lock instantly by pressing . Canceling the screen lock requires authentication.

Lock screen message : Enter a message to be displayed on the lock screen.

Slide to activate camera : Set whether to activate Camera by flicking from the right end of the lock screen to the left.

✓INFORMATION -----

- While you use authentication storage, pattern, security code, and password are available for the security unlock preference.

❖ Locking screen lock

To activate the screen lock, set the security unlock preference (→P145) and then press  to let the terminal in sleep mode, or when the specified time set in [Automatically lock] is elapsed after the screen backlight turns off automatically.

- To cancel the screen lock, press  to cancel the sleep mode and perform operations for the security unlock preference type.

✓INFORMATION -----

- When the Google account is set, you can set a lock function by the password using a PC or tablet. If the terminal is lost, access to the following URL and log in with the Google account set for the terminal.
<https://www.google.com/android/devicemanager>
 - Enter the new password in the terminal to unlock the screen lock.
 - If you do not sign in to Google account, the operation is unavailable.

❖ When you forget unlocking method

- When the security unlock preference that requires authentication is set and if you fail unlocking screen lock 5 times or more, the cancel operation cannot be performed temporarily. Retry after a certain period of time.
- If you forget the pattern/security code/password of the security unlock preference, contact a docomo shop.

✓INFORMATION -----

- You can make emergency calls from the lock screen without unlocking the screen lock.→P68

◆ Smart Lock

Set the method to unlock the screen lock when connecting from an external device or by face recognition.

- Set a security unlock preference which requires authentication in advance.→P145

1 From the Home screen, →[Settings]→[Security]→[Smart Lock]→Authenticate

2 Set required items

- For details on Smart Lock, refer to Help by tapping →[Help].

◆ Password manager

Register and manage your authentication information such as an ID (account) or password. You can quote the registered contents to enter. → P42

- Set a security unlock preference which requires authentication in advance. → P145
- Up to 100 items can be registered.

1 From the Home screen, **■** → [Settings] → [Security] → [Password manager] → Authenticate

2 [REGISTER] → Set each item → [DONE]

Editing : Tap a title → Edit each item → [DONE]

Deleting : Touch and hold a title → Drag it to  at the bottom of the screen → [OK]

Sorting : Touch and hold a title → Drag it to the destination

Backing up/restoring : [MENU] → [Backup/Restore] → Select an item → Follow the onscreen instructions to operate

Deleting all : [MENU] → [Delete all] → [OK]

◆ Managing authentication information

You can display credential authentication information or certificates or install authentication information for accessing VPNs etc. or other certificates.

❖ Displaying authentication information storage type

1 From the Home screen, **■** → [Settings] → [Security] → [Information security]

2 Check [Storage type]

❖ Displaying trusted credentials or certificates

1 From the Home screen, **■** → [Settings] → [Security] → [Information security] → [Trusted credentials]

✓ INFORMATION

- To delete installed certificates, delete from [Clear credentials].

❖ Installing authentication information or certificate

You can install authentication information or certificates.

1 From the Home screen, **■** → [Settings] → [Security] → [Information security] → [Install from storage]

2 Select the authentication information/certificate you want to install

3 If necessary, enter the password → [OK]

4 Enter the name of the authentication information/certificate→[OK]

❖ Clearing credentials

Clear all authentication information, certificates or VPN settings from the authentication storage.

1 From the Home screen, →[Settings]→[Security]→[Information security]

2 [Clear credentials]→[OK]

◆ SD card password settings

Set a password to microSD card to prevent others from misusing.

- Some microSD cards may not support this function.
- Set a security unlock preference which requires authentication in advance.→P145

1 From the Home screen, →[Settings]→[Security]→[Information security]

2 [SD card password settings]→Authenticate

3 Set required items

- When precautions about unmount SD card appear, confirm the content and tap [OK].

Register password : Register a password for a microSD card (within one-byte 16 digits).

- 1 password per a microSD card and up to 20 passwords can be registered. When number of registrations exceeds the limit, the oldest registration is deleted to register a new one.

Authenticate password : Authenticate by password if a microSD card whose password is set in other than the terminal is attached.

Change password : Change a password of microSD card.

Delete password : Delete a password of microSD card.

Forcibly delete password : Delete all data including a password of microSD card.

- You can perform the operations only if you install a microSD card to which a password is set on another terminal and you have not authenticated password with the terminal yet.

■ When a password is set to microSD card

Password authentication is required when the microSD card is attached to other terminal. If you attach it to a PC or a phone without password setting function, using the data or formatting cannot be made.

◆ Application lock

Set applications that require authentication for activation.

- Set a security unlock preference which requires authentication in advance.→P145

1 From the Home screen, →[Settings]→[Security]→[Information security]

2 [Application lock]→Authenticate→Mark/Unmark applications

3 [MENU]→[Settings]→Mark/Unmark [App lock]

◆ Privacy mode

If Privacy mode is set, you can hide bookmarks for browser, pictures, or applications (when Home application is set to NX!Home). If you download application compatible with Privacy mode, you can hide phonebook entries or mails of specified persons and can set actions for incoming call or mail.

- It is compatible with NX! Contact and NX! Mail. Follow the onscreen instructions shown on the way in operations of "Privacy mode operation settings (Phonebook/History)" (→P149) to download the application and use it.

◆ Precautions when using Privacy mode

- For descriptions, notes or compatible applications for Privacy mode, from the Home screen, →[Settings]→[Security]→[Information security]→[Privacy mode settings]→Authenticate→Tap [Function description/notes] and refer to each item.
- Privacy mode can be set only for phonebook in FUJITSU account. If you change docomo account to FUJITSU account, data added by i-concier, SNS account information are not saved.
- When you set Privacy mode to a phonebook entry registered to Favorites or Group, account is changed automatically and registered information is changed to be hidden in Favorites or Group.
- This function is not compatible with docomo mail.
- When a guest is using the terminal by using functions available by users and guests (→P140), note that recent calls and SMS set to privacy mode can be seen from the guest.

◆ Privacy mode settings

- Set a security unlock preference which requires authentication in advance.→P145

1 From the Home screen, →[Settings]→[Security]→[Information security]→[Privacy mode settings]→Authenticate

- If an explanation screen for Privacy mode is displayed, confirm the content and tap [USE].

2 Set [Privacy mode] to ON

- When notes appears, confirm the content and tap [CLOSE]. If you tap [DISPLAY NOTES], check each item and tap  (Back).

◆ Privacy mode operation settings (Phonebook/History)

Specify a phonebook entry/group to be hidden.

- To make operation settings for Phonebook/History, install NX! Contact. If you did not install yet, follow the onscreen instructions on the way of operation to download.

1 From the Home screen, →[Settings]→[Security]→[Information security]→[Privacy mode settings]→Authenticate

2 [Call/Mail privacy]→Set each item

Phonebook/History : Set whether to hide specified phonebook entry/group in privacy mode.

Phonebook setting : Specify phonebook entry/group to be hidden.

- When "Change account" appear in the phonebook entry list, confirm the content and tap [OK].

✓INFORMATION

- When you specify a group, privacy mode is set to the phonebook entry registered into the group. To cancel privacy mode in case of changing group, etc., cancel privacy mode for phonebook.
- When privacy mode for a group is canceled, privacy mode set for phonebook entry registered into the group is also canceled. In this time, phonebook entry registered into several groups can be viewed even if privacy mode is still set to the other groups. In such case, newly set groups.

❖ Privacy mode operation settings (Action when call received)

Set actions for incoming call or mail.

- Specify phonebook in "Privacy mode operation settings (Phonebook/History)".→P149

1 From the Home screen, →[Settings]→[Security]→[Information security]→[Privacy mode settings]→Authenticate

2 [Call/Mail privacy]→Set each item

Action when call received : Set action for incoming call from specified phonebook entry/group in privacy mode.

Action when mail received : Set action for receiving mail from specified phonebook entry/group in privacy mode.

❖ Privacy mode operation settings (Others privacy)

You can specify to hide icons, bookmarks of Browser or images in Gallery on the application list (when Home application is set to NX!Home).

1 From the Home screen, →[Settings]→[Security]→[Information security]→[Privacy mode settings]→Authenticate

2 [Others privacy]→Set each item

Home/Browser/Picture : Set to hide icons of specified applications on the Home screen or hide specified bookmarks or images during privacy mode.

Home setting/Browser setting/Picture setting : Specify applications, bookmarks or images to be hidden.

Action for app notifications : Set whether to hide notifications from application in privacy mode.

- Even if Notify is set, the notifications from the application whose notifications is blocked in [Notifications] of [Display/Sound/Apps] are not displayed.

Dictionary for predictive text input : Set Super ATOK ULTIAS predictive conversion dictionary used in privacy mode.

Receive indicator : Set whether to notify you of incoming calls/receiving mails from the phonebook/group specified to hide by changing battery icon type in privacy mode.

❖ Auto launch of Privacy mode

Set Auto launch of Privacy mode.

- 1 From the Home screen,  → [Settings] → [Security] → [Information security] → [Privacy mode settings] → Authenticate
- 2 [Activate/Deactivate options] → [Auto launch] → Select the item.
 - When [Launch during sleep] is selected and the screen backlight turns off with Privacy mode canceled, Privacy mode activates after the screen is displayed again.

❖ Activating/Deactivating Privacy mode

- 1 Flick the time display section to the right with the Notification panel opened

◆ Displaying/Hiding recently used applications

Set whether to display recently used applications when you tap  (History).

- 1 From the Home screen,  → [Settings] → [Security] → [Information security]
- 2 Mark/Unmark [Hide recently used app]

◆ Permitting to install unknown sources applications

Permit to install applications obtained from sites other than Play Store, mails, etc.

- To protect the terminal and personal data, download applications only from trusted sources such as Play Store etc.
- 1 From the Home screen,  → [Settings] → [Security] → [Information security]
 - 2 Mark [Unknown sources] → Confirm precautions and [OK]

◆ Setting PIN code

❖ Setting SIM card lock

Set PIN code to be entered when the terminal is turned ON.

1 From the Home screen,  → [Settings] → [Security] → [Information security] → [Set up SIM card lock]

2 [Lock SIM card] → Enter the PIN code → [OK]

✓ INFORMATION

- When entering the PIN code for the first time, enter "0000".
- To cancel the setting, set [Lock SIM card] to OFF in Step 2.

❖ Changing PIN code

Set the PIN code (set [Lock SIM card] to ON) in advance.

1 From the Home screen,  → [Settings] → [Security] → [Information security] → [Set up SIM card lock]

2 [Change SIM PIN]

3 Enter the current PIN code → [OK]

4 Enter a new PIN code → [OK]

5 Enter the new PIN code again → [OK]

❖ Entering PIN code

1 Turn power ON → Enter PIN code on the PIN code entry screen → 

❖ Unlocking PIN lock

If PIN code is locked (PUK lock), unlock PIN and set new PIN code.

1 Enter PUK code in the PIN code entry screen → 

2 Enter a new PIN code → 

3 Enter the new PIN code again → 



◆ Application pinning

Set whether to fix the currently running application to prevent other applications from using.

1 From the Home screen,  → [Settings] → [Security] → [Information security] → [Application pinning]

2 Tap the button in the upper right of the screen to set [Application pinning] to ON

3 Activate the application to be fixed

4  (History) →  of the application to be fixed → [GOT IT]

- To cancel pinning of application, touch and hold  (Back).

✓INFORMATION -----

- You can set to require authentication when unpinning application by setting [Security authentication for unpinning] to ON in Step 2.

◆ Encryption settings

◆ Encrypt phone

Encrypt all data (including settings and applications) in the terminal. After encryption, you may need to enter security code, password, or pattern to decrypt each time you turn the terminal on. To disable encryption, you need to reset the terminal to default.

- Charge the battery fully and perform the operation while charging.

1 From the Home screen,  → [Settings] → [Security] → [Information security] → [Encryption settings]

2 [Encrypt phone] → [ENCRYPT PHONE] → [ENCRYPT PHONE]

- When a security unlock preference which requires authentication is selected, authentication is required.

◆ Encrypt SD card

Encrypt all data in the microSD card installed to the terminal.

- Set [Security code] or [Password] for the security unlock preference in advance. → P145
- Charge the battery fully and perform the operation while charging.

1 From the Home screen,  → [Settings] → [Security] → [Information security] → [Encryption settings]

2 [Encrypt SD card] → [ENCRYPT SD CARD] → Authenticate → [ENCRYPT SD CARD] → [OK]

Disabling encryption : [Unencrypt SD card] → [UNENCRYPT SD CARD] → Authenticate → [UNENCRYPT SD CARD] → [OK]

✓INFORMATION -----

- Data of encrypted SD card will not be able to use with other terminal except this terminal. If data reset is performed, data of encrypted microSD card cannot be used, therefore disable microSD card encryption before resetting the terminal.

Accounts

Add or delete accounts.

◆ Adding accounts

1 From the Home screen, **■**→[Settings]→
[Location/Accounts]→[Accounts]

2 [Add account]→Select account type→Follow
onscreen instructions

Setting account : Select an account type→Set an account
→Set each item

✓INFORMATION -----

- Multiple Google accounts can be added on the terminal.
- Tapping free area other than displayed screen may cancel operation.
- [MENU]→Marking [Auto-sync data] synchronizes the terminal with online service information such as Google.

◆ Removing accounts

1 From the Home screen, **■**→[Settings]→
[Location/Accounts]→[Accounts]

2 Select an account type→Select an account→
[MENU]→[Remove account]→[REMOVE
ACCOUNT]

✓INFORMATION -----

- docomo account and FUJITSU account cannot be removed.

◆ Starting synchronization manually

1 From the Home screen, **■**→[Settings]→
[Location/Accounts]→[Accounts]

2 Select an account type→Select an account→
[MENU]→[Sync now]

■ Canceling sync

1 During synchronization, [MENU]→[Cancel
sync]

Google

Information and settings for Google account and services can be checked/changed/deleted.

- For details about Google settings, on the Google screen, tap  → [Help & feedback] to refer.

1 From the Home screen, → [Settings] → [Google]

The Google setting screen is displayed.

2 Set required items

Languages & input

Change the language used for the terminal, font or character size.

1 From the Home screen, → [Settings] → [Languages & input]

2 Set required items

Languages : Setting steps → P156

Spell checker : Set whether to run the spell checker.

Personal dictionary : Add words for using a spell checker application etc.

Font settings : Setting steps → P156

Font size : Change font size.

Current Keyboard : Setting steps → P44

Virtual keyboard : Setting steps → P44, P156

- Tap [Manage keyboards] to set the keyboard displayed in the keyboard options screen.

Physical keyboard : Set the option when a keyboard is connected to the terminal. → P47

Text-to-speech output : Set up text-to-speech output.

Pointer speed : Set pointer speed when a mouse or trackpad is used.

◆ Switching to English display

Change the language to be used to English.

- 1 From the Home screen, **□**→[設定 (Settings)]→[言語と入力 (Languages & input)]→[言語 (Languages)]
- 2 Drag **≡** of [English (United States)] to the top layer (position of [1])

✓INFORMATION

- Some applications are not displayed in English.
- To change to the Japanese display, operate as follows.
From the Home screen, **□**→[Settings]→[Languages & input]→[Languages]→Drag **≡** of [日本語 (日本) (Japanese (Japan))] to the top layer (position of [1])

◆ Font settings

Change display font type.

- 1 From the Home screen, **□**→[Settings]→[Languages & input]→[Font settings]
- 2 Select a font→[OK]

✓INFORMATION

- Depending on screen, turning the power OFF and ON reflects font settings.
- The font settings may not be reflected or set font may not be displayed correctly on some applications or Web sites.

◆ Setting Voice Search

Setting Google voice search.

- 1 From the Home screen, **□**→[Settings]→[Languages & input]→[Virtual keyboard]→[Google voice typing]
- 2 Set required items
 - Languages** : Set language for Google voice search.
"Ok Google" **detection** : Set up this option so you can start a voice search by saying "Ok Google".
 - Hands-free** : Set whether to permit the request from a hands-free device when the terminal is locked.
 - Speech output** : Set up speech output.
 - Offline speech recognition** : Set up this option so you can use the speech recognition even in offline by downloading another language.
 - Block offensive words** : Set whether to display improper search results.
 - Bluetooth headset** : Set whether to use a Bluetooth device when performing a voice search.

Backup & reset

Back up the data of the terminal or reset the terminal.

1 From the Home screen,  → [Settings] → [Location/Accounts] → [Backup & reset]

2 Set required items

Back up my data : Set whether to back up settings of applications or data to the Google server.

Backup account : Set an account backed up to the Google server.

Automatic restore : Set whether to restore backed up settings or data when reinstalling an application.

Factory data reset : Setting steps → P157

Easy data transfer support : Setting steps → P48

◆ **Resetting the terminal**

All installed applications and saved data to the terminal, for the most part, are deleted when you reset the terminal.

- For disabling encryption of microSD card, refer to "Encrypt SD card". → P153
- To erase microSD card data, see "Erasing data in microSD card (Format)". → P139

1 From the Home screen,  → [Settings] → [Location/Accounts] → [Backup & reset]

2 [Factory data reset] → [RESET PHONE]

- When a security unlock preference which requires authentication is selected, authentication is required.

3 [ERASE EVERYTHING]

A short while after the reset is completed, the terminal will be restarted.

- Do not turn off the terminal while resetting phone.

✓ **INFORMATION** -----

- If the terminal is reset while Privacy mode is set, data saved in the microSD card to which Privacy mode is set cannot be accessed. Make sure to disable Privacy mode with the microSD card attached before resetting. → P149
- If the touch operations cannot be performed correctly after resetting, turn off and on the power.

Useful tools

Set Slide-in function, Pedometer, etc.

1 From the Home screen,  → [Settings] → [Useful tools]

2 Set required items

Voice call : Setting steps → P75

Glove touch : Setting steps → P158

Slide-in function : Setting steps → P158

Slide display : Setting steps → P159

Pedometer : Setting steps → P159

Earphone Launcher : Set the terminal to display a launcher when earphones are connected, so that you can launch applications from there.

- Applications displayed in the launcher can be set in [Launcher setting].

◆ Glove touch

Set whether to improve the sensitivity of the touch panel so you can use touch gestures on the terminal with gloves on.

1 From the Home screen,  → [Settings] → [Useful tools]

2 Mark/Unmark [Glove touch]

✓INFORMATION -----

- Depending on the material of the gloves, you may find touch operation difficult.
- If this is the case, tilt your fingers to bring the pads of the fingers into contact with the touch panel when operating the terminal.
- If [Glove touch] is marked and you use touch gestures without wearing gloves, the terminal may perform unintendedly.
- Note that unintended operation may be executed if you put the terminal in a pocket or a bag with the backlight ON when [Glove touch] is marked. Let the terminal go to sleep mode when putting the terminal in a pocket etc.

◆ Slide-in function

Configure settings so that you can slide your finger from the edge of the screen to bring up the launcher, from which you can launch applications, or to capture a screen shot, or so that you can slide your finger along lines of text to copy them.

1 From the Home screen,  → [Settings] → [Useful tools] → [Slide-in function]

2 Set [Slide-in function] to ON

3 Set required items

- Tap [Function Description] to show how to use Slide-in launcher, Capture & Draw/Highlight & Copy.

✓INFORMATION -----

- When applications registered to the launcher are updated, the registration may be canceled.

◆ Slide display

Set to display the slide display icon (→P49).

1 From the Home screen, **□**→[Settings]→[Useful tools]→[Slide display]

2 Set [Slide display] to ON

3 [Icon location]→Select an item

◆ Pedometer

Set whether to start the steps counting.

- If you set [Pedometer use] to ON, you can use applications or widgets that utilize steps data.
- To obtain more precisely step information, set your height and weight in [My physical profile] of [Users]. →P141

1 From the Home screen, **□**→[Settings]→[Useful tools]→[Pedometer]

2 Set [Pedometer use] to ON

Deleting all logs : [To remove history]→[EXECUTION]→[YES]

- All logs are deleted including steps being counted.

◆ Precautions on using Step counter

- To count steps accurately, it is recommended that you wear the pedometer correctly (place it in a carrying case and attach the case to the waist belt etc. or when putting the terminal in a bag, put it in a pocket or between partitions), and walk at the speed of 100-120 steps per minute.
- Even when you wear Step counter correctly, if your walking or movement does not reach to the terminal like when moving part of body such as only hands or feet, your steps amount may not be counted accurately.
- Steps may not be counted accurately in the following cases.
 - When the terminal moves randomly as the bag you put the terminal in hits your legs or hip, or when hanging the terminal down from your hip or bag
 - When shuffling, walking randomly wearing sandals or geta (wooden clogs), or when your walking pace was slowed down because of walking in the crowded area etc.
 - When you had a lot of up-and-down motions, shaking or horizontal movements such as repeating standing and sitting, climbing up and down steep slope or stairs, or getting on a vehicle (bicycle, car, train, bus, etc.)
 - When you jogged or did some sports other than walking, or walked extremely slowly
- When shaking or swinging the terminal, counting steps may not be performed accurately.
- When functions available by users and guests are used, the pedometer is treated as the same.

✓INFORMATION

- At the beginning of walking, the figure is not changed because the Pedometer is judging to prevent miscount whether you started walking. As a guide, when you walked for about 4 seconds, the steps to there are added at a time.
- Counted number of steps is saved approximately every 60 minutes. However, the steps that are not counted on the day will be corrected on the next day.
- When pedometer count is not updated, redisplay the screen to reflect as the update.
- By malfunction, repair or other treatments of the terminal, the information of steps may be lost. Note that, even if the information of steps are lost, DOCOMO assumes no responsibility for the loss of any data.

Date & time

Make the settings of date and time.

- To set the date & time and the time zone manually, unmark [Automatic date & time]/[Automatic time zone].

1 From the Home screen,  → [Settings] → [System] → [Date & time]

2 Set required items

Automatic date & time : Set whether to adjust date and time automatically by using network-provided information.

Automatic time zone : Set whether to adjust time zone automatically by using network-provided information.

Set date : Set date manually.

Set time : Set time manually.

Select time zone : Set time zone manually.

Use 24-hour format : Set whether to use 24-hour format.

Accessibility

Make the settings for supporting user operations.

1 From the Home screen,  → [Settings] → [System] → [Accessibility]

2 Set required items

Osusume hint : Set to use the hints according to your operations or usage condition.

Captions : Set whether to display captions or set the language of captions or font size.

Magnification gestures : Set whether to zoom in/out by tapping the screen 3 times.

Font size : Change the font size.

Display size : Enlarge/reduce the size of icons etc. displayed in the screen.

Click after pointer stops moving : Set whether to perform click operation when the pointer is stopped when using a mouse.

High contrast text : Set whether to make the text contrast strong.

Speak passwords : Set whether to output password by sound.

Key misoperation support : Set whether to perform touch operation even if you touch the edge of screen when you hold the terminal in your hand.

Large mouse pointer : Set whether to enlarge the pointer when using a mouse.

Mono audio : Set whether to play monaural sound.

Accessibility shortcut : Set whether to activate Accessibility function by shortcut operation.

Text-to-speech output : Set up text-to-speech output.

Touch & hold delay : Set time to detect a touch and hold.

Color inversion : Set whether to invert the color.

Color correction : Make the settings related to color correction function.

About phone

Display various information of the terminal.

1 From the Home screen,  → [Settings] → [System] → [About phone]

2 Check items

Software Update : Setting steps → P187

Status : Displays battery status and performance, the SIM card information (network name or phone number etc.), address, IMEI (individual serial number), etc.

Legal information : Check Open source license, the Terms of use of Google, etc.

Auth : Check information of certificate or compliant marks.

Model/Android version/Android security patch level/Baseband version/Kernel version/Build number : Display each version or number.

File management

Storage (Internal storage)

Folders in the terminal memory (/storage/emulated/0/) and the data saved in each folder by default are as follows.

Alarms	Alarm sound
Android	Temporary files of installed applications
DCIM	Still images/videos taken with the camera
Download	Files downloaded by Browser etc.
Movies	Videos (except those taken with the camera)
Music	Music files
Notifications	Notification sound
Pictures	Still images (except those taken with the camera)
Podcasts	Files from Podcast (e.g. programs delivered via the Internet)
Ringtones	Phone ringtone

microSD card (External storage)

Save the data of the terminal to a microSD card or import the data of a microSD card to the terminal.



- For microSD cards, refer to "microSD card". →P33

File operations

You can manage data saved in the internal storage and microSD card (rename/delete/copy/move etc. folders and files).

1 From the Home screen,  → [KSfilemanager]

2 Touch and hold a folder/file

- Tap a file to display/play.
- Tap [Home]/[SD Card] at the top of screen to switch displaying storage. Tap [Up] to move to the folder at an upper level.
-  → Tap [Make a new folder] to create a new folder.
-  → Tap [Help] to show how to use File Manager.

3 Select operation

Copy : Copy a folder/file.

Move : Cut the folder/file.

Delete : Delete a folder/file.

Copy to : Copy to a folder that you select a folder/file.

Move to : Move to a folder that you select a folder/file.

Rename : Rename a folder/file.

Add to Bookmark : Add the folder to Bookmark.

Send To : Send the folder/zipped file.

Zip : ZIP compress the folder/file.

UnZip : Decompress the zipped folder/file.

Property : Display property of the folder/file.

Cancel : Close operation menu.

Data communication

Bluetooth® communication

◆ Using Bluetooth function

You can connect the terminal and a Bluetooth device to perform wireless communication or play voice sound or music.

- Note that using Bluetooth connection makes battery consumption faster.
- Wireless communication is not guaranteed for all Bluetooth devices.

✓ INFORMATION

- For information on compatible Bluetooth version, profiles, etc., see "Main specifications". →P191
- Audio of 1Seg can be played with a Bluetooth device compatible with A2DP profile.
- For operations of the Bluetooth device, refer to the operation manual of your Bluetooth device.

❖ Handling precautions when using Bluetooth function

- Connect with another Bluetooth device keeping the line-of-sight distance to 10 m or shorter. Distance available for connection may be shorter if obstacles exist between the terminal and the Bluetooth device or depending on surrounding (wall, furniture, etc.).

- Place a Bluetooth device as far as possible from other electric appliances, audio visual devices and office appliances. A microwave oven strongly affects the connection when it is operated. Connection may not be established correctly when other devices are powered on, or the connection may cause noises on TV or radio or reception difficulty.
- Under strong ambient signals, connection may not be established.
- Radio waves emitted by a Bluetooth device may affect electronic medical equipment. Turn off the terminal and other Bluetooth devices in a train, aircraft or hospital, near an automatic door or fire alarm, and at a place where flammable gases could be generated such as a gas station.

❖ Radio wave interference with wireless LAN

Because a Bluetooth device and wireless LAN (IEEE802.11b/g/n) use the same frequency band (2.4 GHz), if the device is used near a device with wireless LAN capability, radio wave interference may occur, and communication speed may be reduced, noise may occur, or connection may not be established. In this case, turn the wireless LAN device power off, or move the terminal or the Bluetooth device away at least 10 m from the wireless LAN device.

◆ Bluetooth ON/OFF

Set Bluetooth to ON to use Bluetooth function. When you do not use Bluetooth, set it to OFF in order to cut the battery power consumption.

- When activated,  appears on the status bar.
- Turning the power OFF does not change Bluetooth ON/OFF setting.

1 From the Home screen,  → [Settings] → [Wireless & networks] → [Bluetooth]

2 Tap the button at the upper right of the screen to set ON/OFF

◆ Connecting with registered Bluetooth devices

Connect Bluetooth device. You can talk or play back sounds or music using a Bluetooth device, or exchange data to or from a Bluetooth device. And you can enter characters on the terminal with Bluetooth compatible keyboard.

- Set a Bluetooth device to be detectable in advance.
- When connected,  appears on the status bar.
- For profile HFP/HSP/DUN/A2DP, 1 Bluetooth device can be connected simultaneously.
- Bluetooth devices with Qualcomm® aptX™ audio enables you to enjoy music using aptX audio codec.



1 From the Home screen,  → [Settings] → [Wireless & networks] → [Bluetooth]

2 Tap the button at the upper right of the screen to turn [Bluetooth] to ON

- When a Bluetooth device to connect is not displayed, tap [MENU] → [Refresh].

3 Tap a detected Bluetooth device → Enter a passcode (PIN) as required and [OK]/[PAIR]

■ When connection is requested from another Bluetooth device

If a Bluetooth pair setting request screen appears, enter a pass code (PIN) if necessary and tap [OK]/[PAIR].

◆ Sending or receiving data to or from Bluetooth device

You can send data such as Gallery (→P110) and contacts or receive data from a Bluetooth device.

- Set a Bluetooth device to be connected or to be detectable in advance.

<Example> Sending files in Gallery

1 Open Gallery and tap an image

2  → [Bluetooth] → [OK]

- If data has been already sent/received using the Bluetooth function, tap displayed  to connect with Bluetooth device.

3 Tap a Bluetooth device

Open the Notification panel to check if transmission is completed.

<Example> Receiving files from a Bluetooth device

- 1 Send files from a Bluetooth device
- 2 After the file arrival is notified, open the Notification panel → [Bluetooth Share: Incoming file] → [ACCEPT]
 - To check the received files, from the Home screen, [] → [Settings] → [Wireless & networks] → [Bluetooth] → [MENU] → [Show received files].

◆ Canceling connection with a Bluetooth device

When a Bluetooth device such as an earphone microphone or keyboard is connected, cancel it by the following operation.

- 1 From the Home screen, [] → [Settings] → [Wireless & networks] → [Bluetooth]
 - 2 Tap the connected Bluetooth device → [OK]
- ### ◆ Unpairing from Bluetooth device
-
- 1 From the Home screen, [] → [Settings] → [Wireless & networks] → [Bluetooth]
 - 2 Tap the button at the upper right of the screen to turn [Bluetooth] to ON → [] of the Bluetooth device → [FORGET]

◆ Renaming a Bluetooth device

- 1 From the Home screen, [] → [Settings] → [Wireless & networks] → [Bluetooth]
- 2 Tap the button at the upper right of the screen to turn [Bluetooth] to ON → [] of the Bluetooth device → Enter a device name → [OK]

◆ Bluetooth Low Energy setting

Set notification for Bluetooth Low Energy device.

- 1 From the Home screen, [] → [Settings] → [Wireless & networks] → [Bluetooth] → [MENU] → [Bluetooth Low Energy]
- 2 Set required items
 - Alert Notification** : Set whether to notify to compatible devices of incoming calls, new email, etc.
 - Alert Notification Detail Setting** : When Alert Notification is ON, select items to notify (incoming call, docomo mail, Email, Gmail, SMS, alarm, calendar).
 - Find Me Ringtone** : Set whether to emit ringtone when receiving notification from compatible devices.
 - Find Me Ringtone Settings** : When Find Me Ringtone is ON, select from the notification ringtone list.
 - Proximity** : Set notification level for compatible devices when connection is canceled.
 - Connecting compatible device again is needed for reflecting this setting.

Time : Set whether to synchronize time with a Time-compatible device.

- Regardless of the setting, time on the terminal is synchronized with paired Time-compatible device. When the setting is on, time on a Time-compatible device is synchronized with the terminal even if the time on the terminal changes after pairing is complete.

✓INFORMATION

- Find Me Ringtone in Bluetooth Low Energy setting sounds regardless of the Manner mode and volume settings.

NFC communication

NFC is an abbreviation for Near Field Communication and a short range wireless communication method of international standard defined by ISO (International Organization for Standardization). You can use a contactless IC card function, Reader/Writer function, P2P function, etc.

You can send/receive data to/from another NFC compatible device using NFC function.

- For notes when holding over the other device, refer to "Notes when holding over the other device".→P95

◆ Android Beam

Transfer data between the terminal and a Reader/Writer, P2P equipped terminal.

- To use Android Beam, set to allow data transfer beforehand.
- When "Lock NFC/Osaifu-Keitai" is activated, Android Beam cannot be used.
- Android Beam cannot be used on some applications. Available data varies by applications.
- Data transfer is not guaranteed for all Reader/Writer, P2P equipped terminals.

1 From the Home screen, →[Settings]→[Wireless & networks]→[NFC/Osaifu-Keitai Settings]

- When a password setting screen appears, set a password.
- If [Lock NFC/Osaifu-Keitai] is marked, unmark the checkbox.

2 Mark [Reader/Writer, P2P]

3 [Android Beam]→Tap the button at the upper right of the screen to turn [Android Beam] ON

❖ **Transferring content displayed on the screen**

You can transfer content shown on the screen such as websites, only by holding  mark over each other's terminal.

1 Activate each other's Android Beam function

2 Show website, content, etc. to transfer on the senders terminal

3 Hold mark over each other's terminal

- When the terminal detects a compatible device, notification sounds. The screen content on the sender's terminal is zoomed out and "Touch to beam" appears.
- When the operation is being performed by the sender using the shared menu, hold  marks over each other to start transferring automatically.

4 Tap the screen content to transfer

The content shown on the sender's terminal is transferred to the receiver's terminal.

External device connection

Connecting with a PC

◆ Operating data on the terminal from a PC

Connect the terminal and a PC using USB cable A to B 01 (optional) to operate the data in the internal storage or microSD card of the terminal.

- The PCs of Windows 7, Windows 8.1 and Windows 10 are supported. Note that DOCOMO does not guarantee the operations of every PC.

1 Insert the microUSB plug of the USB cable into the external connection jack on the terminal and insert the USB plug of the USB cable into a USB connector on a PC

2 Open the Notification panel → Tap the notification of USB option

3 Select the option of the USB connection

Charge this device : Only charge the battery.

Transfer files : Transfer music or videos via the MTP compatible file-managing software.

Transfer photos (PTP) : Transfer photos or movies to PC etc. which are not compatible with MTP.

USB tethering : Setting steps → P129

4 Perform target operations

✓INFORMATION

- When a microSD card is not mounted on the terminal, the microSD card cannot be recognized by a PC. In such case, from the Home screen, tap  → [Settings] → [Display/Sound/ Apps] → [Storage] → [SD card] → [MOUNT] and then connect the terminal to a PC.
- When [Transfer photos (PTP)] is selected, data on the internal storage in the terminal can be operated from the PC only when microSD card is removed.

Connecting with a printer

◆ Connecting with a printer using cloud print

Using the Google Cloud Print™ function, you can connect the terminal with a printer which you usually use and print a images displayed in the terminal or web pages in the browser. Also, you can connect a cloud compatible printer as a printer that is related to a Google Cloud Print account via Internet connection without a PC.

- To use Google Cloud Print, you need to set up a Google account on the terminal.
- Items or displays may vary depending on the version of the application.
- For details on Google Cloud Print, refer to Help of Google Cloud Print on the Google website.

1 From the Home screen,  → [Settings] → [System] → [Printing] → [Cloud Print]

2 Tap the button at the upper right of the screen to turn [Cloud Print] to ON

- When you have already set up a printer connection with your Google account, the cloud print menu including printers that can be connected for printing is displayed.
- If you do not set your Google account, in Cloud Print screen, [MENU] → [Settings] → [Add account] and set a Google account.
- If the connection setup of the daily used printer for the PC printing or the cloud compatible printer are not made, in Cloud Print screen, tap [MENU] → [Add printer] to set up the connection.

◆ Connecting with a Wi-Fi printer

You can easily connect the terminal with a printer using "Epson Print Enabler" or "Canon Print Service" that search a Wi-Fi compatible printer manufactured by Seiko Epson or Canon. For other Wi-Fi compatible printer, if the Google Cloud Print compatible application is available in Play Store, you can download the application and use the printer.

- Set Wi-Fi to ON in advance and connect the terminal to the same access point as a Wi-Fi printer. → P123

1 From the Home screen,  → [Settings] → [System] → [Printing]

2 [Epson Print Enabler]/[Cannon Print Service]

3 Tap the button at the upper right of the screen to turn [Epson Print Enabler]/[Canon Print Service] to ON

- Printers that can be connected appear.

✓INFORMATION -----

- For Wi-Fi printers manufactured by Seiko Epson/Canon, refer to the following websites.

〈Seiko Epson〉 <http://www.epson.jp/products/colorio/> (in Japanese only)

〈Canon〉 <http://canon.jp/pixus> (in Japanese only)

- For instructions on a Wi-Fi printer, refer to the printers operation manual.

◆ Print

<Example> Printing a web page displayed with "Browser" application

1 While a web page is displayed, slide down the screen to display the top part of the web page → [MENU] → [Print]

Print setting screen for the connected printer appears.

- When using a cloud print, select [Save to Google Drive]/[Save as PDF] to save printing data to Google Drive or to create PDF data.

2 Set required items

- Set printer, paper size, etc.

3 Start printing

✓INFORMATION -----

- Printable data varies depending on the status of support for printing function of used application.

Connecting with other devices

◆ Displaying on Wi-Fi Miracast device via Wi-Fi connection

Show videos, images, etc on TV screen or displays by connecting the terminal to a Wi-Fi Miracast device through Wi-Fi connection.

1 From the Home screen,  → [Settings] → [Display/Sound/Apps] → [Display & Wallpaper]/[Sound] → [Screen/Music Cast] → Mark [Enable wireless display]

2 Tap a detected Wi-Fi Miracast device

Disconnecting Wi-Fi Miracast device : Tap a connected device → [DISCONNECT]

✓INFORMATION -----

- When connecting a device that does not support HDCP, images or sounds are not output properly. Depending on content, external output may be prohibited from the content provider or may be suppressed due to a performance problem.
- When you receive a call during connection, incoming call screen also appears on the connected device.
- With some applications, content appears on the connected device, and operations such as playback can be performed from the terminal.

International roaming

Outline of international roaming (WORLD WING)

With the international roaming (WORLD WING), you can use the terminal without changing phone number or mail address in the service area of the overseas network operator affiliated with DOCOMO. You can use Phone and SMS without changing settings.

For details on the international roaming (WORLD WING), refer to NTT DOCOMO website.

<https://www.nttdocomo.co.jp/english/service/world/roaming/>

■ Available networks

- You can use the terminal within the service area of LTE network, 3G network and GSM/GPRS network. Also, you can use the terminal in countries/regions where 3G850MHz/ GSM850MHz is supported.

✓INFORMATION

- For the country codes/international call access number/ Universal number international prefix/compatible countries and regions and overseas network operators, refer to NTT DOCOMO website.

Available services for overseas

Main communication services	LTE	3G	3G850	GSM (GPRS)
Phone	○	○	○	○
SMS	○	○	○	○
Mail*	○	○	○	○
Browser*	○	○	○	○

* To use data communication during roaming, set Data roaming setting to on. → P173

✓INFORMATION

- Some services may not be available depending on the network operator or network overseas.
- You can confirm the name of the connected network operator in the detailed screen displayed by tapping the panel switch of radio wave condition on the Notification panel (→ P52).

Before using the terminal overseas

◆ Before leaving Japan

To use the terminal overseas, check the following in Japan.

■ Subscription

Check if you subscribe to WORLD WING. For details, contact "General Inquiries" on the last page of this manual.

■ Charging

For details on charging, refer to NTT DOCOMO website.

■ Usage charge

Overseas usage charges (call and packet communication) differ from those in Japan. For details, refer to NTT DOCOMO website.

- Since some applications automatically perform communications, packet communication charges may become high. For operation of applications, contact the application providers.

◆ Advance preparation

■ About setting network service

If you subscribe to network services, you can use network services such as Voicemail service, Call forwarding service, Caller ID request service, etc., even overseas. Some network services are not available.

- To use network services overseas, you need to set Remote access to activate. You can set Remote access in the country you visit. From Japan (→P73), from overseas (→P176)
- Even if the setting/canceling operation is available, some network services cannot be used depending on overseas network operators.

◆ After arriving overseas

When you arrive overseas and turn the terminal ON, a connection to the available network is established automatically.

■ Connectivity

When you have set [Network operators] in [Cellular networks] to [Select automatically], optimum network is automatically selected.

◆ Settings for overseas use

- If you release SIM lock and use SIM by a carrier other than NTT DOCOMO to perform data communication, set an access point (APN) before use. →P131

❖ Setting Data roaming

To perform packet communications overseas, set Data roaming settings to ON.

1 From the Home screen,  → [Settings] → [Wireless & networks] → [More] → [Cellular networks]

2 [Data roaming] → Check the contents on the Attention screen, [OK]

❖ Setting Network operators

By default, the terminal is set to automatically search and switch to an available network. To switch network manually, perform the following operations.

1 From the Home screen, →[Settings]→[Wireless & networks]→[More]→[Cellular networks]→[Network operators]

Available networks are searched for and displayed.

- When a message notifying that the network search is not available, confirm the content and tap [OK].

2 Select a network of the network operator

✓INFORMATION -----

- To switch networks automatically, from the Home screen, →[Settings]→[Wireless & networks]→[More]→[Cellular networks]→[Network operators]→Tap [Select automatically].

❖ Setting Network Mode

1 From the Home screen, →[Settings]→[Wireless & networks]→[More]→[Cellular networks]→[Network Mode]

2 [4G/3G/GSM(Auto)]/[3G/GSM]/[GSM]

✓INFORMATION -----

- To set network mode automatically, from the Home screen, →[Settings]→[Wireless & networks]→[More]→[Cellular networks]→[Network operators]→Tap [4G/3G/GSM(Auto)].

❖ Date & time

When [Automatic date & time]/[Automatic time zone] in [Date & time] is marked, the date, time and time differences of the terminal are corrected by receiving information related to time and time differences from the network of overseas telecommunications carrier you connect to.

- Correction of the time or time differences may not be performed correctly depending on the network of overseas network operator. In that case, set time zone manually.
- Timing of correction varies by the overseas network operator.
- "Date & time"→P160

❖ About inquiries

- For loss or theft of the terminal or docomo nano UIM card, immediately contact DOCOMO from the spot to take the necessary steps for suspending the use. For inquiries, see the last page of this manual. Also, you can take the steps for suspending the use from My docomo. Note that you are still liable for the call and communication charge incurred after the loss or theft occurred.
- For using from land-line phone, entering "International call access code" or "Universal number international prefix" for the country is needed.

Making/Receiving a call in the country you stay

◆ Making a call to outside country you stay (including Japan)

You can make a call from the country you stay to another country using the international roaming service.

- For details on available countries, network operators, etc., refer to NTT DOCOMO website.

1 From the Home screen,

2 [Dial]→+(Touch and hold "0")→Enter "Country code-Area code (City code) without leading 0 and phone number"

- In some countries and areas such as Italy, "0" is required.
- To call an overseas WORLD WING user, enter "81" (Japan) for the country code regardless of whether the party is in or out of the country you stay.

3

Making a video call : →[Video call]

✓INFORMATION -----

- For details about video call, see "Making a call/video call".→ P67
- If [Automatic conversion] for [International dial assist] is marked and when you call someone in Japan, enter a phone number from City code→→Tap [Convert number].

◆ Making a call inside the country you stay

You can make a call to the other party's land-line phone or mobile phone in the same way you do in Japan.

1 From the Home screen,

2 [Dial]→Enter a phone number

- Start with the area code (city code).
- If you make a call to the party using "WORLD WING", make a call as an international call to Japan (by entering the country code "81" (Japan)) even when making a call in the country you stay.

3

◆ Receiving a call inside the country you stay

You can receive a call in the same way as you do in Japan.

✓INFORMATION -----

- An incoming call during the international roaming is forwarded internationally from Japan regardless of which country the call is from. A caller is charged for a call fee to Japan, and the receiver is charged for a reception fee.

❖ Making a call to your terminal

■ To have the other party in Japan call you overseas

Have your phone number dialed as a domestic call in Japan.

■ To have the other party make a call from the outside Japan to the terminal in the country you stay

You have to receive a call through Japan no matter where you are; therefore, the other party needs to enter the international call access code and "81" (Country code of Japan).

International call access code of the country of the caller -81-90 (or 80, 70) - XXXX - XXXX

Setting international roaming

Make settings to use the international roaming service.

- The settings may not be made depending on overseas network operator.

1 From the Home screen, → → [Call settings] → [Roaming settings]

2 Select the item

Incoming call restriction while roaming : Restrict incoming calls during international roaming.

Incoming call notification while roaming : Notify you of missed calls when you are out of service area etc. during international roaming via SMS.

Roaming guidance : Notify a caller of international roaming with a guidance indicating it is a call during international roaming.

International dial assist : Setting steps→P176

Network service : Setting steps→P176

◆ Setting International dial assist

1 From the Home screen, → → [Call settings] → [Roaming settings] → [International dial assist]

2 Select the item

Automatic conversion : Add an international prefix or country code automatically.

Country code : Select a country code used for Automatic conversion.

International prefix : Select an international prefix used for auto conversion.

◆ Network service (overseas)

Set the network services such as the voicemail service to use overseas.

- Activate "Remote operation settings" in advance.→P73
- If you make the settings overseas, you are charged a call fee to Japan from the country you stay.
- The settings may not be made depending on overseas network operator.

1 From the Home screen, → → [Call settings] → [Roaming settings] → [Network service]

2 Select a service

Remote operation (charges apply) : Set whether to activate the remote operation.

Caller ID notification request service (charges apply) : Play the guidance of requesting a caller IC notification when receiving a call with an unknown number.

Incoming call notification while roaming (charges apply) :
→P176

Roaming guidance (charges apply) : →P176

Voicemail service (charges apply) : Take messages of callers when you are in a place where the radio wave cannot reach or when you turn off the power.
(Subscription is required)

Call forwarding service (charges apply) : Forward incoming calls to another mobile phone etc. that is registered in advance. (Subscription is required)

3 Operate according to the onscreen instructions or voice guidance

After returning to Japan

When you return to Japan, the terminal is connected to DOCOMO network automatically. If connection is failed, perform the following operations.

- Set [Network Mode] of [Cellular networks] to [4G/3G/GSM(Auto)]. →P174
- Set [Network operators] in [Cellular networks] to [Select automatically]. →P174

Appendix/Index

Troubleshooting (FAQ)

◆ Troubleshooting

- When you have a vague idea of malfunctioning, you can perform diagnosis by yourself.
For details, refer to NTT DOCOMO website.
<https://www.nttdocomo.co.jp/support/trouble/repair/> (In Japanese only)
- Check for the necessity of software update first, and update the software if necessary. →P187
- If it does not improve after confirming the check items, contact "Technical Inquiries & Repairs" (in Japanese only) on the last page of this manual or a repair counter specified by DOCOMO.

■ Power supply and charging

- **The terminal cannot be turned ON.**
Is the battery exhausted?
- **The screen freezes/The terminal cannot be turned off.**
If the screen does not respond or the power cannot be turned off, press and hold  and volume up key for 8 seconds or more and release the fingers after the screen is turned off to shut down the power forcibly.
- * Note that data and settings may be erased since that is an operation for shutting down the power forcibly.

- **Cannot charge the battery (the indicator LED does not turn on or blinks).**
 - Is the adapter's power plug inserted to the outlet or accessory socket correctly?
 - Are the adapter and the terminal set correctly? →P36
 - In case of using an AC Adapter (optional), is the microUSB plug of AC adapter connected to the terminal correctly? →P36
 - Is the PC turned on when you connect the terminal with the PC via USB connection?
 - If you call, perform communication or operate functions for a long time while charging the battery, temperature of the terminal may be raised and the indicator LED (red) may turn off. In high temperature status, the terminal stops charging for safety. Wait a while until the temperature is lowered and retry to charge.

■ Operations/Display

- **No operations are performed even by tapping or pressing keys.**
 - Is the terminal turned off? →P37
 - Is the terminal in sleep mode? Press  to unlock. →P53
 - Is Child proof enabled? →P57
 - When [Glove touch] is marked, operation with gloved finger upright may not work properly. Tilt your finger to bring the pad of the finger into contact with the touch panel when operating the terminal. →P158

● **The operation time provided by the battery is short.**

- Running multiple applications increases battery consumption and usage time may become short. Exit from applications which you are not using as follows.
 - Exiting running application→P56
 - Exiting applications with  (Back)
- To see FAQ about arrows such as setting of saving the battery power or how to use the terminal conveniently, refer to @Fケータイ応援団 (@F mobile phone supporters) or arrows@ (<http://atfe.fmworlnd.net/at/>) (In Japanese only).
- Is the terminal left for a long time under the state of out of service area? Out of service area, a lot of power is consumed to search available radio waves. If you are out of service area for a long time, set Airplane mode to ON or turn off the terminal.→P37 , P128
- The operation time provided by the internal battery varies by the operating environment and battery deterioration.
- The internal battery is a consumable accessory. The usage duration of the battery per 1 charge decreases gradually each time the battery is recharged. When the operation time is too short even if the terminal is fully charged, contact "Technical Inquiries & Repairs" (in Japanese only) on the last page of this manual or a repair counter specified by DOCOMO.
- Set the Wi-Fi or Bluetooth to OFF when you do not use the function. →P123 , P165

● **The docomo nano UIM card is not recognized.**

Is the docomo nano UIM card installed in the right direction?→P31

● **The screen reacts slowly when a touch panel is tapped/ key is pressed.**

When large amount of data is saved in the terminal or transferring large-size data between the terminal and microSD card, the reactions on the screen may be delayed.

● **The terminal, etc. become hot while operating/charging.**

While operating or charging, or if you call or watch 1Seg, etc. for a long time while charging the battery, the terminal, internal battery and adapter may become hot. There is no problem and you can continue to use them.

● **The terminal becomes hot while operating/charging.**

If high temperature of the terminal continues, charging or some functions may be disabled.

● **The terminal becomes hot and the power turns OFF.**

If you activate several applications, use camera, connect to the Internet for a long time while charging the battery, etc., temperature of the terminal may be raised. When the terminal is in high temperature state for a long time, charging or functions may stop or screen brightness may be adjusted. And the power of the terminal may shut down to prevent you from burns.

● **The display is dim.**

- Have you changed any of the following settings?
 - Emergency mode→P40
 - Brightness→P133
 - Sleep→P134
- When the terminal is in high temperature state for a long time, the display may become dim.

● **Display flickers.**

If [Automatic brightness] of Brightness level is marked, display backlight automatically changes according to the ambient brightness.→P133



● **The display has afterimages.**

If the same screen is displayed for a while, afterimages of that screen may remain even after the screen is changed for a certain operation.

● **The clock is not on time.**

The clock time may be wrong when the terminal stays powered on for a long time. Make sure that [Automatic date & time]/[Automatic time zone] of Date & time are marked, and then turn OFF and ON the terminal in a place with good signal conditions.→P160

● **Terminal operation is unstable.**

- Instability may be caused by application that you installed after purchasing the terminal. If the symptom is improved when you boot the terminal in safe mode (function for booting in near default state), uninstalling the installed application may improve the symptom. Boot the terminal in safe mode by one of the following procedure.
 - Press and hold  until the phone options menu appears→Touch and hold [Power off]/[Restart]→[OK]
 - With the power turned off, press and hold  for 2 seconds or more. Immediately after the docomo logo disappears, press and hold the volume down keyWhen safe mode is booted, [Safe mode] is displayed at the lower left of the screen. To exit the safe mode, turn the power OFF and ON.

- * Back up the necessary data before using safe mode.
- * Some applications or widgets may be hidden.
- * Safe mode is not a normal booting state. To use ordinarily, exit the safe mode.

● **Operations are not possible when tapping the screen.**

- Do you operate with a fingernail or foreign object on the screen?
- Do you put a protective sheet or sticker on the display? Depending on the protective sheet, you cannot operate the terminal correctly.
- Do you operate with the touch panel wet or with your finger wet with sweat or water?
- Do you operate under water?
- Touch the touch panel with your finger directly to operate the terminal.
- Is Child proof enabled?→P57

● **Operations are slower/Application operation is unstable/Some applications are not activated.**

Operation becomes unstable if the terminal is low on memory. When a message indicating the memory space is short is displayed, delete unnecessary applications.→P93, P138

● **Applications cannot be operated properly (applications cannot be activated/errors occur frequently).**

Are there any applications being disabled? Enable disabled applications, then retry to operate.→P138



● **Data is not displayed normally/Normal touch panel operations are not possible.**

Turn the terminal OFF and ON.→P37

■ **Phone/Voice call**

● **Cannot dial by tapping .**



Do you set Airplane mode?→P128

- **During a voice call, the distant party's voice is hard to listen to or too loud.**
Adjust the listening volume. Turn on Voice clear and Voice slowing to make the other party's voice easy to understand.→P70
- **Calls are not connected (Even when moving,  does not disappear or although radio waves are enough, making/receiving calls is unavailable).**
 - Turn the power OFF and ON, or reattach the docomo nano UIM card.→P31 , P37
 - Due to the nature of radio waves, making/receiving calls may be unavailable even when "not out of service area" or " appears on the display for the radio wave condition". Move to call again.
 - Do you set call restriction such as Call Blocking?→P74
 - Have you changed network type (4G/3G/GSM)?→P174
 - Due to the crossing of radio waves, at the crowded public places, calls/emails are crossed and the connection status may not be good. Move to other place or call again at other time.
- **The ringtone does not sound.**
 - Is [Ring volume] in Volumes set to 0?→P136
 - Have you activated any of the following functions?
 - Manner mode→P137
 - Airplane mode→P128
 - Privacy mode→P149
 - Do you set call restriction such as Call Blocking?→P74
 - The followings are set to 0 seconds?
 - [Set answer time] in the Phone memo setting→P73
 - [Ring time settings] in Voicemail service→P73
 - [Ring time] in Call forwarding service→P73

- **Calls cannot be made.**
 - Is the docomo nano UIM card installed in the right direction?→P31
 - Do you enter a phone number from City code?
 - Do you set Airplane mode?→P128
- **Mail**
 - **Mail is not received automatically.**
 - Is Emergency mode set→P40
 - Receive interval in NX! Mail Account settings is set to [Do not receive automatically].→P85
- **1Seg · Camera**
 - **Cannot watch 1Seg**
 - Are you out of digital terrestrial broadcasting service area or in an area with poor signal strength?
Extend the 1Seg antenna fully, and turn the antenna around or move to other place. Signal reception may be improved.→P98
 - Do you use the channel list matching with your watching area?→P102
 - **Photos and videos taken with the camera are blurred.**
 - Check if clouds or dirt attach to the lens of camera.
 - Automatic still image shooting is available in the camera of the terminal, but you can also focus using the touch focus function.→P105, P108

■ Osaifu-Keitai

● Osaifu-Keitai function is unavailable.

- When Omakase Lock is set,  appears on the status bar and Osaifu-Keitai functions are unavailable regardless of the NFC/Osaifu-Keitai lock settings.
- Is Lock NFC/Osaifu-Keitai activated?→P96
- Do you place  mark of the terminal over IC card reader?→P94, P95

■ Overseas use

● Cannot use the terminal even when is displayed overseas.

Do you subscribe to WORLD WING? Check if you subscribe to WORLD WING.

● is displayed, and you cannot use the terminal overseas.

- Are you at a location that is outside of the international roaming service area, or where the signal is weak? See NTT DOCOMO website to check if it is the available service area or the available overseas network operator.
- Change network mode type to [4G/3G/GSM(Auto)].→P174
- Set the network operator to [Select automatically].→P174
- It may be recovered by turning the terminal OFF and ON.→P37

● Cannot use the terminal suddenly while using overseas.

Does usage amount exceed the limit of maximum charges for use? For use of International roaming (WORLD WING), the limit of maximum charges for use is set in advance. When it exceeds the limit of maximum charges for use, pay the charges.

● There is no incoming call overseas.

Is Incoming call restriction while roaming set to [Activate restriction]?→P176

● No caller ID is notified/A notified caller ID is different from that of the caller/Functions for using contents saved in the phonebook or those using Caller ID notification do not operate.

Even when a caller notifies its caller ID, it is not displayed on the terminal unless notified from the network or network operator used. And, a notified caller ID may be different from that of the caller by some networks or network operators you use.

● Cannot perform data communication overseas.

Check the data roaming settings.→P173

■ Data management

● Data saved in microSD card is not displayed.

Reattach the microSD card.→P34

● Data transfer is not performed.

Do you use USB HUB? If you use USB HUB, operations may not be performed correctly.

● [No thumbnail] appears when displaying images/Gray frame appears in the image list.

[No thumbnail] or a gray frame may appear if image data is broken.

■ Bluetooth

- **The terminal cannot be connected to a Bluetooth device/
A Bluetooth communication device cannot be found
from the terminal.**

Make Bluetooth device (commercially available) detectable and then register the device on the terminal. If you delete already registered device and register the device again as a new device, delete the registrations on both the terminal and Bluetooth device (commercially available), and then perform registration of the devices.

- **Calls cannot be made from the terminal connected to an external device such as car navigation or handsfree device.**

If calls are made several times when the other party does not answer or is out of service, the call to this number may be disabled. In this case, turn the terminal OFF and ON.

■ Maps/GPS function

- **Cannot set AUTO-GPS service information.**

- Is AUTO-GPS function disabled due to battery low? If AUTO-GPS is disabled by Lower-power operation settings, AUTO-GPS service information cannot be set. In this case, set Lower-power operation settings to [Not suspend] or charge the battery. →P35 , P142
- Mark [AUTO-GPS] operation settings. →P142
- Is the GPS function OFF? When the GPS function is OFF, AUTOGPS function stops. →P114

■ Others

- **Data saved in USB mass storage is not displayed.**

Reattach the USB mass storage.

◆ Error messages

- **Memory space is full**

The terminal is low on memory. If you keep using, some functions and applications may not be operated.

Open setting screen to select unnecessary apps, then press "Uninstall" to uninstall them.

Displayed when available memory of the terminal is low. Tap [Setting screen] to delete unnecessary applications. Alternatively, end running applications or clear cache of applications to increase memory space. →P56, P138

- **All voice services are blocked./Voice service is blocked./
Emergency service is blocked./Data service is blocked.**

Phone line or packet communication facilities are broken down or line or packet communication network is very busy. Wait a while and then operate again.

- **PUK is locked.**

If you enter a wrong PUK code of the docomo nano UIM card 10 times consecutively, this message is displayed. Contact a sales outlet such as docomo Shop. →P145

- **No SIM card.**

Check if the docomo nano UIM card is installed to the terminal correctly. →P31

- **SIM card is locked.**

Displayed when you turn on the terminal with PIN code enabled. Enter the correct PIN code. →P152

- **SIM card is PUK-locked.**

Displayed when the docomo nano UIM card is locked by PUK. Unlock with correct PUK code. →P152

● **SIM card error**

SIM card removed. Phone will restart.

It may appear when IC of docomo nano UIM card cannot be loaded because of dirt or when docomo nano UIM card is removed with the power ON, but it is not malfunction. Clean the IC of docomo nano UIM card regularly. Do not remove docomo nano UIM card with the power ON. The terminal may not operate normally.

● **An error occurred during download processing.**

If the error message appears several times, restart the terminal and perform the update again.

Anshin Enkaku Support

By sharing screens of your terminal with DOCOMO, you can receive technical support to make settings, use applications, connect with peripheral devices such as a PC. (In Japanese only)



- This service is not available when your docomo nano UIM card is not inserted, during international roaming, or in Airplane mode.
- Anshin Enkaku Support is a charged service requiring subscription.
- Some operations and settings are not supported.
- For details of Anshin Enkaku Support, refer to NTT DOCOMO website.

1 Call Support center for Anshin Enkaku Support.

From DOCOMO mobile phones (In Japanese only) : (No prefix) 15710 (toll free)

From land-line phones (In Japanese only) : ☎ 0120-783-360

Business hours: 9:00 a.m. to 8:00 p.m. (open all year round)

- To call from the terminal to Anshin Enkaku Support center, from the Home screen,  → [遠隔サポート (Enkaku support)] → [このスマートフォンから発信する (Make a call from this smartphone)] → Tap .

2 From the Home screen, → [遠隔サポート (Enkaku support)]

3 [遠隔サポートの接続画面に進む (Go to Remote support connection screen)]→[同意する (Agree)]

4 Enter connection number notified by DOCOMO

5 Remote support starts when you are connected

Warranty and After-Sales Service

❖ Warranty

- The terminal is provided with a written warranty. Be sure to receive it. Check the written contents and items such as "販売店名・お買い上げ日 (Shop name/date of purchase)" and keep it in a safe place. If it does not contain the necessary information, immediately contact the shop where you bought it. The warranty is valid for a period of one year from the date of purchase.
- The specifications and appearance of this terminal are subject to change for better without notice.
- Since troubles, repair or other handling of the terminal may cause contents in the phonebook etc. to be altered or deleted. DOCOMO recommends making a copy of the Phonebook data etc., in case.
- * Data such as phonebook entries in the terminal can be saved in a microSD card.
- * Data such as phonebook entries can be backed using docomo cloud.

❖ After Sales Services

■ When problems occur

Before repair, read "Troubleshooting" in this manual for detailed information (→P178). If the problem still persists, contact "Technical Inquiries & Repairs" (in Japanese only) on the last page of this manual.

■ If the result of inquiries indicates that a repair is required

Take the terminal to DOCOMO-specified repair office. Be sure to check the opening hours of the office before you go. The warranty must be presented to receive warranty service. Note that, repair may take longer time depending on the state of damage.

■ In the warranty period

- The terminal is repaired at no charge subject to the conditions of the warranty.
- Make sure to bring the warranty for repair. You will be charged even during the warranty period if the warranty is not presented or the trouble or damage is caused by your inappropriate handling (such as damage to external connection terminals, display, etc.), or when it is not repaired by a repair counter specified by DOCOMO.
- The subscriber is charged even during the warranty period for the repair of failures caused by the use of devices or consumable items that are not DOCOMO-specified.

■ Repairs may not be possible in the following cases.

- When, as the result of inspection, corrosion is found due to exposure to water, condensation or sweat, or any of the internal boards are damaged or deformed (damage to the external connection terminals, display, or cracked body could be the case as well).
- When you have sent the terminal to a repair shop other than a DOCOMO-specified repair office
- * Even in case that a repair is possible, since those conditions are outside the range of the warranty, a repair is charged.

■ After expiration of the warranty

All repairs that are requested are charged.

■ Replacement parts

Replacement parts (parts required to maintain functions) will in principle be kept in stock for 4 years after termination of production. For details about technical inquiries and repairs, see NTT DOCOMO website.

<https://www.nttdocomo.co.jp/support/trouble/repair/shop/compatible/index.html> (In Japanese only)

However, depending on the defective portion, repair may not be possible because of a shortage of repair parts. For details, contact DOCOMO-specified repair office.

■ Notes

- Never modify this terminal.
 - May cause fire, injuries or malfunction.
 - The modified terminal may be repaired only if the owner agrees on that all the modified parts are restored to the original conditions. However, repairs may be refused depending on the modifications.

- The following cases may be regarded as modifications.
 - A sticker etc. is put on the display or key part
 - The terminal is embellished with adhesive material etc.
 - Exteriors are replaced with other than DOCOMO's genuine parts
- Repair of failures or damage caused by modification is charged even during the warranty period.
- Do not remove the nameplate sticker on the terminal. Note that if the nameplate sticker is removed or is replaced with a different sticker, it may disqualify the terminal from repairs.
- Function settings and information may be cleared (reset) by malfunctions, repair or other handling of the terminal. Should that happen, set up the functions again. Depending on the setting, a packet communication charge may be applied.
- If repair is executed, MAC address for Wi-Fi and Bluetooth address may be changed regardless of malfunction part.
- Take care not to bring an object that is easily affected by magnetism such as a cash card near to the terminal because the card may become unavailable.
- This terminal is waterproof. However, if inside of the terminal gets wet or moist, turn the power off immediately, and bring the terminal to a repair office as soon as possible. Note that repair may not be possible depending on the condition of the terminal.

Data you created and downloaded data

Note that data you created or data you retrieved or downloaded from sources other than your terminal may be changed or lost when you change the model or have repairs done to the terminal. DOCOMO shall have no liability for any change or loss of any kind. Note that DOCOMO is not liable for a packet communication charge of re-downloading data. Under some circumstances, DOCOMO may replace your terminal with its equivalent instead of repairing it. In that case, we cannot transfer these data to replaced products except for some data.

Software update

◆ About Software Update

Software Update is a function that checks if update is necessary, and if required, download and install software to update.

When update is required, it is notified with  (Software Update) on the status bar or in the NTT DOCOMO website.

- Software Update includes the following contents, etc. To use the terminal in safety and more comfortably, be sure to upgrade to the latest version.
 - Improving and adding functions
 - Operability enhancement
 - Improving quality
 - Security patch update

✓INFORMATION -----

- Updating can be done even when data saved to the terminal is remaining; note that data may not be always secured depending on the conditions of your terminal (such as malfunction, damage, or water leak). You are recommended to back up necessary data beforehand. However, some data may not be backed up.

❖ Cautions

- When updating is performed, restoring the previous software is not possible.
- When updating, the private information concerning the terminal (model, serial number, etc.) is automatically sent to the server of DOCOMO. DOCOMO does not use the sent information for purposes except software update.
- When the packet communication is used via Xi/FOMA, communication fee does not occur while downloading.
- For update using packet communication, docomo nano UIM card subscribed to docomo is required. For using packet communication, depending on the update contents, subscription to sp-mode may be required.
- Making/receiving calls, communications functions and other functions are disabled during installation.
- During installation, all key operations become disabled and installation cannot be canceled on the way.
- After the updating is complete, the terminal restarts.
- When updating is performed, some settings may be initialized. Make the settings again.
- When PIN code is set, the PIN code entry screen appears in the reboot step after rewriting and you need to enter PIN code.
- If updating failed and all operations become disabled, please contact the terminal to DOCOMO-specified repair office.
- SMS sent during updating is stored in the SMS center.
- Updating may take time.

- Updating is unavailable in the following cases.
 - During a call
 - When 圏外 (out of service area) is displayed
 - Tethering in use as an access point
 - When date or time is not set correctly
 - When the remaining battery is not sufficient
 - When the terminal is low on available memory
 - When the basic software is altered
 - When the terminal is being used by other than the owner/guest.
- Exit from all applications before installing.
- Update software when the terminal battery is fully charged.
- Do not turn off the terminal while updating.
- It is recommended that this terminal be put in a place with good reception and not be moved while downloading. The update may stop when it is put in a place with bad reception.
- When it does not need to update, "No upgrade is needed. Use it as it is." appears.
- For update available period, refer to NTT DOCOMO website.

◆ Updating software

- When the terminal needs to update, you are required to perform the installation. Open the Notification panel→Tap the notification→[Install].

■ Changing the automatic update setting

- 1** From the Home screen, →[Settings]→[System]→[About phone]→[Software Update]→Tap the "Auto download" button and set to ON/OFF

- When "Auto download" is set to OFF, operate "When the icon is not displayed on status bar" (→P189).

■ When the icon is not displayed on the status bar

Perform the update by the following operations.

1 From the Home screen, → [Settings] → [System] → [About phone] → [Software Update] → [Update now]

Downloading starts.

2 When the message to start the installation appears, tap [OK]/[Install].

- Depending on the update contents, the confirmation screen about updating appears after tapping [Update now].
- When the confirmation screen appears, follow the procedure below.

① Select an upgrade method

Perform now (only via Wi-Fi) : Immediately download the update file via Wi-Fi connection.

Perform at scheduled time (via Wi-Fi/Xi) : Via Wi-Fi connection or Xi/FOMA, the update file will be downloaded automatically at the reserved time.

- If download via Xi/FOMA is not available, [Perform at scheduled time (only via Wi-Fi)] appears. When the sp-mode is not set, the update cannot be performed by tapping [Perform at scheduled time (only via Wi-Fi)]. Use Wi-Fi.

② Select operation

Download and Install : After downloading is complete, the installation starts automatically. If you do not tap [OK], the installation starts 10 seconds after.

Download : When downloading of the update file is complete, the installation will not start automatically. To install, you are required to perform the installation.

✓ INFORMATION

- When the latest software is applied to the terminal, "No upgrade is needed. Use it as it is." appears.
- If downloading stops on the way, already downloaded data is retained for up to 14 days. To resume downloading, resume from  (Download stopped) on the notification panel.
- When [Perform at scheduled time (Wi-Fi/Xi)] is selected, time for download is automatically set. Changing start time is unavailable. If you do not want to download at the automatically set time, tap [Software Update] → [Back] and then tap [Perform now (only via Wi-Fi)] to download the update file.

◆ Updating applications

- After updating, check if there is an update for application. Operations may become unstable or function may not work properly without updating the application. Be sure to upgrade to the latest version.

■ Updating from the notification icon

After the updating is complete, the terminal restarts and the notification icon  (Updating has been completed) appears. Open the Notification panel → [Updating has been completed] → [OK] to update applications in the update list.

■ Updating from Play Store

From the Home screen, [Play Store] → Flick right the left edge of the screen → Update each application in [My apps & games].

✓ INFORMATION

- For OS version support information on each application, contact the application provider.

Main specifications

Phone

Product name		F-05J
Size		Approx. 144mm (H) × 72mm (W) × 7.8mm (T)
Weight		Approx. 141g
Internal memory		ROM : 16 GB*1 RAM : 2 GB
Continuous stand-by time *2, 3	FOMA/3G	Stationary (Automatic): Approx. 780 hours
	GSM	Stationary (Automatic): Approx. 630 hours
	LTE	Stationary (Automatic): Approx. 640 hours
Continuous call time *3, 4	FOMA/3G	Approx. 660 min.
	GSM	Approx. 600 min.
	VoLTE (Voice call)	Approx. 530 min.
Continuous 1Seg watching time *5		Approx. 590 min.
Charging time *6		AC Adapter 05 : Approx. 150 min. DC Adapter 04 : Approx. 150 min.

Display	Type	IPS
	Size	Approx. 5.0 inch
	Number of colors	16777216 colors
	Resolution	720 (H)×1280 (V) pixels (HD)
Image pickup device	Type	Out-camera : Backside-illumination layered CMOS In-camera : Back-illuminated CMOS
	Size	Out-camera : 1/3.0 inch In-camera : 1/5.0 inch
Number of effective pixels		Out-camera : Approx. 13.1 million pixels In-camera : Approx. 5.0 million pixels
Number of recording pixels (Max.)		Out-camera : Approx. 12.8 million pixels In-camera : Approx. 5.0 million pixels
Digital zoom	Still image	Out-camera : Up to approx. 6.0 x (80 levels)
	Videos	Out-camera : Up to approx. 6.0 x (80 levels)

Still picture recording size		Out-camera : 13M maximum pixels 4128 × 3096 9M wide 4128×2336 3M 2048 × 1536 FullHD 1920 × 1080 Mobile email 640×480 In-camera: 5M 2592×1944 3.7M 2592×1458 3M 2048 × 1536 FullHD 1920 × 1080 Mobile email 640×480
Video recording size		Out-camera : FullHD 1920×1080 Fit screen 1280 × 720 Mobile email 640×480 In-camera: FullHD 1920×1080 Fit screen 1280 × 720 Mobile email 640×480
Wireless LAN		IEEE802.11a/b/g/n compatible*7
Bluetooth	Version	4.1*8
	Output	power class 1
	Supported profile*9	HFP (1.6), HSP (1.2), DUN (1.1), OPP (1.2), SPP (1.2), HID (1.0), A2DP (1.2)*10, AVRCP (1.5), PBAP (1.2), PAN (1.0)*11, HDP (1.0), ANP (1.0), FMP (1.0), PASP (1.0), PXP (1.0), TIP (1.0), HOGP (1.0)

Earphone/microphone jack	∅3.5 mm earphone jack, tetrapolar
Display language	Japanese/English
Input language (Character entry)	Japanese/English/Korean/Chinese
Input language (Voice input)	Subjected to Google voice search function

- *1 It is not the actual storage capacity because the memory is also used for the Android OS and preinstalled applications. For available memory, see "Storage". (→P139)
- *2 Continuous stand-by time indicates the estimated stand-by time when radio signal reception is normal. Stationary continuous stand-by time indicates the estimated average operation time when radio signal reception is normal. Due to internal battery charging condition, function settings, operating environment such as ambient temperature, radio wave conditions in the area of use (the radio waves are weak or absent), etc. stand-by time may be reduced to about half.
- *3 Activating applications also reduces call (communication)/stand-by time even if you do not call or use the Internet.
- *4 Continuous call time indicates the estimated time that the phone can send or receive radio waves normally.
- *5 Continuous ISeg watching time indicates the estimated watching time when radio signal reception is normal.
- *6 Charging time indicates the estimated time for firstly charging an empty internal battery with the terminal turned OFF for approximately 10 minutes, and then charging with the terminal turned ON. When the temperature is high or low, it takes a long time for charging.
- *7 2.4 GHz/5 GHz are supported for IEEE 802.11n.

- *8 It is confirmed that the terminal and all Bluetooth devices are compliant with Bluetooth standards designated by Bluetooth SIG, and they are authenticated. However, procedures may differ or data transfer may not be possible depending on the device's characteristics or specifications.
- *9 These are created by standardizing connection procedures for Bluetooth communications according to individual product properties.
- *10 The terminal supports aptX and SBC audio codecs.
- *11 The terminal supports PAN-NAP and PANU.

■ Internal battery

Battery used	Li-ion battery
Nominal voltage	3.8V
Nominal capacity	2580 mAh

❖ File formats of still images and videos taken by the terminal

Type	File format	Extension
Still images	JPEG	.jpg
Videos	MP4	.mp4

❖ Recording time of video (Estimation)

Shooting Size	Maximum recording time per one item
FullHD 1920×1080	Approx. 36 min.

❖ Available files for the terminal

You can create, view and edit (save) the following files using the "Word", "Excel", and "PowerPoint" applications in the terminal.

Type/Extension	Create	View	Edit (Save)
Document file (Word)	.doc	×	○
	.docx	○	○
Spreadsheet file (Excel)	.xls	×	○
	.xlsx	○	○
Presentation file (PowerPoint)	.ppt	×	○
	.pptx	○	○

Specific Absorption Rate (SAR) of Mobile Phones

This model F-05J mobile phone complies with Japanese technical regulations and international guidelines regarding exposure to radio waves.

This mobile phone was designed in observance of Japanese technical regulations regarding exposure to radio waves^{*1} and limits to exposure to radio waves recommended by a set of equivalent international guidelines. This set of international guidelines was set out by the International Commission on Non-ionizing Radiation Protection (ICNIRP), which is in collaboration with the World Health Organization (WHO), and the permissible limits include a substantial safety margin designed to assure the safety of all persons, regardless of age and health condition.

The technical regulations and international guidelines set out limits for radio waves as the Specific Absorption Rate, or SAR, which is the value of absorbed energy in any 10 grams of tissue over a 6-minute period. The SAR limit for mobile phones is 2.0 W/kg. The highest SAR value for this mobile phone when tested for use near the head is 1.082 W/kg^{*2} and when worn on the body is 0.361 W/kg^{*3}. There may be slight differences between the SAR levels for each product, but they all satisfy the limit.

The actual SAR of this mobile phone while operating can be well below that indicated above. This is due to automatic changes to the power level of the device to ensure it only uses the minimum required to reach the network. Therefore in general, the closer you are to a base station, the lower the power output of the device.

This mobile phone can be used in positions other than against your head. Please keep the mobile phone farther than 1.5 cm away from your body by using such as a carrying case or a wearable accessory without including any metals. This mobile phone satisfies the technical regulations and international guidelines.

The World Health Organization has stated that "a large number of studies have been performed over the last two decades to assess whether mobile phones pose a potential health risk. To date, no adverse health effects have been established as being caused by mobile phone use."

Please refer to the WHO website if you would like more detailed information.

http://www.who.int/docstore/peh-emf/publications/facts_press/fact_english.htm

Please refer to the websites listed below if you would like more detailed information regarding SAR.

Ministry of Internal Affairs and Communications Website:
<http://www.tele.soumu.go.jp/e/sys/ele/index.htm>

Association of Radio Industries and Businesses Website:
<http://www.arib-emf.org/01denpa/denpa02-02.html> (in Japanese only)

NTT DOCOMO, INC. Website:
<https://www.nttdocomo.co.jp/english/product/sar/>

FUJITSU LIMITED Website:
<http://www.fmworld.net/product/phone/sar/> (in Japanese only)

^{*1} Technical regulations are defined by the Ministerial Ordinance Related to Radio Law (Article 14-2 of Radio Equipment Regulations).

^{*2} Including other radio systems that can be simultaneously used with LTE/FOMA.

- *3 Including other radio systems that can be simultaneously used with LTE/FOMA.

◆ Declaration of Conformity

Trade Mark: Fujitsu

Model Name: F-05J

Hereby, Fujitsu Connected Technologies Ltd. declares that the RE product of "F-05J" is in compliance with RED 2014/53/EU.

The full text of the EU DoC is available at the following internet address:

<https://www.fmworld.net/product/phone/doc/> (in Japanese only)

This mobile phone complies with the EU requirements for exposure to radio waves. Your mobile phone is a radio transmitter, designed and manufactured not to exceed the SAR^{*1} limits^{*2} for exposure to radio-frequency (RF) energy, which SAR^{*1} value, when tested for compliance against the standard was 0.656W/kg^{*3} for HEAD and 1.196 W/kg^{*3} for BODY. While there may be differences between the SAR^{*1} levels of various phones and at various positions, they all meet^{*4} the EU requirements for RF exposure.

- *1 The exposure standard for mobile phones employs a unit of measurement known as the Specific Absorption Rate, or SAR.
- *2 The SAR limit for mobile phones used by the public is 2.0 watts/kilogram (W/kg) averaged over ten grams of tissue, recommended by The Council of the European Union. The limit incorporates a substantial margin of safety to

give additional protection for the public and to account for any variations in measurements.

- *3 Including other radio systems that can be simultaneously used with cellular radio wave.
- *4 Tests for SAR have been conducted using standard operation positions with the phone transmitting at its highest certified power level in all tested frequency bands. Although the SAR is determined at the highest certified power level, the actual SAR level of the phone while operating can be well below the maximum value. This is because the phone is designed to operate at multiple power levels so as to use only the power required to reach the network. In general, the closer you are to a base station antenna, the lower the power output.

Radio type/Description		Transmitter Frequency	Maximum Output Power
GSM	GSM900	880-915MHz	33.5dBm
	DCS1800	1710-1785MHz	30dBm
UMTS	FDD I	1920-1980MHz	24.5dBm
LTE	FDD 1	1920-1980MHz	23.8dBm
	FDD 3	1710-1785MHz	23.5dBm
WLAN 2.4GHz	IEEE 802.11b	2400-2483.5MHz	15dBm
	IEEE 802.11g	2400-2483.5MHz	14.5dBm
	IEEE 802.11n	2400-2483.5MHz	14.5dBm
WLAN 5GHz	IEEE 802.11a	5150-5350MHz	16dBm
		5470-5725MHz	15.5dBm
	IEEE 802.11n	5150-5350MHz	16.5dBm
		5470-5725MHz	16.5dBm
Bluetooth	Bluetooth	2400-2483.5MHz	10.5dBm

Radio type/Description		Transmitter Frequency	Maximum Output Power
RFID	NFC	13.56MHz	-10dB μ A/m at 10m

The manufacturer of this product is Fujitsu Connected Technologies Ltd. with its registered place of business at 1-1, Kamikodanaka 4-chome, Nakahara-ku, Kawasaki, Kanagawa 211-8588, Japan.

◆ Federal Communications Commission (FCC) Notice

- This device complies with part 15 of the FCC rules. Operation is subject to the following two conditions :
 - ① this device may not cause harmful interference, and
 - ② this device must accept any interference received, including interference that may cause undesired operation.
- Changes or modifications made in or to the radio phone, not expressly approved by the manufacturer, will void the user's authority to operate the equipment.
- The device complies with 15.205 of the FCC Rules.

◆ FCC RF Exposure Information

This model phone meets the U.S. Government's requirements for exposure to radio waves.

This model phone contains a radio transmitter and receiver. This model phone is designed and manufactured not to exceed the emission limits for exposure to radio frequency (RF) energy as set by the FCC of the U.S. Government. These limits are part of comprehensive guidelines and establish permitted levels of RF energy for the general population. The guidelines are based on standards that were developed by independent scientific organizations through periodic and thorough evaluation of scientific studies.

The exposure standard for wireless mobile phones employs a unit of measurement known as the Specific Absorption Rate (SAR). The SAR limit set by the FCC is 1.6 W/kg. Tests for SAR are conducted using standard operating positions as accepted by the FCC with the phone transmitting at its highest certified power level in all tested frequency bands. Although the SAR is determined at the highest certified power level, the actual SAR level of the phone while operating can be well below the maximum value. This is because the phone is designed to operate at multiple power levels so as to use only the power required to reach the network. In general, the closer you are to a wireless base station antenna, the lower the power output level of the phone.

Before a phone model is available for sale to the public, it must be tested and certified to prove to the FCC that it does not exceed the limit established by the U.S. government-adopted requirement for safe exposure. The tests are performed on position and locations (for example, at the ear and worn on the body) as required by FCC for each model. The highest SAR value for this model phone as reported to the FCC, when tested for use at the ear, is 0.98 W/kg*, and when worn on the body,

is 0.83 W/kg*. (Body-worn measurements differ among phone models, depending upon available accessories and FCC requirements).

While there may be differences between the SAR levels of various phones and at various positions, they all meet the U.S. government requirements. The FCC has granted an Equipment Authorization for this model phone with all reported SAR levels evaluated as in compliance with the FCC RF exposure guidelines. SAR information on this model phone is on file with the FCC and can be found under the Equipment Authorization Search section at <http://www.fcc.gov/oet/ea/fcdid/> (please search on FCC ID VQK-F05J).

For body worn operation, this phone has been tested and meets the FCC RF exposure guidelines.

Please use an accessory designated for this product or an accessory which contains no metal and which positions the handset a minimum of 1.0 cm from the body.

- In the United States, the SAR limit for wireless mobile phones used by the general public is 1.6 Watts/kg (W/kg), averaged over one gram of tissue. SAR values may vary depending upon national reporting requirements and the network band.

* Including other radio systems that can be simultaneously used with cellular radio wave.

This equipment has been tested and found to comply with the limits for a Class B digital device, pursuant to part 15 of the FCC Rules.

These limits are designed to provide reasonable protection against harmful interference in a residential installation. This equipment generates, uses and can radiate radio frequency energy and, if not installed and used in accordance with the instructions, may cause harmful interference to radio

communications. However, there is no guarantee that interference will not occur in a particular installation. If this equipment does cause harmful interference to radio or television reception, which can be determined by turning the equipment off and on, the user is encouraged to try to correct the interference by one or more of the following measures:

- Reorient or relocate the receiving antenna.
- Increase the separation between the equipment and receiver.
- Connect the equipment into an outlet on a circuit different from that to which the receiver is connected.
- Consult the dealer or an experienced radio/TV technician for help.

◆ Important Safety Information

AIRCRAFT

Switch off your wireless device when boarding an aircraft or whenever you are instructed to do so by airline staff. If your device offers flight mode or similar feature consult airline staff as to whether it can be used on board.

DRIVING

Full attention should be given to driving at all times and local laws and regulations restricting the use of wireless devices while driving must be observed.

HOSPITALS

Mobile phones should be switched off wherever you are requested to do so in hospitals, clinics or health care facilities. These requests are designed to prevent possible interference with sensitive medical equipment.

PETROL STATIONS

Obey all posted signs with respect to the use of wireless devices or other radio equipment in locations with flammable material and chemicals. Switch off your wireless device whenever you are instructed to do so by authorized staff.

INTERFERENCE

Care must be taken when using the phone in close proximity to personal medical devices, such as pacemakers and hearing aids.

Pacemakers

Pacemaker manufacturers recommend that a minimum separation of 15 cm be maintained between a mobile phone and a pace maker to avoid potential interference with the pacemaker. To achieve this use the phone on the opposite ear to your pacemaker and does not carry it in a breast pocket.

Hearing Aids

Some digital wireless phones may interfere with some hearing aids. In the event of such interference, you may want to consult your hearing aid manufacturer to discuss alternatives.

For other Medical Devices :

Please consult your physician and the device manufacturer to determine if operation of your phone may interfere with the operation of your medical device.

Warning

This device have been tested to comply with the Sound Pressure Level requirement laid down in the applicable EN 50332-1 and/or EN 50332-2 standards. Permanent hearing loss may occur if earphones or headphones are used at high volume for prolonged periods of time.

<Prevention of Hearing Loss>

Warning statement requirement under EN 60950-1:A12.



Warning: To prevent possible hearing damage, do not listen to high volume levels for long periods.

Export Administration Regulations

This product and its accessories may be under coverage of the Export Administration Regulations of Japan ("Foreign Exchange and Foreign Trade Control Laws" and the related laws and regulations). And, they may be also under coverage of Export Administration Regulations of the U.S. When exporting and reexporting this product and its accessories, take necessary procedures on your responsibility and expense. For details, contact Ministry of Economy, Trade and Industry of Japan or US Department of Commerce.

Intellectual Property Right

◆ Copyrights and portrait rights

Except for the case protected by copyright laws such as personal use, use of terminal to reproduce, alter, or publicly transmit recorded pictures or sounds, or copyrighted text, images, music or software downloaded from websites without the copyright holder's authorization is prohibited. Note that taking photos or recordings at some demonstrations, performances or exhibitions may be prohibited even when only for personal use. Avoid taking pictures of others with the terminal without their consent or disclosing recorded pictures of others without their consent to general public through Internet websites etc., because they may infringe on portrait rights.

◆ Trademarks

- "FOMA", "i-mode", "i-α ppli", "ToruCa", "mopera U", "WORLD CALL", "WORLD WING", "iD", "sp-mode", "Xi", "dTV", "LIVE UX", logo of "ToruCa", logo of "OsaiFu-Keitai", logo of "iD", logo of "Area Mail", logo of "dmenu", logo of "dmarket", logo of "Instruction Manual", logo of "Anshin Scan", logo of "Hanashite Hon'yaku", logo of "docomo mail", logo of "Data Copy", logo of "docomo phonebook", logo of "Schedule", logo of "Memo", and logo of "My Magazine" are trademarks or registered trademarks of NTT DOCOMO, INC.
- "Catch Phone (Call waiting service)" is a registered trademark of Nippon Telegraph and Telephone Corporation.
- Rovi, G-GUIDE, G-GUIDE MOBILE and G-Guide related logos are trademarks or registered trademarks of Rovi Corporation and/or its subsidiaries in Japan.
- "ATOK" is a registered trademark of JustSystems Corporation in Japan and other countries. "ATOK" is a copyrighted work of JustSystems Corporation and other rights are those of JustSystems Corporation and respective owners.
-  is a registered trademark of FeliCa Networks, Inc.
- FeliCa is a registered trademark of Sony Corporation.
- QR code is a registered trademark of Denso Wave Inc.
- Twitter and Twitter logo are trademarks or registered trademarks of Twitter, Inc.
- LINE and LINE logo are trademarks of LINE Corporation.
- Facebook and Facebook logo are trademarks or registered trademarks of Facebook, INC.
- microSD logo, microSDHC logo and microSDXC logo are trademarks of SD-3C, LLC.



- Google, Android, Google Play and other marks are trademarks of Google Inc.
- The Bluetooth® and logos are owned by the Bluetooth SIG, INC. and any use of such marks by NTT DOCOMO, INC. is under license. Other trademarks and names are those of their respective owners.
- Qualcomm® aptX™ audio is a product of Qualcomm Technologies International, Ltd. Qualcomm is a trademark of Qualcomm Incorporated, registered in the United States, and other countries, used with permission. aptX is a trademark of Qualcomm Technologies International, Ltd., registered in the United States and other countries, used with permission.
- "UD新丸コ (UD Shin Maru Go)" is provided by Morisawa Inc. and the copyrights of its font data belong to them.
- Wi-Fi, logo of Wi-Fi, Wi-Fi Alliance, WMM, Wi-Fi CERTIFIED, logo of Wi-Fi CERTIFIED, WPA, WPA2, Wi-Fi Protected Setup, Wi-Fi Direct and Miracast are trademarks or registered trademarks of Wi-Fi Alliance.
- AOSS™ is a trademark of BUFFALO INC. 
- EPSON is a registered trademark of Seiko Epson Corporation.
- Adobe Mobile Print and Scan SDK is used for some part of the terminal.
©2013-2017 Adobe Systems Incorporated. All rights reserved.
- iWnn© OMRON SOFTWARE Co., Ltd. 2008-2017 All Rights Reserved.



- Microsoft, Windows, Microsoft Excel, Microsoft PowerPoint, OneNote and OneDrive are trademarks or registered trademarks of Microsoft Corporation in the United States and other countries.
- Microsoft Word is a product name of Microsoft Corporation in the United States.
- Other company and product names mentioned in this manual are trademarks or registered trademarks of their respective holders.
- All other trademarks are those of their respective owners.

◆ Others

- Part of this product includes module developed by Independent JPEG Group.
- FeliCa is a contactless IC card technology developed by Sony Corporation.
- This product is licensed based on MPEG-4 Visual Patent Portfolio License. The use of MPEG-4 Video Codec function is allowed for personal and nonprofit use only in the cases below.
 - Recording moving pictures and i-motion that conform to MPEG-4 Visual Standard (hereinafter referred to as MPEG-4 Video)
 - Playing MPEG-4 Videos recorded personally by consumers not engaged in profit activities
 - Playing MPEG-4 Video supplied from the provider licensed from MPEG-LA
For further utilizing such as promotion, in-house use or profit-making business, please contact MPEG LA, LLC in U.S.
- This product is licensed under the AVC patent portfolio license for the personal and noncommercial use of a consumer to (i) encode video in compliance with the AVC standard (henceforth referred to as AVC video) and/or (ii) decode AVC video that was encoded by a consumer engaged in a personal and noncommercial activity and/or was obtained from a video provider licensed to provide AVC video. No license is granted or shall be implied for any other use. Additional information may be obtained from MPEG LA, L.L.C.
See <http://www.mpegla.com>

◆ Open source software

- Software licensed under Apache License V2.0 and necessarily modified by us is used for this product.
- This product contains open source software complying with GNU General Public License (GPL), GNU Lesser General Public License (LGPL), etc.
For details on the software license, from the Home screen, →[Settings]→[System]→[About phone]→[Legal information]→See [Open source licenses].
For software source codes disclosed based on the open source licenses, refer to the following website. For details, refer the website below.
<http://spf.fmworld.net/fujitsu/c/develop/sp/android/> (In Japanese only)

SIM unlock

This terminal supports SIM unlock. If you release SIM lock, you can use SIM by a carrier other than NTT DOCOMO.

- Available services and functions may be limited. DOCOMO is not liable to any failures or malfunctions.
- For details of SIM unlock procedure, refer to NTT DOCOMO website.

- 1** Install a SIM card of other manufacturers.
- 2** Turn the terminal ON
- 3** Enter SIM unlock code
- 4** [Unlock]

✓INFORMATION

- To check the SIM unlock status, from the Home screen,  → [Settings] → [System] → [About phone] → [Status] → [SIM lock status].

Index

A

About phone	161	Canceling sync	154
Auth	161	Manual synchronization	154
Legal information	161	Removing.....	154
Status.....	161	Setting	154
Access point	131	After-Sales Service	185
Adding	131	Airplane mode	128
Checking	131	Android Beam	167
Initializing	132	Anshin Enkaku Support	184
Accessibility	161	APN	131
Accessibility shortcut	161	App battery check	139
Captions	161	App running time	139
Click after pointer stops moving	161	Application list	60
Color correction.....	161	Disabling applications	64
Color inversion	161	Managing.....	64
Display size	161	Sorting	64
Font size	161	Uninstalling	64
High contrast text	161	Application lock	148
Key misoperation support	161	Application permissions	40
Large mouse pointer.....	161	Application pinning	152
Magnification gestures	161	Apps	138
Mono audio.....	161	CLEAR CACHE	138
Osusume hint.....	161	CLEAR DATA	138
Speak passwords.....	161	Deleting.....	138
Text-to-speech output	161	DISABLE	138
Touch & hold delay	161	UNINSTALL	138
Accounts	154	Area Mail	86
Adding.....	154	Beep tone.....	87
		Check screen image and beep tone.....	87
		Deleting.....	87
		Displaying	87
		Receive setting	87
		Receiving	86
		Settings	87
		Automatic still image shooting	105

C

Calculator	118
Call forwarding service	73
Call notification	73
Call waiting	73
Caller ID display request service	73
Camera	102
Automatic still image shooting.....	105
Automatic video recording.....	108
Cautions on shooting.....	102
Continuous shooting.....	104
Panorama shooting.....	105
Shooting settings for still image.....	106
Shooting settings for video.....	108
Still image shooting.....	104
Switch to in-camera/out-camera.....	104
Video shooting.....	107
Capture & Draw	55
Cellular networks	131
Character entry	41
Common phrase utility.....	46
Dictionary utility.....	46
Editing text.....	46
Keyboard.....	41
Setting.....	45
Voice input.....	42
Charging	35
AC adapter.....	36
Charging adapter.....	36
PC.....	36
Precautions.....	35
Child proof	57
Clearing credentials	148

Clock	116
Alarm.....	116
Stopwatch.....	117
Timer.....	117
World clock.....	116
Customize screen	56

D

Data roaming	173
Data usage	127
Billing cycle.....	128
Cellular data.....	128
Date	160
Date & time	160
Automatic date & time.....	160
Automatic time zone.....	160
Select time zone.....	160
Set date.....	160
Set time.....	160
Use 24-hour format.....	160
Decline call	69
Default alarm ringtone	136
Default notification ringtone	136
Device administrators	143
Dial pad tones	136
Display	29
Switching the portrait/landscape view.....	39
Display size	133
Display & Wallpaper	133
dmarket	92
dmenu	92
Do not disturb	136
docomo Data Copy	119
Backing up to/Restoring from microSD card.....	120

Gmail	82	Notification icon	50
Displaying	82	Slide display icon	49
Google	155	Status bar	50
Google Maps	115	Status icon	51
Google Play	92	iD application	96
Google Search	118	In-camera	29
GPS antenna section	29	Indicator LED	29, 49
H		Information of Home app	66
Handwritten input	41	Initial settings	47
Hiding recently used applications	151	Install certificates	147
Highlight & Copy	55	Intellectual Property Right	198
Home screen	58	Intelligent color adjust	133
Adding	60	Internal storage	162
Back to apps list	59	International call (WORLD CALL)	69
Back up and restore	65	International roaming (WORLD WING)	172
Create folder	58	International dial assist	176
Customizing	58	Network service	176
Deleting	60	Internet call	74
Disabling applications	59	J	
Home screens	60	Jump to Camera	141
Kisekae	59	K	
Removing applications/widgets from the Home screen	59	Kazashite-Link compatible service	94, 95
Setting Machi-Chara	59	Keep lit when held	134
Wallpaper	59	Key misoperation support	161
Homescreen selector	57	Keyboard	41
I		External keyboard	47
Icon	49	Handwritten input	41
Back icon	49	Numeric keypad	41
History icon	49	QWERTY keypad	41
Home icon	49		
Navigation bar	49		

L

Languages & input	155
Launcher setting	158
Light	29
Location data/GPS	113
Location Setting	114
Lock screen	54
LTE antenna section	29

M

Mail	80, 82, 83
Make passwords visible	143
Manner mode	137
Manner mode	137
Manner mode (Alarm)	137
Manner mode (Silent)	137
Original manner	137
Maps	115
Material	16
Media Player	111
Play list	112
Playing music/video	111
Purchasing from dmarket	112
Memory	140
Messaging	80
Microphone	29
microSD card	33, 162
Erasing data	139
Format	139
Installing	34
Operation from a PC	169
Removing	34
Transfer files	169

Transfer photos (PTP)	169
microSD card slot	30
microSD password	145
Miracast	171
Mouthpiece	29
Multi-connection	125
My Magazine	65
My physical profile	141
My profile	79

N

Navigation bar	49
Network Mode	174
Network operators	174
Network security code	144
Network service	73
NFC communication	167
NFC/Osaifu-Keitai Lock	96
Canceling	96
Notification icon	50
Notification panel	52
Notifications	135
Notifying caller ID	67, 73
Nuisance call blocking service	73
Numeric keypad	41, 43
Flick input	43
Gesture input	43
Numeric keypad input	43
2-touch input	44
NX! Mail	83
Account settings	85
Backing up/Restoring	86
Creating/Sending	83
Deleting	84

Forwarding.....	84	ON/OFF.....	73
General settings.....	85	Phone memo list.....	73
Mail account setup.....	83	Recording.....	69
Operations on the folder list screen.....	84	Settings.....	73
Receiving/Displaying.....	84	Phone ringtone.....	136
Replying.....	84	Phonebook.....	76
Replying all.....	84	Deleting.....	77
Settings.....	85	Editing.....	77
O		Exporting.....	78
Open source software.....	200	Favorites.....	78
Osaifu-Keitai.....	94	Importing.....	78
Lock Setting.....	96	Index.....	77
Precautions on using.....	94	My profile.....	79
Osaifu-Keitai service.....	94	Phonebook list.....	76
Out-camera.....	29, 102	Profile screen.....	78
P		Registering group.....	78
Pan.....	38	Registration.....	77
Panel switch.....	53	Search.....	77
Password manager.....	147	Using Group.....	77
Pedometer.....	159	Physical keyboard.....	155
Personal dictionary.....	155	Picture correction.....	133
Phone.....	67	PIN code.....	144
Add wait.....	67	Changing.....	152
Add 2-sec pause.....	67	Input.....	152
Call settings.....	73	Setting.....	152
Call volume.....	70	Pinch.....	39
Caller ID notification.....	67, 73	Play Store.....	92
Emergency call.....	68	Deleting application.....	93
Making a call.....	67	Installing application.....	93
Receiving a call.....	69	Playing video.....	110
Select prefix.....	67	Pointer speed.....	155
Phone memo.....	73	Power key.....	30
		Pre-installed applications.....	61
		Print.....	169

Set up SIM card lock	152	Deleting	81
Setting international roaming	176	Displaying	81
Setting menu	122	Forwarding	81
Shake to unrotate	134	Receiving	81
Shooting setting for videos		Replying	81
Exposure/WB	109	Sending	80
Shooting settings for still image	106	Setting	82
Camera Mode	106	Software Update	187
Display grid	107	Sound	136
Exposure/WB	107	Sound at start charging	136
Flash	106	Speaker	29
HDR mode	107	Specifications	190
Location	107	Spell checker	155
Picture Size	106	Split screen	56
Save	107	Status bar	50
SelfTimer	107	Status icon	51
Touch shutter	107	Stereo earphone jack	29
Shooting settings for video	108	Still image shooting screen	103
Camera Mode	108	Stopping the packet communication	131
Light	108	Storage	139, 162
Movie Size	108	Internal shared storage	139
Saving location	108	SD card	139
SIM unlock	201	Storage type	147
Sleep	134	Strap hole	29
Sleep mode	53	Super ATOK ULTIAS settings	45
Slide	38	Conversion setting	45
Slide display	50, 159	Design	45
Slide spot	54	Handwritten input	45
Slide-in function	54, 158	Initialize	46
Slide-in launcher	54	Numeric keypad	45
Slot cap	29	Open source software license	46
Smart Lock	146	Operation sound/vibrate	45
SMS	80	QWERTY keypad	45
Creating	80	Set selection list	45

Super ATOK ULTIAS	46
ULTIAS Feature select	45
Utility	46
Swipe	38
Switching input method	44
T	
Tap	38
Tap & pay	95
Task manager	56
Tethering	129
Bluetooth tethering	130
Easy settings	130
USB tethering	129
Wi-Fi tethering	129
Text-to-speech output	155, 161
Time	160
ToruCa	97
Touch and hold	38
Touch panel	29
Notes	38
Using	38
Touch sounds	136
Touch-tone signals	70
Trademarks	198
Troubleshooting	178
Trusted credentials	147
Turn off sound when flipped	136, 141
Turning power off	37
Turning power on	37
TV	97
Activating	99
Channel setting	102
Display subtitles	102

End	99
Link	100
Reserving watching	100
Setting	101
Signal	98
Sound output	102
Subtitle language	102
Subtitle position	102
Using 1Seg	97

U

Unknown sources	151
Unlocking PIN lock	152
USB tethering	129
Useful tools	158
Users	140
Using overseas	172
After returning to Japan	177
Checking	173
Communication services	172
Making a call in the country you stay	175
Receiving a call in the country you stay	175
Settings	173

V

Vibrate on tap	136
Vibrate when ringing	136
Video call	
Making a call	67
Receiving a call	69
Video correction	133
Video shooting screen	103
Viewing still image	110
Voice adjusting	70

Voice input.....	42
Voice Search.....	119
Setting	156
Voice slowing	70
Voicemail service	73
Volume key.....	30
Volumes	136
VPN.....	130
Adding	130
Connecting	130
Disconnecting	131
VPN (Virtual Private Network).....	130

W

Warranty	185
Waterproofness/Dustproofness, shock resistance	23
Wi-Fi	123
Adding	124
Advanced settings	127
Configuring	127
Connecting	123
Deleting	124
Easy Settings	124
Scanning	124
Wi-Fi Auto ON/OFF	126
Wi-Fi sleep policy	127
Wi-Fi antenna section	29
Wi-Fi Direct	125
Wi-Fi Easy Settings	124
AOSS system	124
WPS system	124
Wi-Fi tethering.....	129
WORLD CALL.....	69
WORLD WING.....	172

Numeric

1Seg	97
1Seg antenna	29, 98
1Seg watching screen	99

Use mobile phone with your manners!

Remember to be courteous to others when you use your terminal.

Always turn OFF your terminal in cases below

- In a place where use of mobile phone is prohibited
Follow the instructions of each airline or medical facility for the use of mobile phones on their premises. Power off the terminal in a place where the use is prohibited.

Always set Public mode in cases below

- When driving
There is a penalty for holding or using the terminal while driving. However, absolutely necessary cases such as rescue of a sick person and maintaining public safety are exempted.
- In public places such as a theater, movie theater or art museum
Using the terminal in quiet public places will likely bother other people.

Match the volume of voice and ring alert to your location

- In a quiet place like a restaurant or hotel lobby, pay attention to the volume of your voice etc. when using the terminal.
- In town areas, while using the terminal, be sure not to block foot or car traffic.

Consider privacy

- Please be considerate of the privacy of individuals around you when taking and sending photos using camera-equipped mobile phones.

Do not use smartphone while walking

- Use of smartphone while walking on station platform or road makes your eyesight extremely narrow. It may cause accident.
- Stop and stay in a safe place and then use smartphone.

Functions designed for public use

Your terminal has a number of useful functions designed for public use, such as a setting that instructs your terminal not to answer incoming calls and the ability to set the terminal for silent operation.

- **Public mode (Power OFF)→P73**

The caller hears an announcement notifying that the receiver is in a place requiring power-off of mobile phone, and the call is disconnected.

- **Vibrate→P136**

Vibrates when there is an incoming call.

- **Manner mode→P137**

Eliminates all sounds the terminal makes, such as ring alert and keypad/touch sound (Shutter sound cannot be eliminated).

And you can use optional services such as Voicemail service, Call forwarding service, etc. →P73



モバイルリサイクルネットワーク
MOBILE RECYCLING NETWORK

We collect old phones, etc. regardless of brands and manufacturers. Bring them to your nearest docomo Shop.

*Items to be collected: mobile phones, PHS, battery packs, chargers, desktop holders (regardless of brands and manufacturers)

Online Procedures, Confirmation of Subscription, etc.

From the terminal dメニュー (dmenu)→"My docomo (お客様サポート) (My docomo (Customer support))"→"ドコモオンライン手続き (docomo online procedures)"

From PCs My docomo (<https://www.nttdocomo.co.jp/mydocomo/>) →Select required item in "ドコモオンライン手続き (docomo online procedures)"

- There are cases where the site may not be available depending on system maintenance or subscription, etc.
- You need "Network security code" and "ID/Password of d ACCOUNT" to follow the procedure for "ドコモオンライン手続き (docomo online procedures)".

■ From DOCOMO mobile phones

 -81-3-6832-6600 (toll free)

(To enter "+", touch and hold the "0" key)

- * You can use international call access codes instead of "+" to call.

■ From land-line phones

 -81-3-6832-6600 (toll)

- * You are charged a call fee to Japan.
- * For international call access codes, refer to NTT DOCOMO website.

Business hours: 24 hours (open all year round)

- Please confirm the phone number before you dial.
- If you lose your terminal or have it stolen, immediately take the steps necessary for suspending the use of the terminal.
- If the terminal you purchased is damaged, bring your terminal to a repair counter specified by DOCOMO after returning to Japan.

Technical Inquiries & Repairs

0120-005-250 (toll free)

* Service available in: English, Portuguese, Chinese, Spanish
* Unavailable from part of IP phones.

(Business hours : 9:00 a.m. to 8:00 p.m.)

■ From DOCOMO mobile phones (In Japanese only)

(No prefix) 151 (toll free)

* Unavailable from land-line phones, etc.

■ From land-line phones (In Japanese only)

0120-800-000 (toll free)

* Unavailable from part of IP phones.

(Business hours : 9:00 a.m. to 8:00 p.m. (open all year round))

● Please confirm the phone number before you dial.

● For Applications or Repairs and After-Sales Service, please contact the above-mentioned information center or the docomo Shop etc. near you on the NTT DOCOMO website.

NTT DOCOMO website <https://www.nttdocomo.co.jp/english/>

■ From DOCOMO mobile phones (In Japanese only)

(No prefix) 113 (toll free)

* Unavailable from land-line phones, etc.

■ From land-line phones (In Japanese only)

0120-800-000 (toll free)

* Unavailable from part of IP phones.

(Business hours : 24 hours (open all year round))



Li-ion 00

Don't forget your mobile phone ... or your manners!

When using your mobile phone in a public place, don't forget to show common courtesy and consideration for others around you.



危険です、
歩きスマホ。



キケン!
水ぬれ充電

Sales: NTT DOCOMO, INC.

Manufacturer: FUJITSU CONNECTED TECHNOLOGIES LIMITED

2017.5 (1st Edition)

CA92002-9513