

DRWIN / DATE:	AM01
CHK'D / DATE:	FLORENCE AER01+
APP'D / DATE:	POWER MANAGEMENT
DRWIN NO.:	GSM3508 V3.3
SHEET:	1
OF:	12
	3

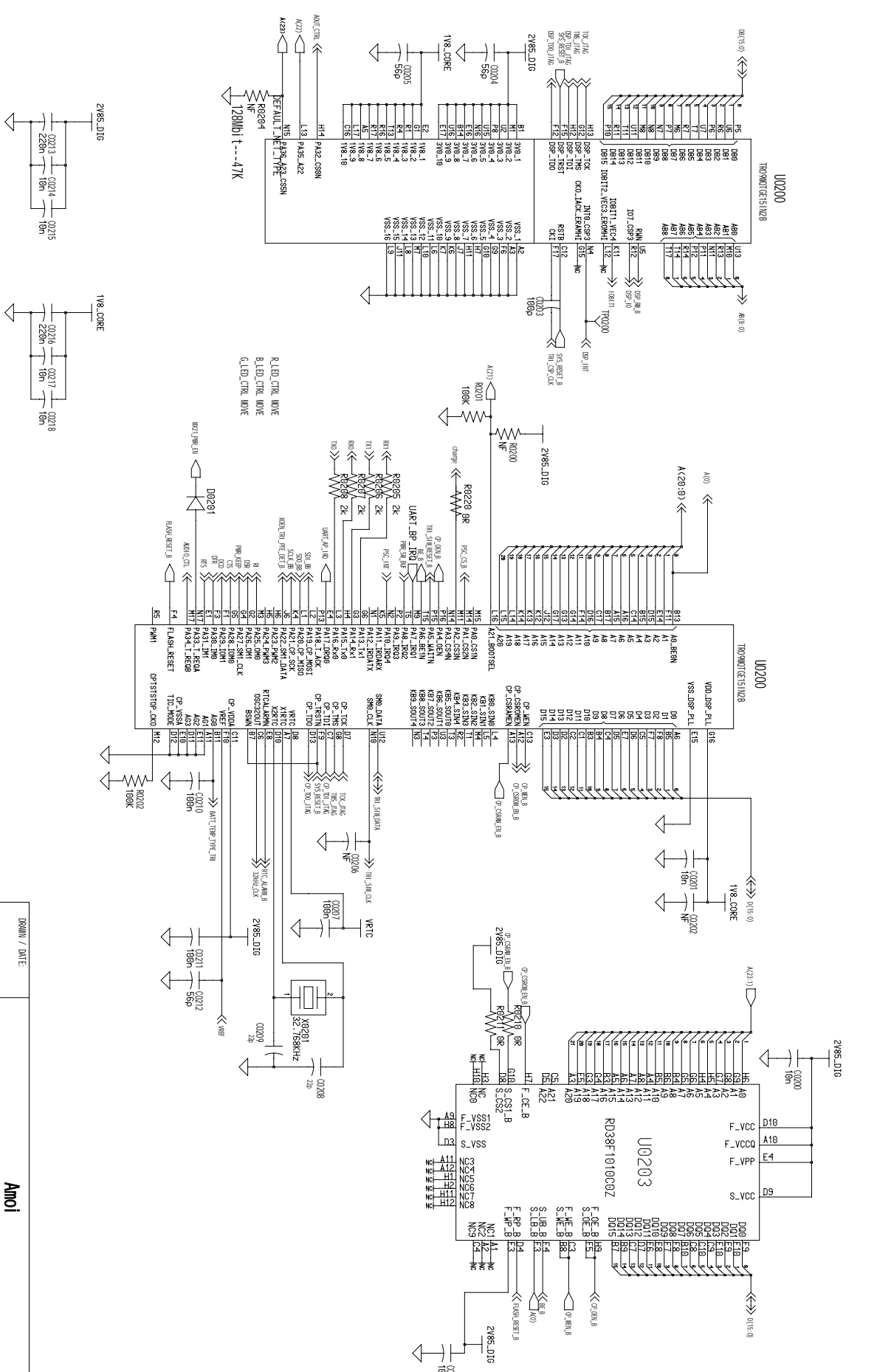

DRWNN / DATE:	
CHK'D / DATE:	
APP'D / DATE:	
Anoi	
FLORENCE AER01+	
DIGITAL BASEBAND	
DRWNN NO.:	GSM3508 V3.3

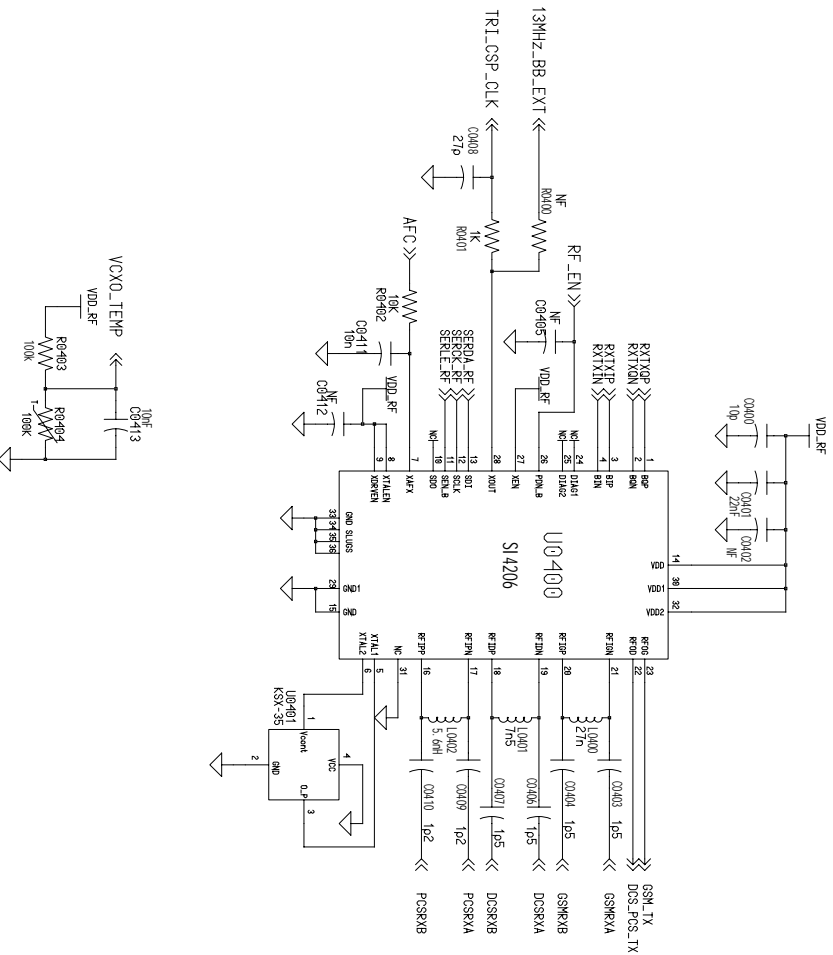

DRWIN / DATE:	GJP 24/7/03	TITLE:	FLORENCE AER01+ RF
DRWIN NO.:	GSM3508 V3.3	SHEET:	4 A
APP'D / DATE:		OF	12 3

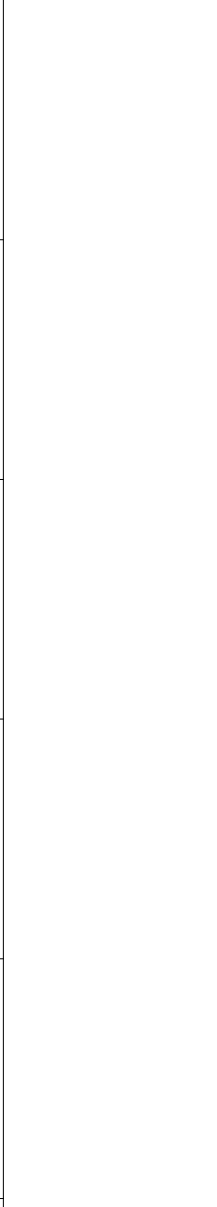
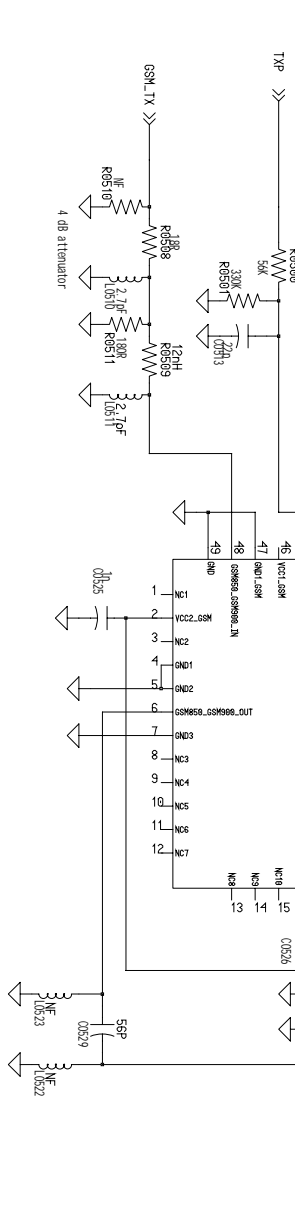
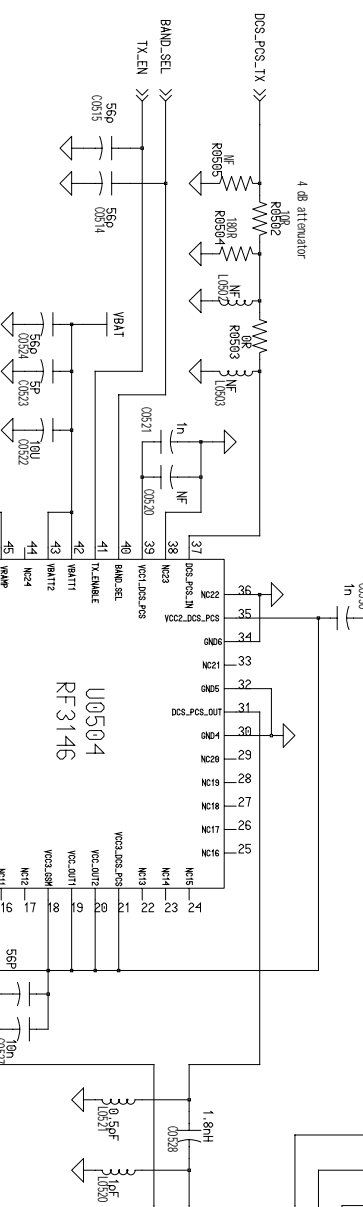
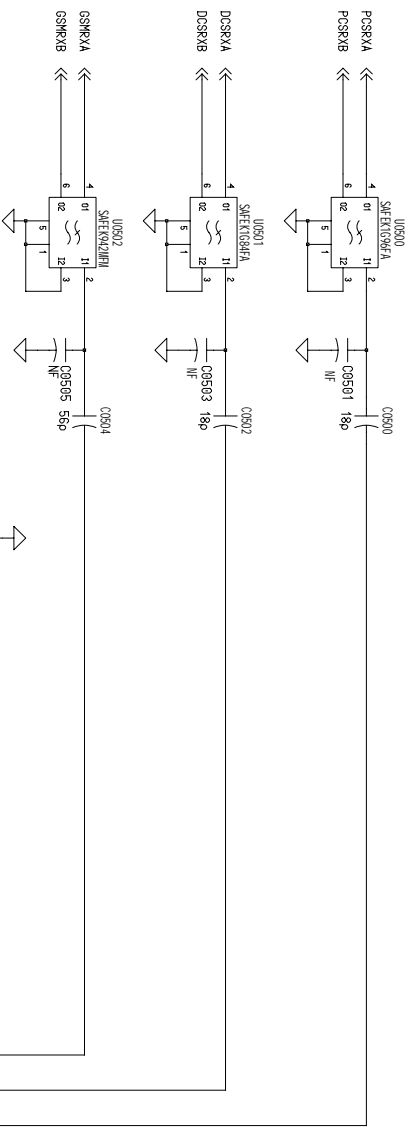

DRAWN / DATE: CJP 20/6/03	TITLE: FLORENCE AER01+ <small>RF CORE</small>
APP'D / DATE: 	DRAWING NO: GSM3508 V3.3
AM01	
SHEET: 5 A OF 12 3	

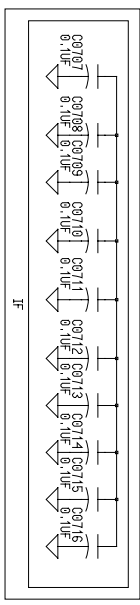
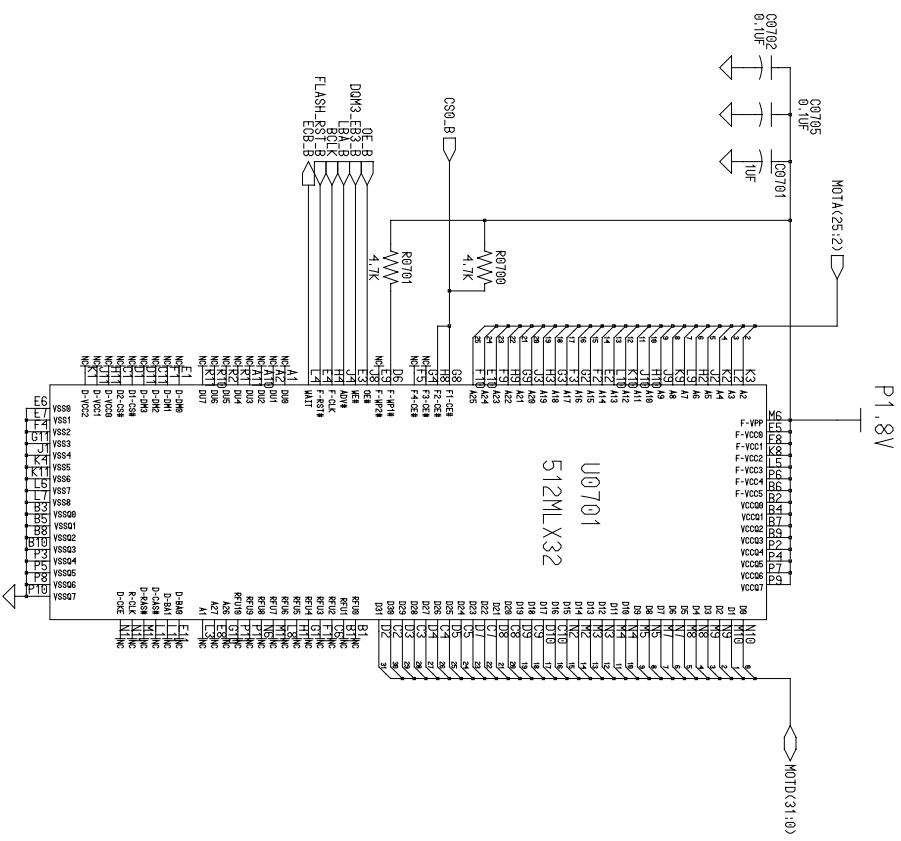

DRAWN / DATE: CJP 25/7/03	TITLE: FLORENCE AER01+ FLASH
APP'D / DATE: 	DRAWING NO: GSM3508 V3.3
Annoi	
SHEET: 7 A OF 12 3	

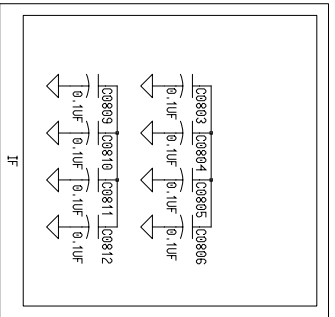
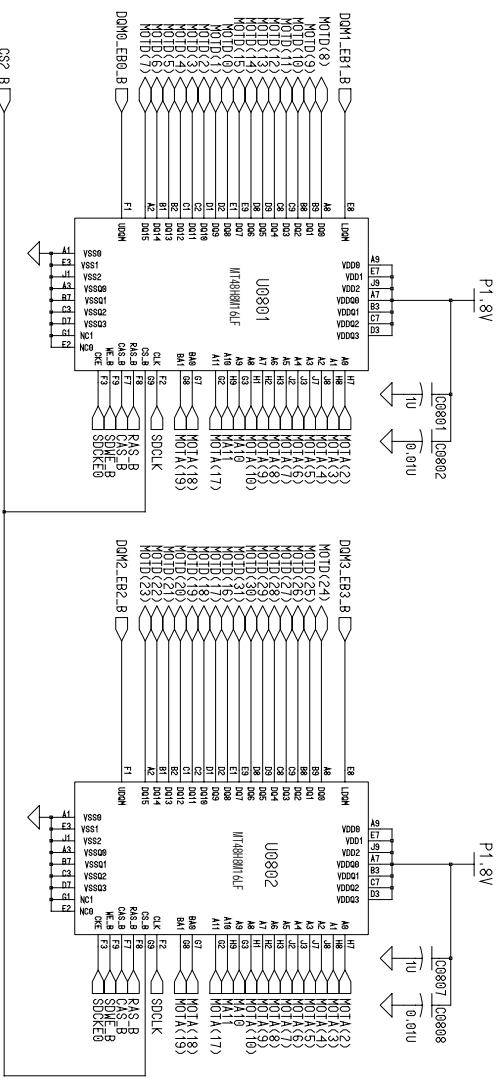

DRAWING / DATE: GP 25/7/03	TITLE: FLORENCE AER01 + <small>ST001</small>
APP'D / DATE: _____	DRAWING NO. NO.: GSM3508 V3.3
8 12	A 3

