

Features of LG-TM250

1. Wave Type

- CELLULAR : G7W
- PCS : G7W

2. Frequency Scope

Transmit Frequency (MHz)		Receive Frequency (MHz)		
CELLULAR	PCS	CELLULAR	PCS	GPS
824.82 ~ 848.19	1850~1910	869.82~893.19	1930~1990	1575.42

3. Rated Output Power : CELLULAR = 0.20W
PCS = 0.20W

4. Output Conversion Method : This is possible by correcting the key board channel.

5. Voltage and Current Value of Termination Part Amplifier (Catalogue included)

MODE	Part Name	Voltage	Current	Power
CELLULAR	CX77105	4.0V	600mA	0.20W
PCS	CX77107	4.0V	700mA	0.20W

6. Functions of Major Semi-Conductors

Classification	Function
MSM6050-FBGA	Terminal operation control and digital signal processing
MCP (TH50VPF5585ADSB)	Flash Memory (32Mbit) + SRAM (32Mbit) Storing of terminal operation program
RFR6000	Converts Rx RF signal to baseband signal
RFT6100	Converts baseband signal to Tx RF signal

7. Frequency Stability

- CELLULAR : ± 0.5 PPM
- PCS : ± 0.1 PPM



**CDMA Mobile Subscriber Unit
LG-TM250**

SERVICE MANUAL

**Tri-Band, Tri-Mode
[PCS/GPS/Cellular]
CDMA Mobile Phone**

Table of Contents

General Introduction
 4

CHAPTER 1. System Introduction

1. System Introduction.....4
 2. Features and Advantages of CDMA Mobile Phone6
 3. Structure and Functions of Tri-band CDMA Mobile Phone9
 4. Specification.....10
 5. Installation 18

CHAPTER 2. NAM Input Method

1. NAM Program Method and Telephone Number Inputting Method 20

CHAPTER 3. Circuit Description

1. RF Transmit/Receive Part.....24
 2. Digital/Voice Processing Part.....29

CHAPTER 4. Trouble Shooting.....38

CHAPTER 5. Safety.....44

CHAPTER 6. Glossary.....47

CHAPTER 7. How to Download.....??

APPENDIX.....60

General Introduction

The LG-TM250 phone has been designed to operate on the latest digital mobile communication technology, Code Division Multiple Access (CDMA). This CDMA digital technology has greatly enhanced voice clarity and can provide a variety of advanced features. Currently, CDMA mobile communication technology has been commercially used in Cellular and Personal Communication Service (PCS). The difference between them is the operating frequency spectrum. Cellular uses 800Mhz and PCS uses 1.9Ghz. The LG-TM250 support GPS Mode, we usually call it tri-band phone.

The CDMA technology adopts DSSS (Direct Sequence Spread Spectrum). This feature of DSSS enables the phone to keep communication from being crossed and to use one frequency channel by multiple users in the same specific area, resulting that it increases the capacity 10 times more compared with that in the analog mode currently used. Soft/Softer Handoff, Hard Handoff, and Dynamic RF power Control technologies are combined into this phone to reduce the call being interrupted in a middle of talking over the phone.

Cellular and PCS CDMA network consists of MSO (Mobile Switching Office), BSC (Base Station Controller), BTS (Base station Transmission System), and MS (Mobile Station). The following table lists some major CDMA Standards.

CDMA Standard	Designator	Description
Basic air interface	TIA/EIA/IS-95-A/B/C	Protocol between MS and BTS for Cellular
	ANSI J-STD-008	Protocol between MS and BTS for PCS
Network	TIA/EIA/IS-634	MAS-BS
	TIA/EIA/IS/651	PCSC-RS
	TIA/EIA/IS-41-C	Intersystem operations
	TIA/EIA/IS-124	Nom-signaling data comm.
Service	TIA/EIA/IS-96-B	Speech CODEC
	TIA/EIA/IS-99	Assign data and fax
	TIA/EIA/IS-637	Short message service
	TIA/EIA/IS-657	Packet data
Performance	TIA/EIA/IS-97	Cellular base station
	TIA/EIA/IS-98	Cellular mobile station
	ANSI J-STD-018	PCS personal station
	ANSI J-STD-019	PCS base station
	TIA/EIA/IS-125	Speech CODEC

* TSB -74: Protocol between an IS-95A system and ANSI J-STD-008

1. System Introduction

1.1 CDMA Abstract

The CDMA mobile communication system has a channel hand-off function that is used for collecting the information on the locations and movements of mobile telephones from the cell site by automatically controlling several cell site through the setup of data transmission routes, and then enabling one switching system to carry out the automatic remote adjustment. This is to maintain continuously the call state through the automatic location confirmation and automatic radio channel conversion when the busy subscriber moves from the service area of one cell site to that of another by using automatic location confirmation and automatic radio channel conversion functions. The call state can be maintained continuously by the information exchange between switching systems when the busy subscriber moves from one cellular system area to the other cellular system area.

In the cellular system, the cell site is a small-sized low output type and utilizes a frequency allocation system that considers mutual interference, in an effort to enable the re-use of corresponding frequency from a cell site separated more than a certain distance.

Unlike the time division multiple access (TDMA) or frequency division multiple access (FDMA) used in the band limited environment, the Code Division Multiple Access (CDMA) system which is one of digital cellular systems is a multi-access technology under the interference limited environment. It can process more number of subscribers compared to other systems (TDMA system has the processing capacity three times greater than the existing FDMA system whereas CDMA system, about 12~15 times of that of the existing system).

CDMA system can be explained as follows; TDMA or CDMA can be used to enable each person to talk alternately or provide a separate room for each person when two persons desire to talk with each other at the same time, whereas FDMA can be used to enable one person to talk in soprano, whereas the other in bass (one of the two talkers can carry out synchronization for hearing in case there is a bandpass filter function in the area of the hearer). Another available method is to make two persons to sing in different languages at the same time, space, and frequency when wishing to let the audience hear the singing without being confused. This is the characteristic of CDMA.

On the other hand, when employing the CDMA technology, each signal has a different pseudo-random binary sequence used to spread the spectrum of carrier. A great number of CDMA signals share the same frequency spectrum. In the perspective of frequency area or time area, several CDMA signals are overlapped. Among these types of signals, only desired signal energy is selected and received through the use of pre-determined binary sequence; desired signals can be separated, and then received with the correlator used for recovering the spectrum into its original state. At this time, the spectrums of other signals that have different codes are not recovered into its original state, and appears as the self-interference of the system.

2. Features and Advantages of CDMA Mobile Phone

2.1 Various Types of Diversities

When employing the narrow band modulation (30kHz band) that is the same as the analog FM modulation system used in the existing cellular system, the multi-paths of radio waves create a serious fading. However, in the CDMA broadband modulation (1.25MHz band), three types of diversities (time, frequency, and space) are used to reduce serious fading problems generated from radio channels in order to obtain high-quality calls.

Time diversity can be obtained through the use of code interleaving and error correction code whereas frequency diversity can be obtained by spreading signal energy to wider frequency band. The fading related to normal frequency can affect the normal 200~300kHz among signal bands and accordingly, serious effect can be avoided. Moreover, space diversity (also called path diversity) can be realized with the following three types of methods. First, it can be obtained by the duplication of cell site receive antenna. Second, it can be obtained through the use of multi-signal processing device that receives a transmit signal having each different transmission delay time and then, combines them. Third, it can be obtained through the multiple cell site connection (Soft Handoff) that connects the mobile station with more than two cell sites at the same time.

2.2 Power Control

The CDMA system utilizes the forward (from a base station to mobile stations) and backward (from the mobile station to the base station) power control in order to increase the call processing capacity and obtain high-quality calls. In case the originating signals of mobile stations are received by the cell site in the minimum call quality level (signal to interference) through the use of transmit power control on all the mobile stations, the system capacity can be maximized. If the signal power of mobile station is received too strong, the performance of that mobile station is improved. However, because of this, the interference on other mobile stations using the same channel is increased and accordingly, the call quality of other subscribers is reduced unless the maximum accommodation capacity is reduced.

In the CDMA system, forward power control, backward open loop power control, and closed loop power control methods are used. The forward power control is carried out in the cell site to reduce the transmit power on mobile stations less affected by the multi-path fading and shadow phenomenon and the interference of other cell sites when the mobile station is not engaged in the call or is relatively nearer to the corresponding cell site. This is also used to provide additional power to mobile stations having high call error rates, located in bad reception areas or far away from the cell site.

The backward open loop power control is carried out in a corresponding mobile station; the mobile station measures power received from the cell site and then, reversely increases/decreases transmit power in order to compensate channel changes caused by the forward link path loss and terrain characteristics in relation to the mobile station in the cell site. By doing so, all the mobile transmit signals received by the base station have same strength.

Moreover, the backward closed loop power control used by the mobile station is performed to control power using the commands issued out by the cell site. The cell site receives the signal of each corresponding mobile station and compares this with the pre-set threshold value and then, issues out power increase/decrease commands to the corresponding mobile station every 1.25msec (800 times per second). By doing so, the gain tolerance and the different radio propagation loss on the forward/backward link are complemented.

2.3 Voice Encoder and Variable Data Speed

The bi-directional voice service having variable data speed provides voice communication which employs voice encoder algorithm having power variable data rate between the base station and the mobile station. On the other hand, the transmit voice encoder performs voice sampling and then, creates encoded voice packets to be sent out to the receive voice encoder, whereas the receive voice encoder demodulates the received voice packets into voice samples.

One of the two voice encoders described in the above is selected for use depending on inputted automatic conditions and message/data; both of them utilize four-stage frames of 9600, 4800, 2400, and 1200 bits per second for cellular and 14400,7200,3600,1800 bits per second for PCS, so PCS provide relatively better voice quality (almost twice better than the existing cellular system). In addition, this type of variable voice encoder utilizes adaptive threshold values on selecting required data rate. It is adjusted in accordance with the size of background noise and the data rate is increased to high rate only when the voice of caller is inputted.

Therefore, background noise is suppressed and high-quality voice transmission is possible under the environment experiencing serious noise. In addition, in case the caller does not talk, data transmission rate is reduced so that the transmission is carried out in low energy. This will reduce the interference on other CDMA signals and as a result, improve system performance (capacity increased by about two times).

2.4 Protecting Call Confidentiality

Voice privacy is provided in the CDMA system by means of the private long code mask used for PN spreading. Voice privacy can be applied on the traffic channels only. All calls are initiated using the public long code mask for PN spreading. The mobile station user may request voice privacy during call setup using the origination message or page response message, and during traffic channel operation using the long code transition request order.

The Transition to private long code mask will not be performed if authentication is not performed. To initiate a transition to the private or public long code mask, either the base station or the mobile station sends a long code transition request order on the traffic channel.

2.5 Soft Handoff

A handoff in which the mobile station commences communications with a new base station without interrupting communications with the old base station. Soft handoff can only be used between CDMA channels having identical frequency assignments.

2.6 Frequency Re-Use and Sector Segmentation

Unlike the existing analog cellular system, the CDMA system can reuse the same frequency at the adjacent cell. there is no need to prepare a separate frequency plan. Total interference generated on mobile station signals

received from the cell site is the sum of interference generated from other mobile stations in the same cell site and interference generated from the mobile station of adjacent cell site. That is, each mobile station signal generates interference in relation to the signals of all the other mobile stations.

Total interference from all the adjacent cell sites is the ratio of interference from all the cell sites versus total interference from other mobile stations in the same cell site (about 65%). In the case of directional cell site, one cell normally uses a 120 ° sector antenna in order to divide the sector into three. In this case, each antenna is used only for 1/3 of mobile stations in the cell site and accordingly, interference is reduced by 1/3 on the average and the capacity that can be supported by the entire system is increased by three times.

2.7 Soft Capacity

The subscriber capacity of the CDMA system is flexible depending on the relation between the number of users and service classes. For example, the system operator can increase the number of channels available for use during the busy hour despite the drop in call quality. This type of function requires 40% of normal call channels in the standby mode during the handoff, in an effort to avoid call disconnection resulting from the lack of channels.

In addition, in the CDMA system, services and service charges are classified further into different classes so that more transmit power can be allocated to high class service users for easier call set-up; they can also be given higher priority of using hand-off function than the general users.

3. Structure and Functions of tri-band CDMA Mobile Phone

The hardware structure of CDMA mobile phone is made up of radio frequency (RF) part and logic part. The RF part is composed of Receiver part (Rx), Transmitter part (Tx) and Local part (LO). For the purpose of operating on tri-band, It is necessary dual Tx path, tri Rx path, dual PLL and switching system for band selection. The mobile phone antenna is connected with the frequency separator which divide antenna input/output signals between cellular frequency band (824~894 Mhz) and PCS frequency band (1850~1990Mhz). Each separated path is linked with the cellular duplexer and PCS duplexer. Duplexer carries out separating Rx band and Tx band. The Rx signals from the antenna are converted into baseband frequency by the frequency synthesizer and frequency down converter. And then, passive SAW filter which is a band pass filter for removing Tx interferer frequency. The baseband signals is converted into digital signals via Analog-to-Digital Converter (ADC). In front of the ADC, switching system is required to choose which band path should be open. The digital signals send to 5 correlators in each CDMA de-modulator. Of these, one is called a searcher whereas the remaining 4 are called data receivers (fingers). Digitalized IF signals include a great number of call signals that have been sent out by the adjacent cells. These signals are detected with pseudo-noise sequence (PN Sequence). Signal to interference ratio (C/I) on signals that match the desired PN sequence are increased through this type of correlation detection process, but other signals obtain processing gain by not increasing the ratio. The carrier wave of pilot channel from the cell site most adjacently located is demodulated in order to obtain the sequence of encoded data symbols. During the operation with one cell site, the searcher searches out multi-paths in accordance with terrain and building reflections. On three data receivers, the most powerful 3 paths are allocated for the parallel tracing and receiving. Fading resistance can be improved a great deal by obtaining the diversity combined output for de-modulation. Moreover, the searcher can be used to determine the most powerful path from the cell sites even during the soft handoff between the two cell sites. Moreover, 3 data receivers are allocated in order to carry out the de-modulation of these paths. Output data that has been demodulated changes the data string in the combined data row as in the case of original signals(deinterleaving), and then, are demodulated by the forward error correction decoder which uses the Viterbi algorithm.

Mobile station user information send out from the mobile station to the cell site pass through the digital voice encoder via a mike. Then, they are encoded and forward errors are corrected through the use of convolution encoder. Then, the order of code rows is changed in accordance with a certain regulation in order to remove any errors in the interleaver. Symbols made through the above process are spread after being loaded onto PN carrier waves. At this time, PN sequence is selected by each address designated in each call.

Signals that have been code spread as above are digital modulated (QPSK) and then, power controlled at the automatic gain control amplifier (AGC Amp). Then, they are converted into RF band by the frequency synthesizer synchronizing these signals to proper output frequencies.

Transmit signals obtained pass through the duplexer filter and then, are sent out to the cell site via the antenna.

4. Specification

4.1 General Specification

4.1.1 Transmit/Receive Frequency Interval :

- 1) CELLULAR : 45 MHz
- 2) PCS : 80 MHz

4.1.2 Number of Channels (Channel Bandwidth)

- 1) CELLULAR : 20 Channels
- 2) PCS : 48 Channels

4.1.3 Operating Voltage : DC 3.2~4.1V

4.1.4 Battery Power Consumption : DC 3.7V

	SLEEP	IDLE	MAX POWER
CELLULAR	0.8 mA	100~120mA	650 mA (24 dBm)
PCS	0.8 mA	110~130 mA	750 mA (24 dBm)

4.1.5 Operating Temperature : -30°C ~ +60°C

4.1.6 Frequency Stability

- 1) CDMA : ± 0.5 PPM
- 2) PCS : ± 0.1 PPM

4.1.7 Antenna : Stubby Type (Helical&Meander), 50 Ω

4.1.8 Size and Weight

- 1) Size : 80 * 44 * 22.8 mm
- 2) Weight : 88 g (Approximately with standard battery)

4.1.9 Channel Spacing

- 1) CELLULAR : 1.25MHz
- 2) PCS: 1.25 MHz

4.1.10 Battery Type, Capacity and Operating Time.

Unit = Hours : Minutes

	Standard (950mAh)	
Standby Time	CELLULAR	About 170 Hours(SCI=1)
	PCS	About 170 Hours(SCI=1)
Talk time	CELLULAR	200 Minutes(+10dBm output)
	PCS	200 Minutes(+10dBm output)

4.2 Receive Specification

4.2.1 Frequency Range

- 1) CELLULAR : 869.820 MHz ~ 893.190 MHz
- 2) PCS : 1930 MHz ~ 1990 MHz
- 3) GPS : 1575.42 MHz

4.2.2 Local Oscillating Frequency Range :

- 1) CELLULAR : 1738.08 MHz ~ 1787.94 MHz
- 2) PCS : 1715.56 MHz ~ 1768.89 MHz
- 3) GPS : 3150.84 MHz

4.2.3 Sensitivity

- 1) CELLULAR : -104dBm (C/N 12dB or more)
- 2) PCS : -104dBm (C/N 12dB or more)
- 3) GPS : -148.5dBm

4.2.4 Selectivity

- 1) CELLULAR : 3dB C/N Degration (With Fch ± 1.25 kHz : -30dBm)
- 2) PCS : 3dB C/N Degration (With Fch ± 1.25 kHz : -30dBm)

4.2.5 Interference Rejection

- 1) Single Tone : -30dBm at 900 kHz (CELLULAR), -30dBm at 1.25MHz(PCS)
- 2) Two Tone : -43dBm at 900 kHz & 1700kHz(CELLULAR), -43dBm at 1.25 MHz & 2.05 MHz

4.2.6 Spurious Wave Suppression : Maximum of -80dB

4.2.7 CDMA Input Signal Range

- Dynamic area of more than -104~ -25 dB: 79dB at the 1.23MHz band.
- Transmit Band : below -60dBm
- Receive Band : below -80dBm

4.3 Transmit Specification

4.3.1 Frequency Range

- 1) CELLULAR : 824.820MHz ~ 848.190MHz
- 2) PCS : 1850 MHz ~ 1910 MHz

4.3.2 Output Power

- 1) CELLULAR : 0.224W
- 2) PCS: 0.224W

4.3.3 CDMA TX Frequency Deviation :

- 1) CELLULAR: ± 300 Hz or less
- 2) PCS: ± 150 Hz

4.3.4 CDMA TX Conducted Spurious Emissions

- 1) CELLULAR : 900kHz : - 42 dBc/30kHz below
1.98MHz : - 54 dBc/30kHz below
- 2) PCS : -42 dBc / 30KHz below

4.3.5 CDMA Minimum TX Power Control

- 1) CELLULAR : -50dBm below
- 2) PCS : -50dBm below

4.4 MS (Mobile Station) Transmitter Frequency

4.4.1 CELLULAR mode

Ch #	Center Freq. (MHz)	Ch #	Center Freq. (MHz)
1011	824.640	404	837.120
29	825.870	445	838.350
70	827.100	486	839.580
111	828.330	527	840.810
152	829.560	568	842.040
193	830.790	609	843.270
234	832.020	650	844.500
275	833.250	697	845.910
316	834.480	738	847.140
363	835.890	779	848.370

4.4.2 PCS mode

Ch #	Center Freq (MHz)	Ch #	Center Freq (MHz)	Ch #	Center Freq (MHz)
25	1851.25	425	1871.25	825	1891.25
50	1852.50	450	1872.50	850	1892.50
75	1853.75	475	1873.75	875	1893.75
100	1855.00	500	1875.00	900	1895.00
125	1856.25	525	1876.25	925	1896.25
150	1857.50	550	1877.50	950	1897.50
175	1858.75	575	1878.75	975	1898.75
200	1860.00	600	1880.00	1000	1900.00
225	1861.25	625	1881.25	1025	1901.25
250	1862.50	650	1882.50	1050	1902.50
275	1863.75	675	1883.75	1075	1903.75
300	1865.00	700	1885.00	1100	1905.00
325	1866.25	725	1886.25	1125	1906.25
350	1867.50	750	1887.50	1150	1907.50
375	1868.75	775	1888.75	1175	1908.75

4.5 MS (Mobile Station) Receiver Frequency

4.5.1 CELLULAR mode

Ch. #	Center Freq. (MHz)	Ch. #	Center Freq. (MHz)
1011	869.640	404	882.120
29	870.870	445	883.350
70	872.100	486	884.580
111	873.330	527	885.810
152	874.560	568	887.040
193	875.790	609	888.270
234	877.020	650	889.500
275	878.250	697	890.910
316	879.480	738	892.140
363	880.890	779	893.370

4.5.2 PCS mode

Ch #	Center Freq (MHz)	Ch #	Center Freq (MHz)	Ch #	Center Freq (MHz)
25	1931.25	425	1951.25	825	1971.25
50	1932.50	450	1952.50	850	1972.50
75	1933.75	475	1953.75	875	1973.75
100	1935.00	500	1955.00	900	1975.00
125	1936.25	525	1956.25	925	1976.25
150	1937.50	550	1957.50	950	1977.50
175	1938.75	575	1958.75	975	1978.75
200	1940.00	600	1960.00	1000	1980.00
225	1941.25	625	1961.25	1025	1981.25
250	1942.50	650	1962.50	1050	1982.50
275	1943.75	675	1963.75	1075	1983.75
300	1945.00	700	1965.00	1100	1985.00
325	1946.25	725	1966.25	1125	1986.25
350	1947.50	750	1967.50	1150	1987.50
375	1948.75	775	1968.75	1175	1988.75

4.5.3 GPS mode : 1575.42MHz

4.6 Desktop Charger : See Appendix

4.7 Travel Charger : See Appendix

4.8 Cigar Lighter Charger : See Appendix

4.9 Hands-Free Kit : See Appendix

5. Installation

5.1 Installing a Battery Pack

- 1) The Battery pack is keyed so it can only fit one way. Align the groove in the battery pack with the rail on the back of the phone until the battery pack rests flush with the back of the phone.
- 2) Slide the battery pack forward until you hear a “click”, which locks the battery in place.

CHAPTER 2. NAM Programming Method (Inputting of phone numbers included)

1. NAM Programming Method

1. Press 'menu' + 0 + "000000"

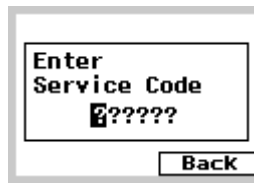
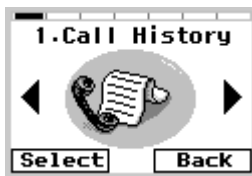

2. Press '1' or 'Soft Key 1' key for entering 'Service Prg.'



- Usually pressing 'Soft Key 1' will save the change.
- To exit Service Program, press 'END' key.

2-1) ESN

You can only see the ESN number.

Press 'Soft Key 1' to go next NAM 1 items.

Press 'Soft Key 2' to edit A-key.

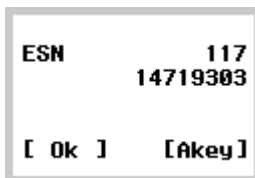

2-1-1) A-Key

You can edit the A-Key.

Press 'Soft Key 1' to save and go next NAM 1 items.

Press 'Soft Key 2' to go previous NAM 1 items.

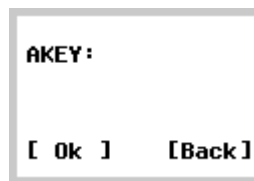
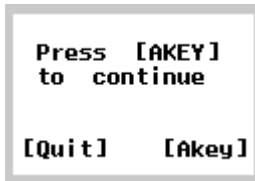

2-2) NAM 1 Mobile Directory Number

You can edit NAM1 Mobile Directory Number.
Press soft key 1 to save and go next NAM 1 items.
Press soft key 2 to go previous NAM 1 items.



2-3) NAM 1 Mobile Identification Number

You can edit NAM1 MIN.
Press soft key 1 to save and go next NAM 1 items.
Press soft key 2 to go previous NAM 1 items.

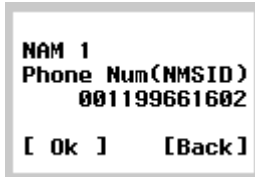

2-4) NAM 1 Home SID

You can edit NAM1 Home SID.
Press 'Soft Key 1' to save and go next NAM 1 items.
Press 'Soft Key 2' to go previous NAM 1 items.

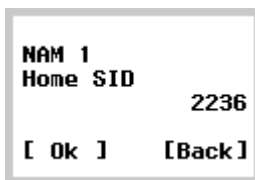

2-5) NAM 1 Name

You can edit NAM 1 Name.
Press 'Soft Key 1' to save and go next more NAM 1 items.
Press 'Soft Key 2' to go previous NAM 1 items.

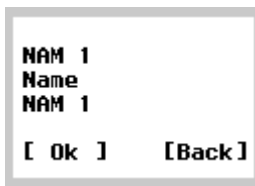

2-6) More NAM 1 Programming

You can decide to edit more NAM 1 items.

Press 'Soft Key 1' to exit basic Service Programming.

Press 'Soft Key 2' to edit more extended NAM 1 items.

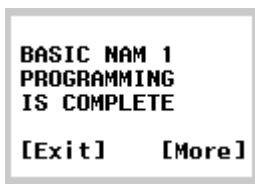

2-7) Security Code

You can edit Security Code.

Press 'Soft Key 1' to save and go next NAM 1 items.

Press 'Soft Key 2' to go previous NAM 1 items.

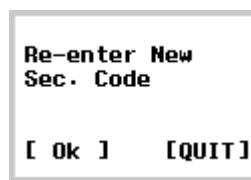
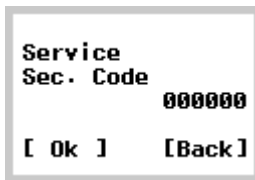

2-8) NAM 1 MCC

You can edit NAM 1 Mobile Country Code.

Press 'Soft Key 1' to save and go next NAM 1 items.

Press 'Soft Key 2' to go previous NAM 1 items.

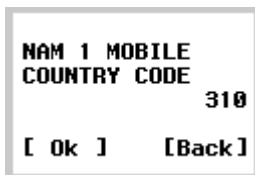

2-9) NAM 1 True IMSI MCC

You can edit NAM 1 True IMSI MCC.

Press 'Soft Key 1' to save and go next NAM 1 items.

Press 'Soft Key 2' to go previous NAM 1 items.

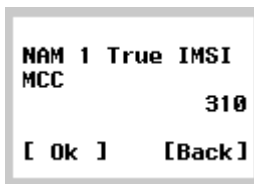

2-10) **NAM 1 True IMSI NMSID**

You can edit NAM 1 True IMSI NMSID.

Press 'Soft Key 1' to save and go next NAM 1 items.

Press 'Soft Key 2' to go previous NAM 1 items.



2-11) **NAM 1 PRL Enabled**

You can only see NAM 1 PRL Enabled.

Press 'Soft Key 1' to go next NAM 1 items.

Press 'Soft Key 2' to go previous NAM 1 items.

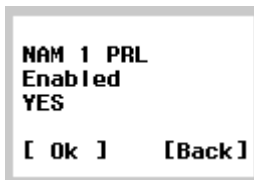

2-12) **NAM 1 CDMA Directory #**

You can edit NAM 1 CDMA Directory #.

Press 'Soft Key 1' to save and go next NAM 1 items.

Press 'Soft Key 2' to go previous NAM 1 items.

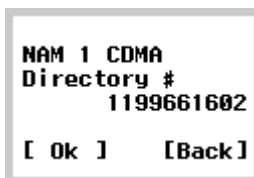

2-13) **NAM 1 CDMA Home SID/NID**

You can edit NAM 1 Home SID/NID Pairs.

Press 'Soft Key 1' to save and go next NAM 1 items.

Press 'Soft Key 2' to edit NAM 1CDMA Home SID and NID.

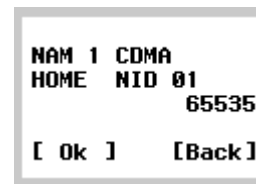
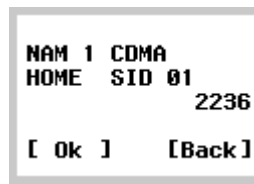
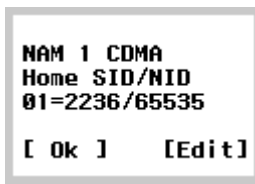

2-14) **NAM 1 CDMA Pri. CH A**

You can edit NAM 1 CDMA Primary Channel A.
Press 'Soft Key 1' to save and go next NAM 1 items.
Press 'Soft Key 2' to go previous NAM 1 items.

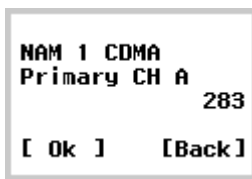

2-15) **NAM 1 CDMA Sec. CH A**

You can edit NAM 1 CDMA Secondary Channel A.
Press 'Soft Key 1' to save and go next NAM 1 items.
Press 'Soft Key 2' to go previous NAM 1 items.

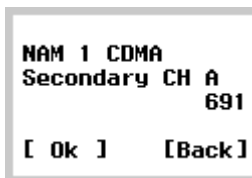

2-16) **NAM 1 CDMA Pri. CH B**

You can edit NAM 1 CDMA Primary Channel B.
Press 'Soft Key 1' to save and go next NAM 1 items.
Press 'Soft Key 2' to go previous NAM 1 items.

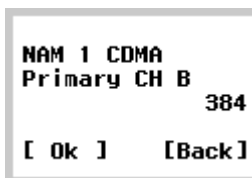

2-17) **NAM 1 CDMA Sec. CH B**

You can edit NAM 1 CDMA Secondary Channel B.
Press 'Soft Key 1' to save and go next NAM 1 items.
Press 'Soft Key 2' to go previous NAM 1 items.

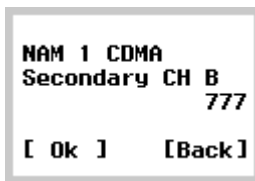

2-18) **NAM 1 Lockout SID/NID**

You can edit NAM 1 Lockout SID/NID Pairs.

Press 'Soft Key 1' to save and go next NAM 1 items.

Press 'Soft Key 2' to edit NAM 1 Lockout SID and NID.

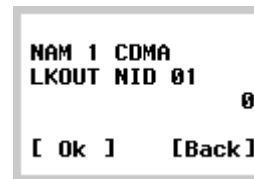
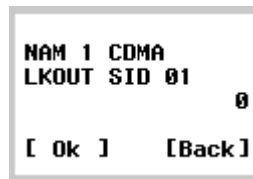
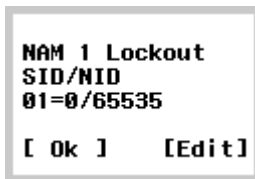

2-19) **NAM 1 Home Sys Reg**

You can edit NAM 1 Home System Registration.

Press 'Soft Key 1' to save and go next NAM 1 items.

Press 'Soft Key 2' to go previous NAM 1 items.

Press Up, Down key to choose YES/NO.

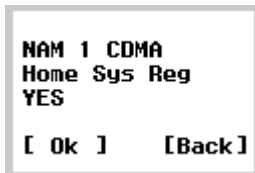

2-20) **NAM 1 Forn SID Reg**

You can edit NAM 1 Foreign SID Registration.

Press 'Soft Key 1' to save and go next NAM 1 items.

Press 'Soft Key 2' to go previous NAM 1 items.

Press Up, Down key to choose YES/NO.

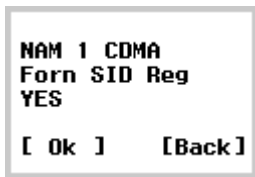

2-21) **NAM 1 Forn NID Reg**

You can edit NAM 1 Foreign NID Registration.
Press 'Soft Key 1' to save and go next NAM 1 items.
Press 'Soft Key 2' to go previous NAM 1 items.
Press Up, Down key to choose YES/NO.

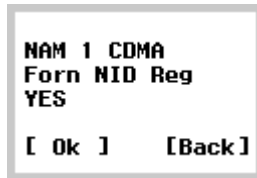

2-22) **NAM 1 Access Overload Class**

You can only see NAM 1 Access Overload Class.
Press 'Soft Key 1' to go next NAM 1 items.
Press 'Soft Key 2' to go previous NAM 1 items.

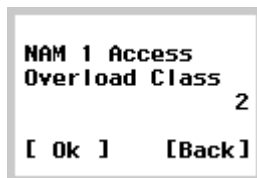

2-23) **NAM 2 Setting**

You can decide to edit NAM 2 items.
Press 'Soft Key 1' to skip NAM 2 items settings and go next items.
Press 'Soft Key 2' to edit NAM 2 related items.

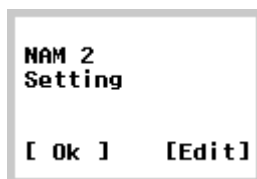

2-24) **Phone Model**

You can only see the Phone Model number.
Press 'Soft Key 1' to go next items.
Press 'Soft Key 2' to go previous items.

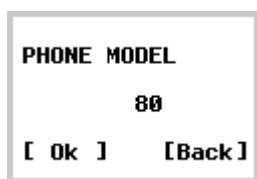

2-25) **Slot Cycle Index**

You can edit Slot Cycle Index

Press 'Soft Key 1' to save Slot Cycle Index and exit Service Programming.

Press 'Soft Key 2' to go previous items.



CHAPTER 3. Circuit Description

1. RF Transmit/Receive Part

1.1 Overview

The Tx and Rx part employs the Direct-Conversion system. The Tx and Rx frequencies are respectively 824.04~848.97 and 869.04~893.97 for cellular and 1850~1910 and 1930~1990 for PCS. The block diagram is shown in [Figure 1-1]. RF signals received through the antenna are separated by the SP3T switch.

RF Signal fed into the low noise amplifier (LNA) through the duplexer. Then, they are fed into RFR6000. In RFR6000, the IF signal is changed into baseband signal directly. Then, this signal is changed into digital signal by the analog to digital converter (ADC, A/D Converter), and the digital circuit part of the MSM(Mobile Station Modem) 6050 processes the data from ADC. The digital processing part is a demodulator.

In the case of transmission, RFT6100 receives OQPSK-modulated analog signal from the MSM6050.

The RFT6100 connects directly with MSM6050 using an analog baseband interface. In RFT6100, the baseband quadrature signals are upconverted to the Cellular or PCS frequency bands and amplified to provide signal drive capability to the power amp.

After that, the RF signal is amplified by the Power Amp in order to have enough power for radiation. Finally, the RF signal is sent out to the cell site via the antenna after going through the duplexer.

[Figure 1-1] Block Diagram of LG-TM250

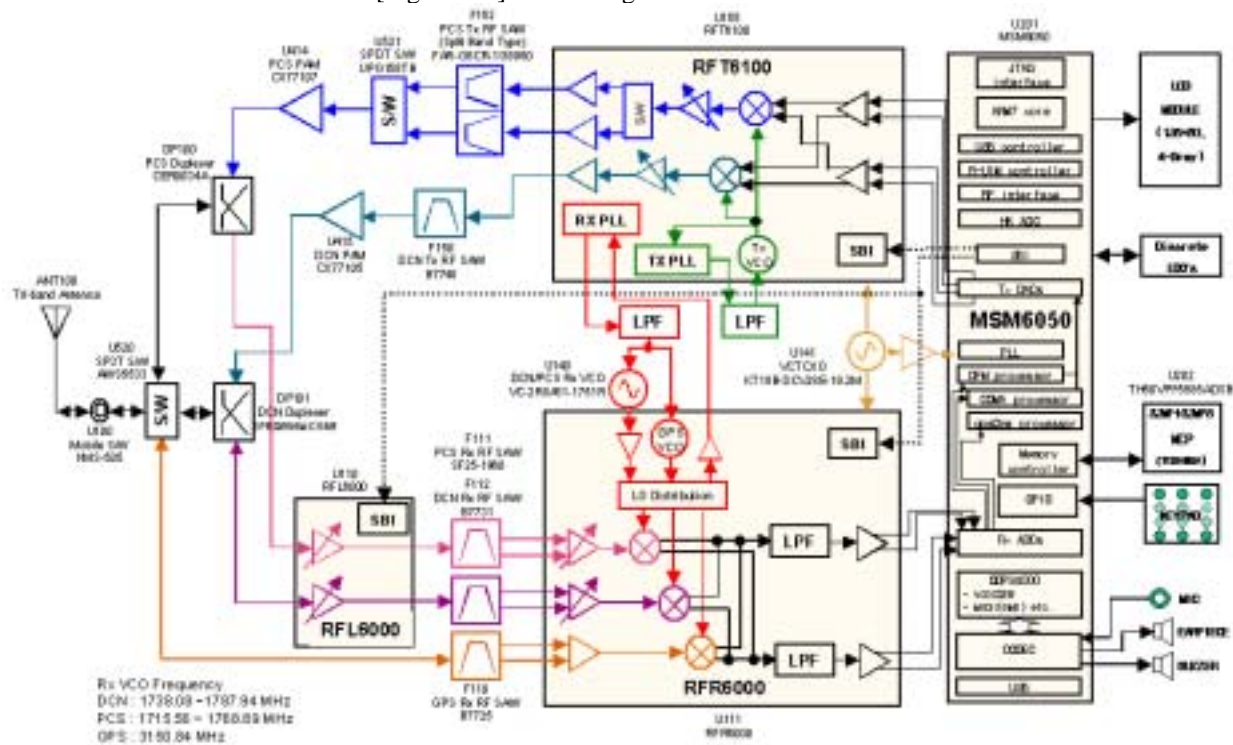

1.2 Description of Rx Part Circuit

1.2.1 SP3T switch(U520)

The main function of SP3T switch is to prohibit the other band signals from flowing into the one band circuit and vice versa. RF designer can use common tri-band antenna regardless of frequency band (800, 1575 and 1900 Mhz). The specification of LG-TM250 SP3T switch is described below:

	Cellular	GPS	PCS
Frequency Range	824 – 894 MHz	1575.42 MHz	1850 – 1990 MHz
Insertion Loss to Common	0.6dB Max (at +25 deg)	0.7 dB Max. (at +25 deg)	0.8dB Max (at +25 deg)
Isolation	25 dB Min.		
Return Loss	-15 dB Min.		
Power Capacity	10 W Max.		
Temperature Range	-30 to +85 deg		

1.2.2 Duplexers (DP100, DP101)

The duplexer consists of the Rx bandpass filter (BPF) and the Tx BPF which has the function of separating Tx and Rx signals in the full duplex system for using the common antenna. The Tx part BPF is used to suppress noises and spurious out of the Tx frequency band. The Rx BPF is used to receive only Rx signal coming from the antenna, which is usually called preselector. It's main function is to limit the bandwidth of spectrum reaching the LNA and mixer, attenuate receiver spurious response and suppress local oscillator energy. As a result frequency sensitivity and selectivity of mobile phone increase. The specification of LG-TM250 duplexer described below ;

- PCS duplexer

	Tx	Rx	Tx to Rx (min)
Pass Band	1850~1910 MHz	1930~1990 MHz	
Insertion Loss	3.2dB max	3.7dB max	
Return Loss	10dB min	10dB min	
Attenuation	45dB min (1930~1990MHz)	55dB min (1850~1910MHz)	55dB (1850~1910MHz) 46dB (1930~1990MHz)

● Cellular duplexer

	Tx	Rx	Tx to Rx (min)
Pass Band	824~849MHz	869~894 MHz	
Insertion Loss	2.5dB max	3.0dB max	
VSWR	2.5 max	2.3 max	
Attenuation	42dB min (869~894MHz)	50dB min (824~849MHz)	53dB (824~849MHz) 43dB (869~894MHz)

1.2.3 LNAs (U110)

The RFL6000(U110) is the integrated cellular and PCS LNA chipset. The characteristics of Low Noise Amplifier (LNA) are low noise figure, high gain, high intercept point and high reverse isolation. The frequency selectivity characteristic of mobile phone is mostly determined by LNA.

The specification of LG-TM250 LNAs are described below:

Parameter	Low gain		Mid gain		Max gain		Units
	Cellular	PCS	Cellular	PCS	Cellular	PCS	
Gain	-19	-20	-2	-9	15.5	16	dB
Noise Figure	19	20	2	9	1.4	1.6	dB
Input IP3	25	25	20	20	10	8	dBm

1.2.4 GPS LNA and Mixers (U111)

The RFR6000 device performs signal down-conversion for Cellular, PCS and GPS tri-band applications. It contains all the circuitry (with the exception of external filters) needed to support conversion of received RF signals to baseband signals. The three downconverting Mixers (Cellular, PCS and GPS), and an LO Buffer Amplifier to buffer the RF VCO to the RF Transmit Upconverter. The GPS LNA & mixers offer the most advanced and integrated CDMA Rx solution designed to meet cascaded Noise Figure (NF) and Third-order Intercept Point (IIP3) requirements of IS-98C and J-STD-018 specifications for Sensitivity, Two-Tone Intermodulation, and Single-tone Desense.

Operation modes and band selection are specially controlled from the Mobile Station Modem MSM6050.

The specification of LG-TM250 Mixers are described below:

Parameter	Low gain		High gain		Units
	Cellular	PCS	Cellular	PCS	
Noise Figure	27	27	10	10	dB
Input IP3	4	3	6	6	dBm
Input IP2	50	50	70	70	dBm

1.2.5 Rx RF SAW FILTER(F110, F111, F112)

The main function of Rx RF SAW filter is to attenuate mobile phone spurious frequency, attenuate noise amplified by the LNA and suppress second harmonic originating in the LNA.

1.3 Description of Transmit Part Circuit

1.3.1 RFT6100 (U155)

The RFT6100 baseband-to-RF Transmit Processor performs all Tx signal-processing functions required between digital baseband and the Power Amplifier Modulator (PAM). The baseband quadrature signals are upconverted to the Cellular or PCS frequency bands and amplified to provide signal drive capability to the PAM. The RFT6100 includes an mixers for up-converting analog baseband to RF, a programmable PLL for generating Tx and Rx LO frequency, cellular and PCS driver amplifiers and Tx power control through an 85 dB VGA. As added benefit, the single sideband upconversion eliminates the need for a band pass filter normally required between the upconverter and driver amplifier.

I, I/, Q and Q/ signals proceed from the MSM6050 to RFT6100 are analog signal. In CDMA mode, These signals are modulated by Offset Quadrature Phase Shift King (OQPSK). I and Q are 90 deg. out of phase, and I and I/ are 180 deg. The mixers in RFT6100 converts baseband signals into RF signals. After passing through the upconverters, RF signal is inputted into the Power AMP.

- RFT6100 Cellular and PCS CDMA RF Specifications

	Condition	Min.	Typ.	Max.	Units
Rated Output Power	Average CDMA Cellular		8		dBm
	Average CDMA PCS		10		dBm
Min Output Power	Average CDMA Cellular		-80		dBm
	Average CDMA PCS		-78		dBm
Rx band noise power	CDMA Cellular		-133		dBm/Hz
	CDMA PCS		-132		
ACPR	Cellular: $F_c \pm 885\text{kHz}$		-56		dBc/
	PCS: $F_c \pm 1.25\text{MHz}$		-56		30kHz

1.3.2 Power Amplifier(U414,U415)

The power amplifier that can be used in the PCS and CDMA mode has linear amplification capability and high efficiency. For higher efficiency, it is made up of one MMIC (Monolithic Microwave Integrated Circuit) for

which RF input terminal and internal interface circuit are integrated onto one IC after going through the GaAs HBT (heterojunction bipolar transistor) process. The module of power amplifier is made up of an output end interface circuit including this MMIC. The maximum power that can be inputted through the input terminal is +7dBm and conversion gain is about 28dB. RF transmit signals that have been amplified through the power amplifier are sent to the duplexer.

1.4 Description of Frequency Synthesizer Circuit

1.4.1 Voltage Control Temperature Compensation Crystal Oscillator (VCTCXO, U141)

The temperature variation of mobile phone can be compensated by TCXO. The reference frequency of a mobile phone is -30~+85 °C. The receives frequency tuning signals called TRK_LO_ADJ from MSM as 0.5V~2.5V DC via R and C filter in order to generate the reference frequency of 19.2 MHz and input it into the frequency synthesizer. Frequency stability depending on temperature is ± 2.0 ppm.

1.4.2 Voltage Controlled Oscillator (VCO, U140)

The external VCO signal is processed by the LO generation and distribution circuits in RFR6000 to create the PCS and Cellular quadrature downconverter's LO signals. Likewise, the internal VCO signal of RFR6000 is processed to create the GPS quadrature downconverter's LO signal. In all cases, the LO signals applied at the mixer ports are at the frequency different than the VCO frequency. This assures that the VCO frequency is different than the RF frequency, an important consideration for Zero-IF processing. The VCO frequency used are 1715.56~1768.89 MHz for PCS and 1738.08~1787.94 MHz for cellular and they are produced in single voltage controlled oscillator of U140.

2. Digital/Voice Processing Part

2.1 Overview

The digital/voice processing part processes the user's commands and processes all the digital and voice signal processing in order to operate in the phone. The digital/voice processing part is made up of a keypad/LCD, receptacle part, voice processing part, mobile station modem part, memory part, and power supply part.

2.2 Configuration

2.2.1 Keypad/LCD and Receptacle Part

This is used to transmit keypad signals to MSM6050. It is made up of a keypad backlight part that illuminates the keypad, LCD part that displays the operation status onto the screen, and a receptacle that receives and sends out voice and data with external sources.

2.2.2 Voice Processing Part

The voice processing part is made up of an audio codec used to convert MIC signals into digital voice signals and digital voice signals into analog voice signals, amplifying part for amplifying the voice signals and sending them to the ear piece, amplifying part that amplifies ringer signals coming out from MSM6050, and amplifying part that amplifies signals coming out from MIC and transferring them to the audio processor.

2.2.3 MSM (Mobile Station Modem) 6050 Part

MSM is the core elements of CDMA terminal and carries out the functions of CPU, interleaver/deinterleaver, Viterbi encoder/decoder, modulator/demodulator, and vocoder.

2.2.4 Memory Part

The memory part is made up of a flash memory, pseudo-SRAM for storing data.

2.2.5 Power Supply Part

The power supply part is made up of circuits for generating various types of power, used for the digital/voice processing part.

2.3 Circuit Description

2.3.1 Keypad/LCD and Receptacle Part

Once the keypad is pressed, the key signals are sent out to MSM6050 for processing. In addition, when the key is pressed, the keypad/LCD lights up through the use of 9 LEDs. The terminal status and operation are displayed on the screen for the user with the characters and icons on the LCD (16 characters × 4 lines, 1 line icon).

Moreover, it exchanges audio signals and data with external sources through the receptacle, and then receives power from the battery or external batteries.

2.3.2 Audio Processing Part

MIC signals are amplified through OP AMP, inputted into the audio codec(included in MSM6050) and converted into digital signals. Oppositely, digital audio signals are converted into analog signals after going through the audio codec. These signals are amplified at the audio amplifier and transmitted to the ear-piece. The signals from MSM6050 activate the ringer by using signals generated in the timer in MSM6050.

2.3.3 MSM Part

MSM6050 is the core element of CDMA system terminal that includes ARM7TDMI microprocessor core. It supports both CDMA and Digital FM, operating in both the cellular and PCS spectrums. The subsystems within the MSM6050 include a CDMA processor, a DFM processor, a multi-standard Vocoder, an integrated CODEC with earpiece and microphone amplifiers, general-purpose ADC for subsystem monitoring, an ARM7TDMI microprocessor, and both Universal Serial Bus(USB) and an RS-232 serial interfaces supporting forward and reverse link CDMA2000 1x data communications of 153.6 Kbps simultaneously. And it also contains complete digital modulation and demodulation systems for CDMA standards, as specified in IS-95-A/B/C.

In MSM, coded symbols are interleaved in order to cope with multi-path fading. Each data channel is scrambled by the long code PN sequence of the user in order to ensure the confidentiality of calls. Moreover, binary quadrature codes are used based on walsh functions in order to discern each channel. Data created thus are 4-phase modulated by one pair of Pilot PN code and they are used to create I and Q data.

When received, I and Q data are demodulated into symbols by the demodulator, and then de-interleaved in reverse to the case of transmission. Then, the errors of data received from viterbi decoder are detected and corrected. They are voice-decoded at the vocoder in order to output digital voice data.

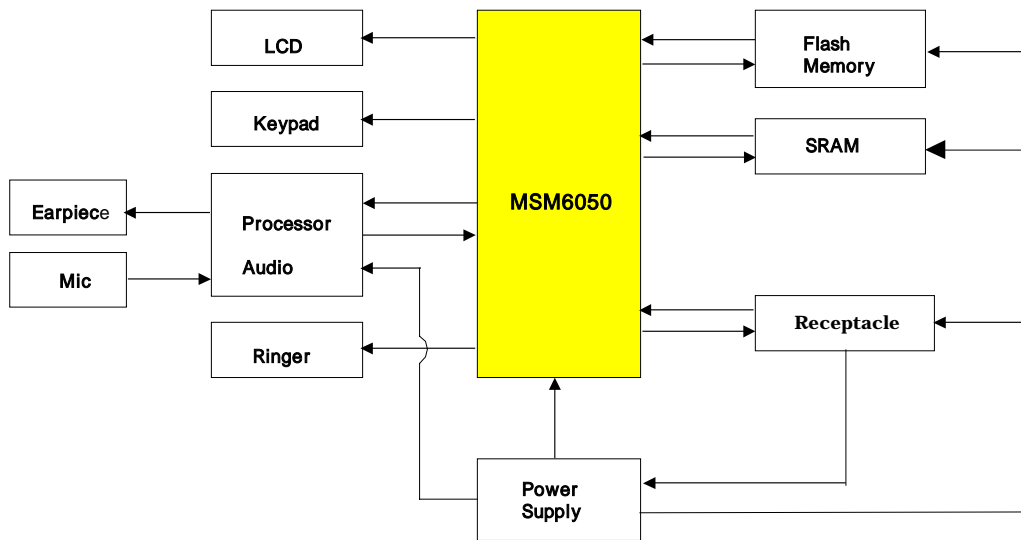

[Figure 2-2] Block Diagram of Digital/Voice Processing Part

2.3.4 Memory Part

MCP contains 32 Mbits flash memory and 32 Mbits pseudo-SRAM. In the Flash Memory part of MCP are programs used for terminal operation. The programs can be changed through down loading after the assembling of terminals. On the SRAM data generated during the terminal operation are stored temporarily.

2.3.5 Power Supply Part

When the battery voltage (+3.7V) is fed and the PWR key of keypad is pressed, Q401 is activated by the ON_SW signal, and then the control signal P_EN is generated. Based on this P_EN, the regulators U403, U404, U407 (LDOs for MSM) are operated and 1.9V_MSMC & 2.8V_MSMP, 2.6V_MSMA are generated.

The Rx part regulator(U405) is operated by the control signal SLEEP/ from MSM6050

The Tx part regulator(U401) is operated by the control signal IDLE/ from MSM6050.

2.3.6 Logic Part

The logic part consists of internal CPU of MSM and MCP. The MSM6050 receives TCXO (=19.2MHz) from U141 and controls the phone in both CDMA and FM modes. The major components are as follows:

CPU : ARM7TDMI microprocessor core

MCP(Flash Memory + SRAM) :U202(TH50VSF5585ADSB)

- FLASH ROM : 32Mbits
- STATIC RAM : 32Mbits
-
- **CPU**

The ARM7TDMI microprocessor includes a 3 stage pipelined RISC architecture, both 32-bit ARM and 16-bit THUMB instruction sets, a 32-bit address bus, and a 32-bit internal data bus. It has a high performance and low power consumption.

- **MCP**

Flash ROM is used to store the terminal's program. Using the down-loading program, the program can be changed even after the terminal is fully assembled.

SRAM is used to store the internal flag information, call processing data, and timer data.

- **KEYPAD**

For key recognition, key matrix is setup using key sense 0~4 signals and GPIO 56~61 of output ports of MSM. Nine LEDs and backlight circuitry are included in the keypad for easy operation in the dark.

- **LCD MODULE**

LCD module contains a controller which will display the information onto the LCD by 8-bit data from the MSM6050. It is also supplied stable 2.8V_MSMP by regulator(U403) for fine view angle and LCD reflects to improve the display efficiency. 4 LEDs are used to display LCD backlight.

CHAPTER 4. Trouble Shooting

1. When power isn't "Turn On".

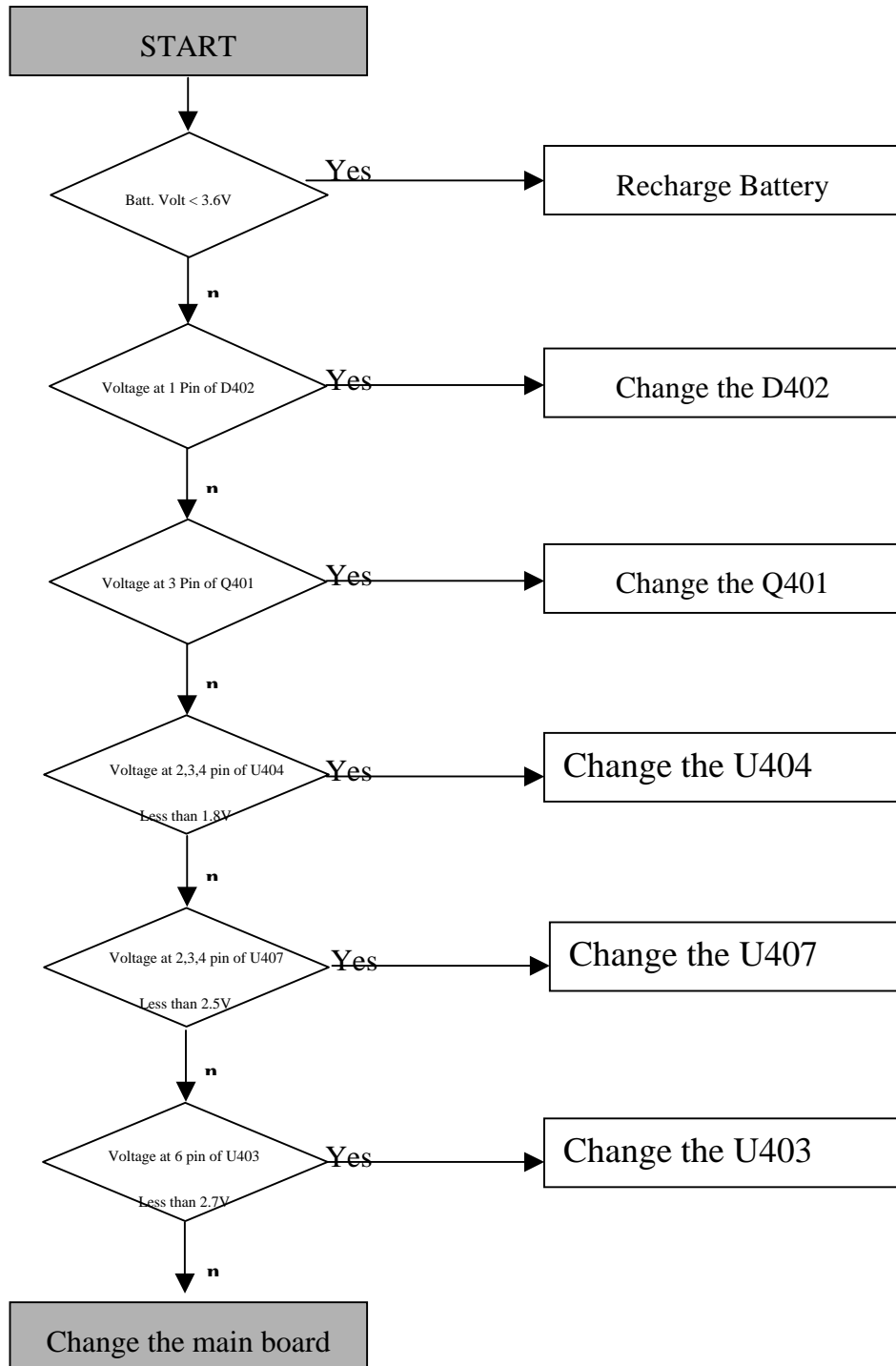

2. When LCD isn't displayed.

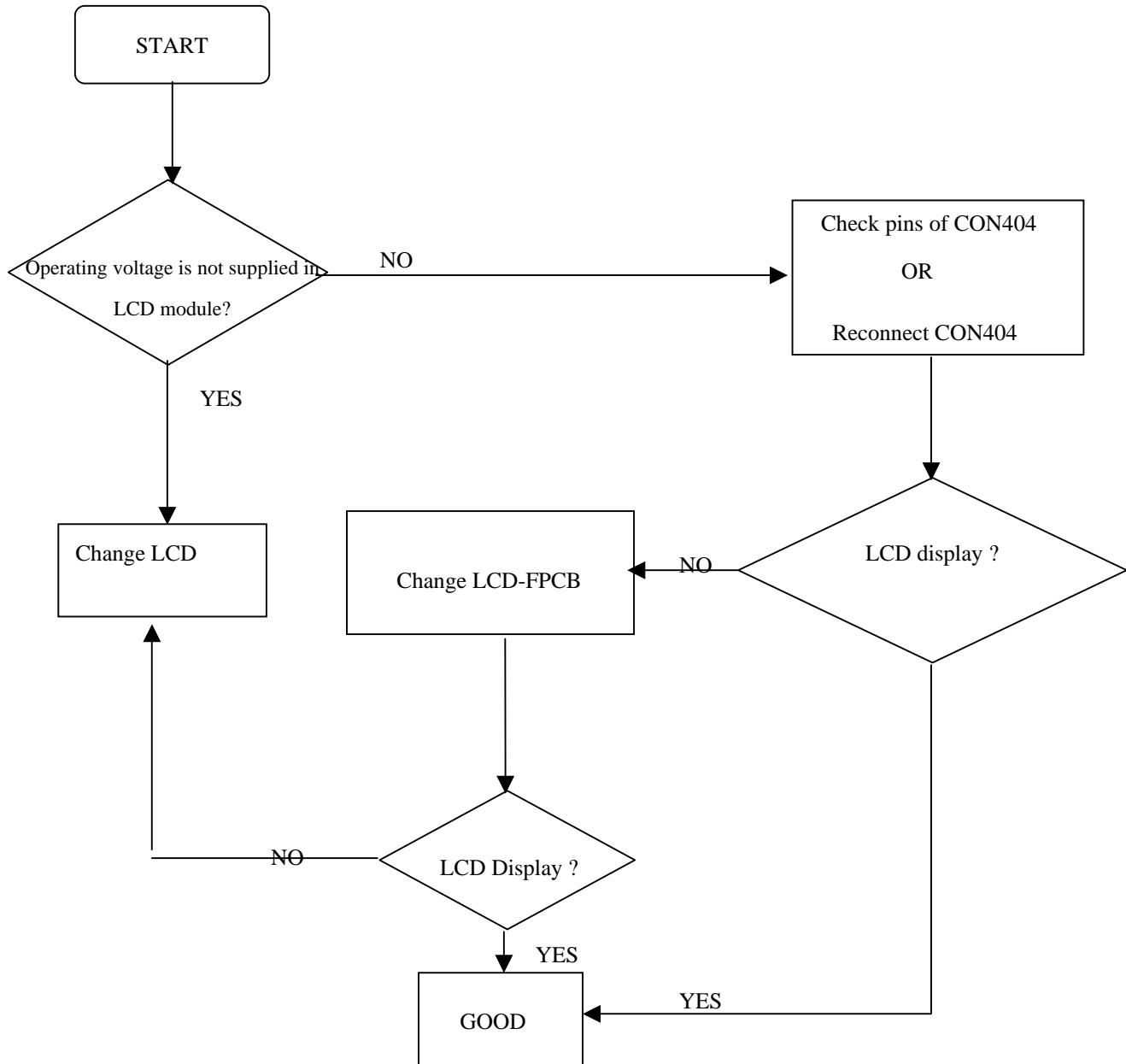

3. When Tx Audio (MIC) isn't transmitted.

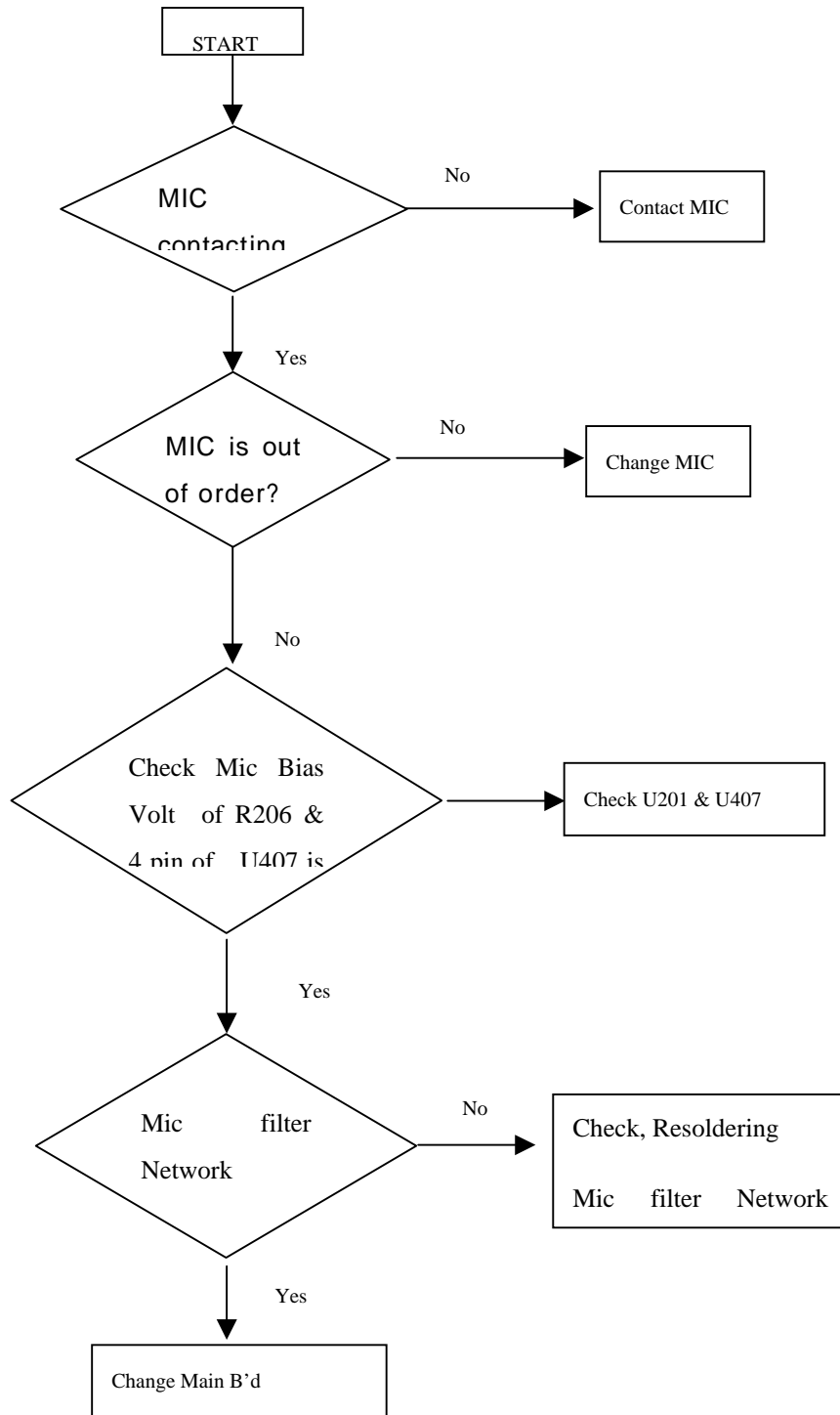

4. When Rx Audio (Speaker) isn't heard.

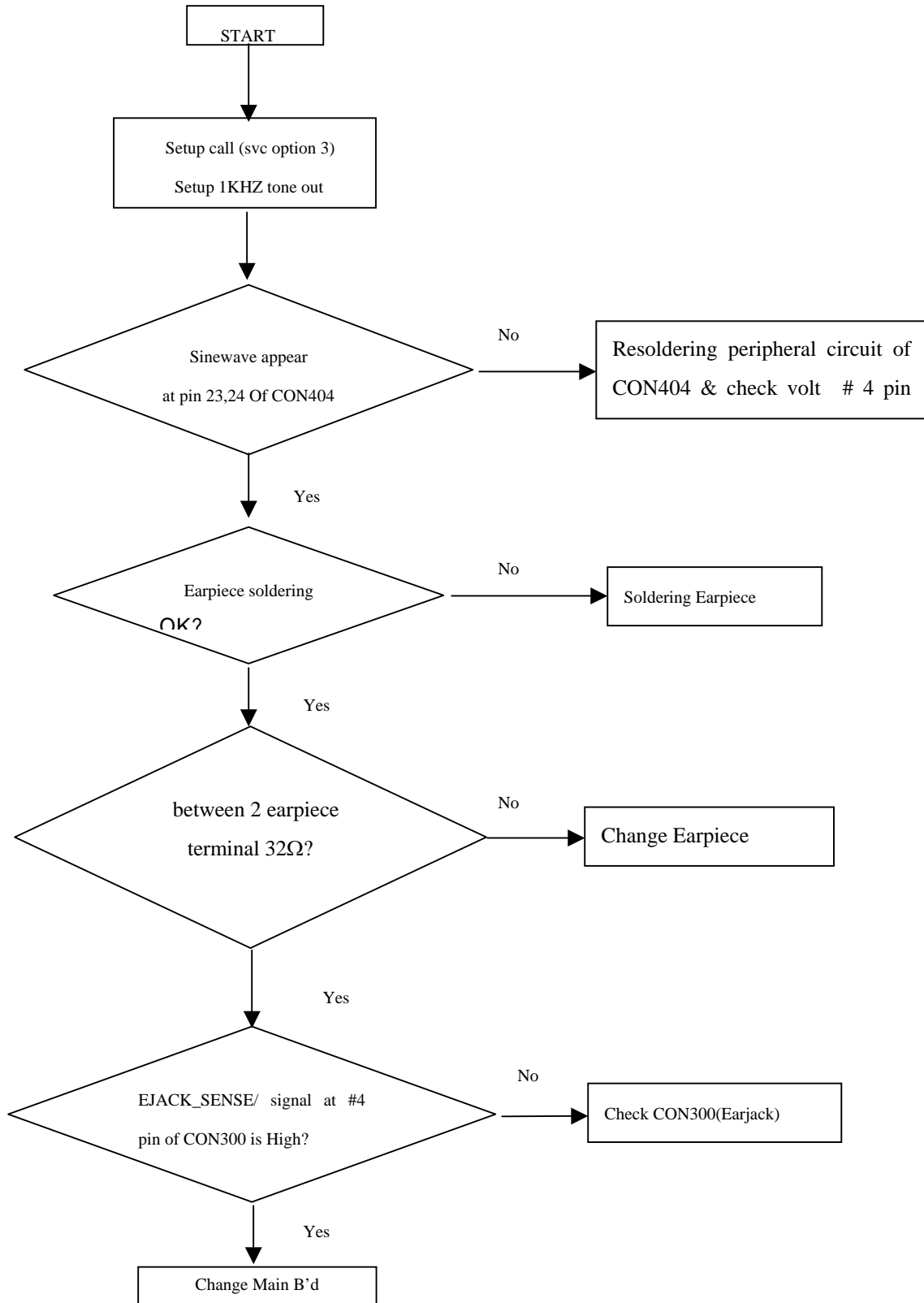

5. When Keytone isn't heard.

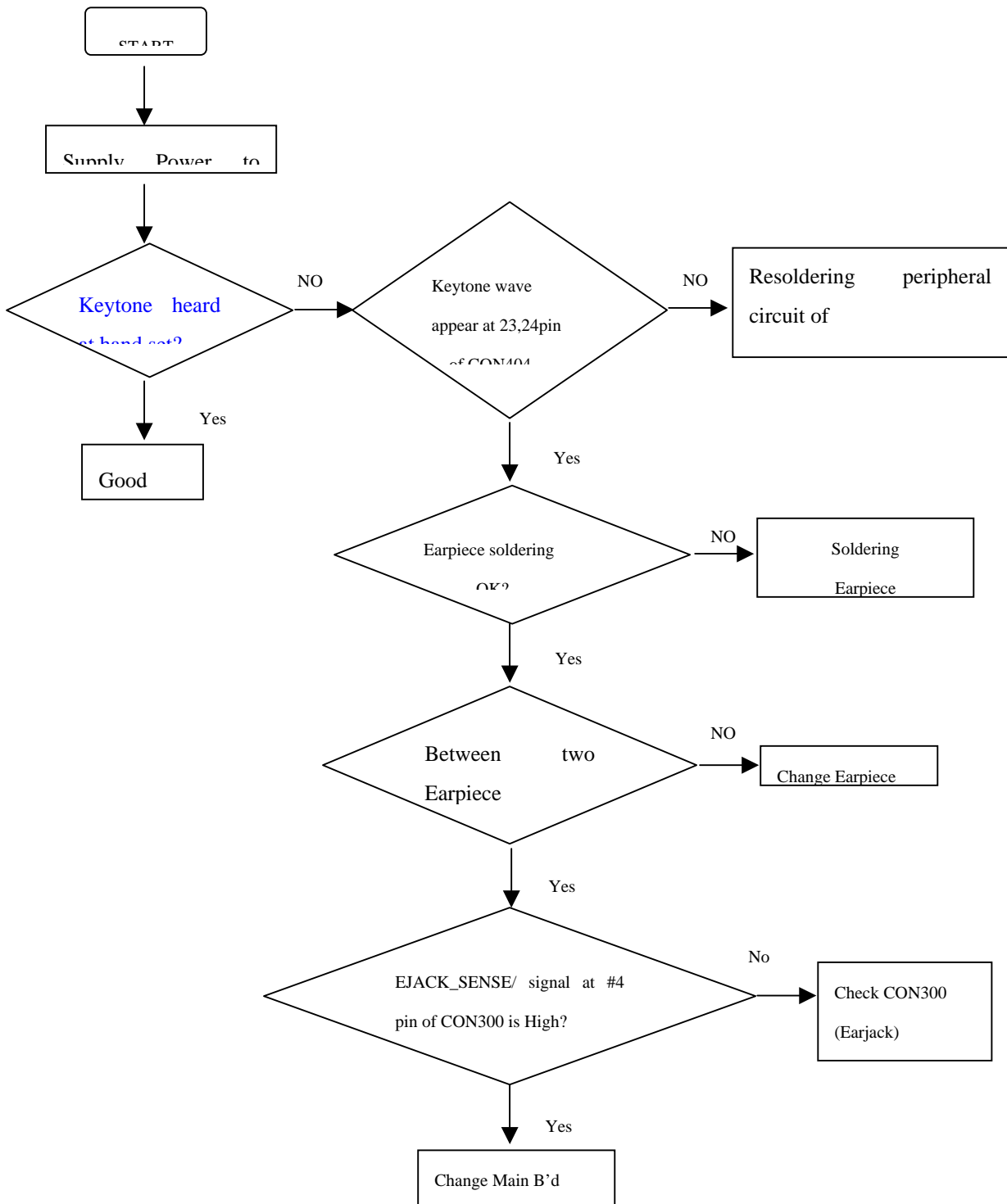

6. When Buzzer isn't rung.

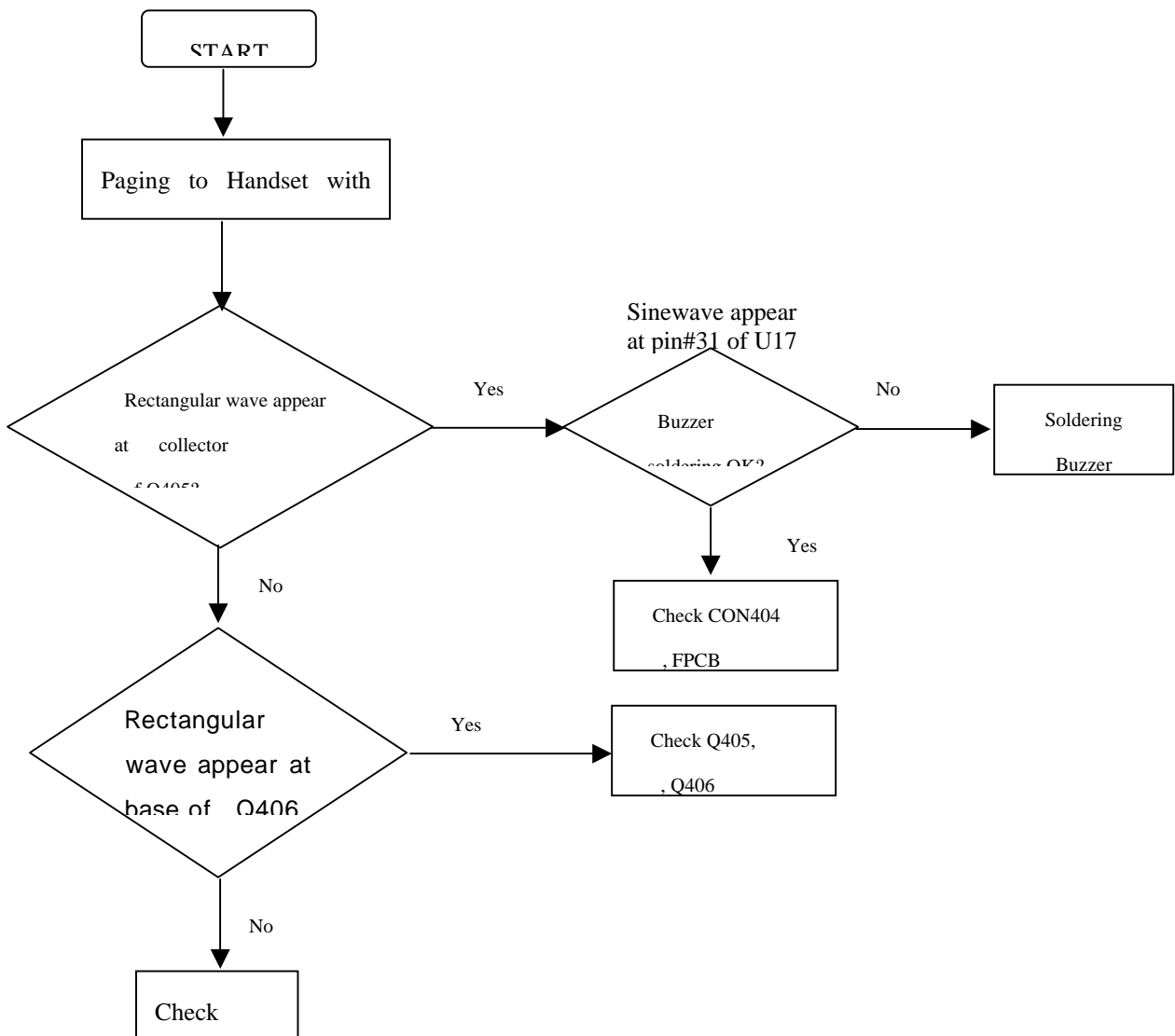

7. When Cellular CDMA Tx carrier isn't transmitted.

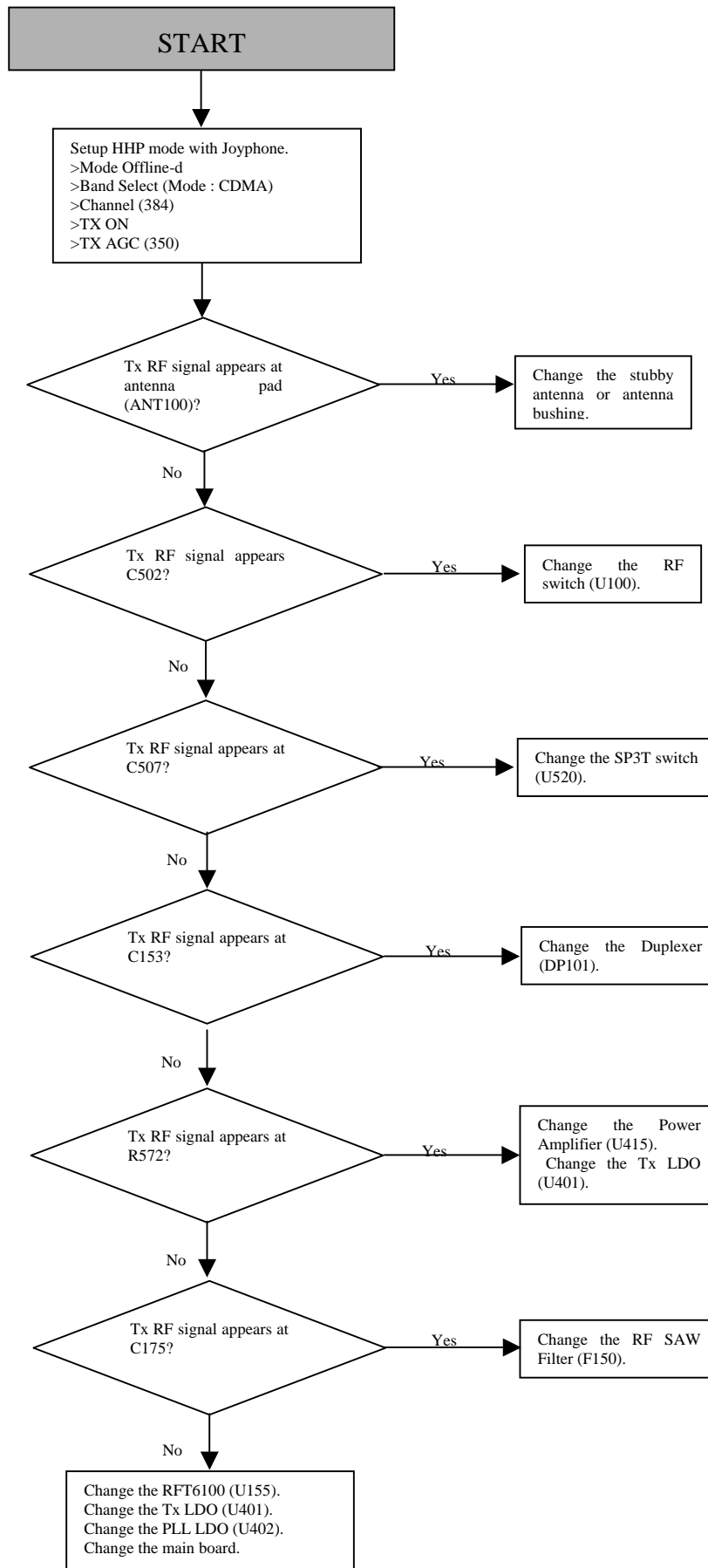

8. When PCS Tx carrier isn't transmitted.

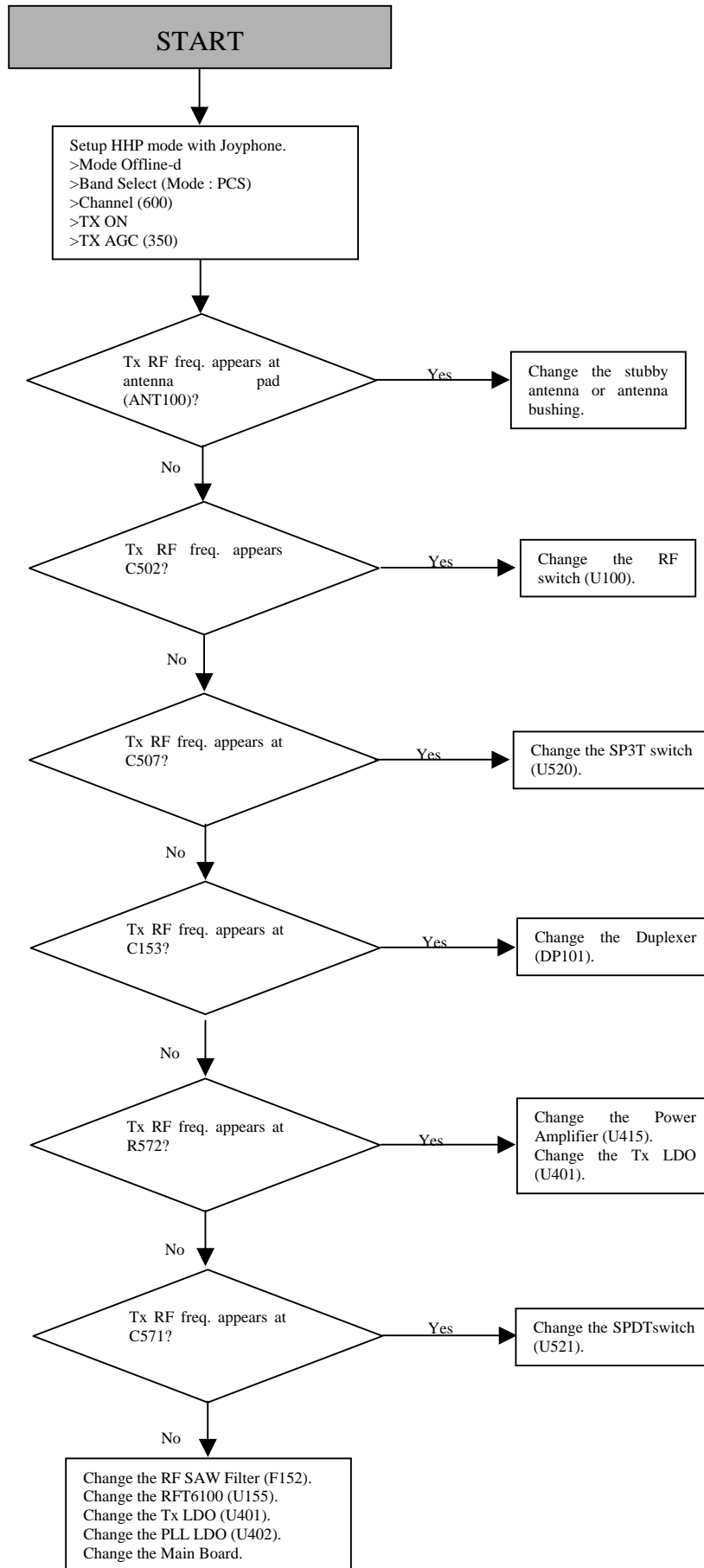

9. When Cellular Rx sensitivity isn't normal.

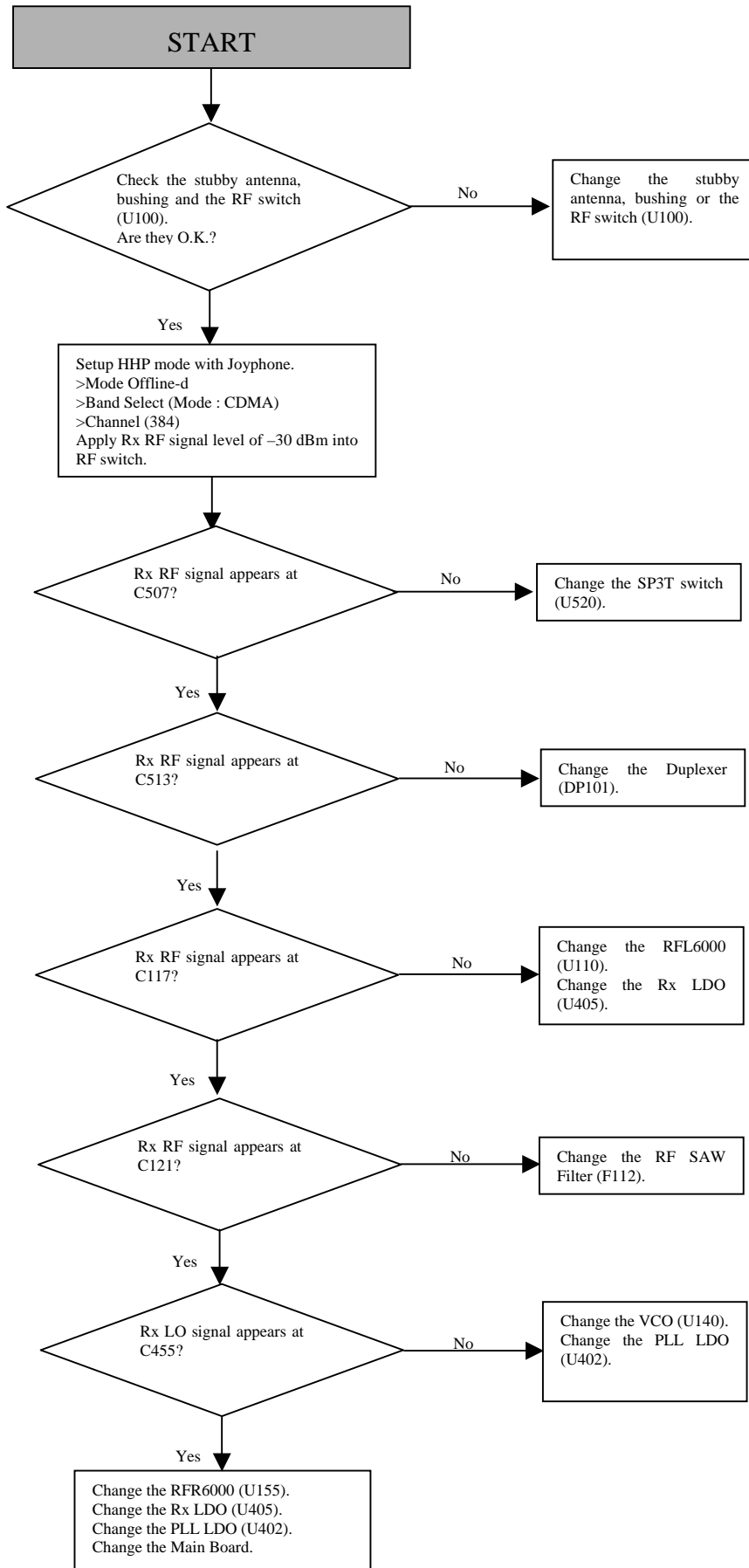

10. When PCS Rx sensitivity isn't normal.

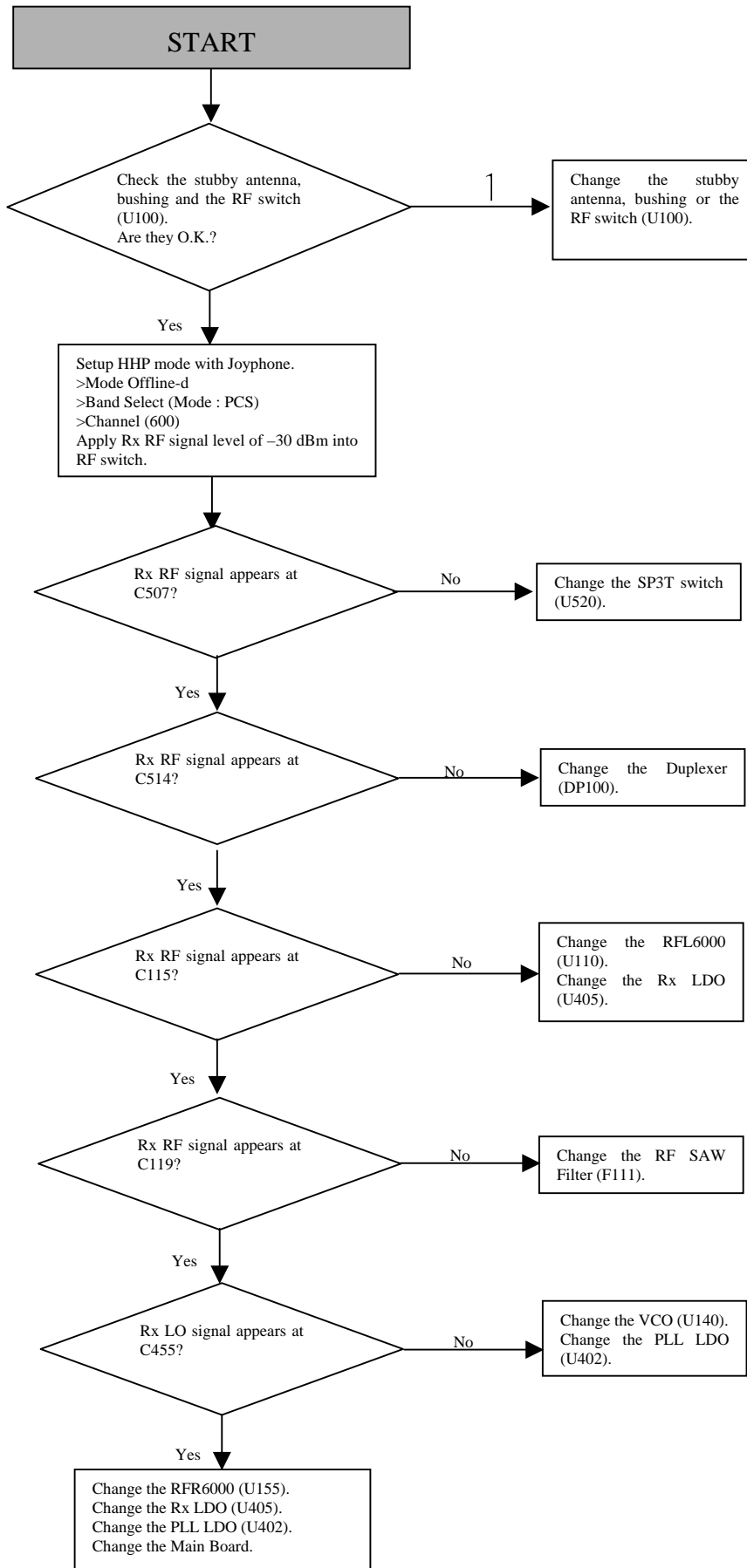

CHAPTER 5. Safety

IMPORTANT

Read This Information Before Using Your Hand-Held Portable Cellular Telephone

First introduction in 1984, the hand-held portable cellular telephone is one of the most exciting and innovative electronic products ever developed.

With it you can stay in contact with your office, your home, emergency service, and others. For the safe and efficient operation of your phone, observe these guidelines.

Your cellular phone is a radio transmitter and receiver. When it is ON, it receives and also sends out radio frequency (RF) energy. The phone operates in the frequency range of 824 MHz to 894 MHz and employs commonly used CDMA techniques. When you use your phone, the cellular system handling your calls controls the power level at which your phone transmits. The power level can range from 0.00001 milli-Watt to 200 milli-Watt.

Exposure to Radio Frequency Energy

In 1991 the Institute of Electrical and Electronics Engineers (IEEE), and in 1992 the American National Standards Institute (ANSI) updates the 1982 ANSI Standard for safety levels with respect to human exposure to RF energy. Over 120 scientists, engineers, and physicians from universities, government health agencies, and industry, after reviewing the available body of research, developed this updated Standard. In March, 1993, the US Federal Communications Commission (FCC) proposed the adoption of this updated Standard.

The design of your phone complies with this updated Standard. Of course, if you want to limit RF exposure even further than the updated ANSI Standard, you may choose to control the duration of your calls and operation your phone in the most power efficient manner.

Efficient Phone Operation

For your phone to operate at the lowest power level, consistent with satisfactory call quality, please observe the following guidelines:

If your phone has an extendable antenna, extend it fully. Some models allow you to place a call with the antenna retracted. However, your phone operates more efficiently with the antenna fully extended.

Hold the phone as you would any other telephone. While speaking directly into the mouthpiece, position the antenna up and over your shoulder.

Do not hold the antenna when the phone is "IN USE". Holding the antenna affects call quality and may cause the phone to operate at a higher power level than needed.

Antenna Care and Replacement

Do not use the phone with a damaged antenna. If a damaged antenna comes into contact with skin, a minor burn may result. Replace a damaged antenna immediately. Consult your manual to see if you may change your antenna yourself. If so, use only a manufacturer approved antenna. Otherwise, take your phone to a qualified service center for repair.

Use only the supplied or approved antenna. Non-approved antennas, modifications, or attachments, could impair call quality, damage the phone, and violate FCC regulations.

Driving

Check the laws and regulations on the use of cellular telephones in the areas where you drive. Always obey them. Also, when using your phone while driving, please:

Give full attention to the driving. Use hands-free operation, if available, and pull off the road and park before making or answering a call if driving conditions require.

Electronic Devices

Most modern electronic equipment is shielded from RF energy. However, RF energy from cellular telephones may affect inadequately shielded electronic equipment.

RF energy may affect improperly installed or inadequately shielded electronic operating and entertainment system in motor vehicles. Check with the manufacturer or its representative to determine if these systems are adequately shielded from external RF energy. You should check with the manufacturer of any equipment that has been added to your vehicle.

Consult the manufacturer of any personal medical devices (such as pacemakers, hearing aids, etc.) to determine if they are adequately shielded from external RF energy.

Turn your phone OFF in health care facilities. When any regulations posted in the areas instruct you to do so. Hospitals or health care facilities may be using equipment that could be sensitive to external RF energy.

Aircraft

Turn your phone OFF before boarding any aircraft.

Use it on the ground only with crew permission. Do not use it in the air.

To prevent possible interference with aircraft systems, US Federal Aviation Administration (FAA) regulations require you to have permission from a crew member to use your phone while the plane is on the ground. Using your phone while the plane is in the air.

Children

Do not allow children to play with your phone. It is not a toy. Children could hurt themselves or others (by poking themselves or others in the eye with the antenna, for example). Children also could damage the phone, or make calls that increase your telephone bills.

Blasting Areas

To avoid interfering with blasting operations, turn you unit OFF when in a “blasting area” or in areas posted “Turn off two-way radio”. Construction crews often use remote control RF devices to set off explosives.

Potentially Explosive Atmospheres

Turn your phone OFF when in any area with a potentially explosive atmosphere. It is rare, but your phone or accessories could generate sparks. Sparks in such area could cause an explosion or fire resulting in bodily injury or even death.

Areas with a potentially explosive atmosphere are often, but not always, clearly marked. They include fueling areas such as gas station; below deck on boats; fuel or chemical transfer or storage facilities; areas where the air contains chemical or particles, such as grain, dust, or metal powders; and any other area where you would normally be advised to turn off your vehicle engine.

Do not transport or store flammable gas, liquid, or explosives in the compartment of your vehicle which contains your phone or accessories.

Vehicles using liquefied petroleum gas (such as propane or butane) must compl7y with the National Fire Protection Standard (NFPA-58). For a copy of this standard, contact the National Fire Protection Association, One Battery march Park, Quincy, MA 02269, Attn: Publication Sales Division.

Rule of Thumb: Using common sense at all times when handling, installing or using the phone. Any questions should be directed to you nearest Service Center or authorized service technician or electrician.

CHAPTER 6. Glossary

General Terms

Abbreviated Alert. An abbreviated alert is used to remind the mobile station user that previously selected alternative routing features are still active.

AC. See Authentication Center.

Access Attempt. A sequence of one or more access probe sequences on the Access Channel containing the same message. See also Access Probe and Access Probe Sequence.

Access Channel. A Reserve CDMA Channel used by mobile stations for communicating to the base station. The Access Channel is used for short signaling message exchanges such as call origination's, responses to pages, and registrations. The Access Channel is a slotted random access channel.

Access Channel Message. The information part of an access probe consisting of the message body, length field, and CRC.

Access Channel Message Capsule. An Access Channel message plus the padding.

Access Channel Preamble. The preamble of an access probe consisting of a sequence of all-zero frames that is sent at the 4800bps rate.

Access Channel Request Message. An Access Channel message that is autonomously generated by the mobile station. See also Access Channel Response Message.

Access Channel Response Message. A message on the Access Channel generated to reply to a message received from the base station.

Access Channel Slot. The assigned time interval for an access probe. An Access Channel slot consists of an integer number of frames. The transmission of an access probe is performed within the boundaries of an Access Channel slot.

Access Probe. One Access Channel transmission consisting of a preamble and a message. The transmission is an integer number of frames in length and transmits one Access Channel message. See also Access Probe Sequence and Access Attempt.

Access Probe Sequence. A sequence of one or more access probes on the Access Channel. The same Access Channel message is transmitted in every access probe of an access attempt. See also Access Probe and Access Attempt.

Acknowledgement. A Layer 2 response by the mobile station or the base station confirming that a signaling message was received correctly.

Action Time. The time at which the action implied by a message should take effect.

Active Set. The set of pilots associated with the CDMA Channels containing Forward Traffic Channels assigned to a particular mobile station.

Aging. A mechanism through which the mobile station maintains in its Neighbor Set the pilots that have been recently sent to it from the base station and the pilots whose handoff drop timers have recently expired.

A-key. A secret, 64-bit pattern stored in the mobile station. It is used to generate update the mobile station's Shared Secret Data. The A-key is used in the mobile station authentication process.

Analog Access Channel. An analog control channel used by a mobile station to access a system to obtain service.

Analog Color-Code. An analog signal (see Supervisory Audio Tone) transmitted by a base station on an analog voice channel and used to detect capture of a mobile station by an interfering base station or the capture of a base station by an interfering mobile station.

Analog Control Channel. An analog channel used for the transmission of digital control information from a base station to a mobile station or from a mobile station to a base station.

Analog Paging Channel. A forward analog control channel that is used to page mobile stations and send orders.

Analog Voice Channel. An analog channel on which a voice conversation occurs and on which brief digital messages may be sent from a base station to a mobile station or from a mobile station to a base station.

Authentication. A procedure used by a base station to validate a mobile station's identity.

Authentication Center (AC). An entity that manages the authentication information related to the mobile station.

Authentication Response (AUTHR). An 18-bit output of the authentication algorithm. It is used, for example, to validate mobile station registrations, origination and terminations. A method of registration in which the mobile station registers without an explicit command from the base station.

AWGN. Additive White Gaussian Noise.

Bad Frames. Frames classified as erasures (frame category 10) or 9600bps frames, primary traffic only with bit errors (frame category 9). See also Good Frames.

Base Station. A station in the Domestic Public Cellular Radio Telecommunications Service, other than a mobile station, used for communicating with mobile stations. Depending upon the context, the term base station may refer to a cell, a sector within a cell, an MSC, or other part of the cellular system. See also MSC.

Base Station Authentication Response (AUTHBS). An 18-bit pattern generated by the authentication algorithm. AUTHBS is used to confirm the validity of base station orders to update the Shared Secret Data.

Base Station Random Variable (RANDBS). A 32-bit random number generated by the mobile station for authenticating base station orders to update the Shared Secret Data.

BCH Code. See Bose-Chaudhuri-Hocquenghem Code.

Busy-Idle Bits. The portion of the data stream transmitted by a base station on a forward analog control channel that is used to indicate the current busy-idle status of the corresponding reverse analog control channel.

Call Disconnect. The process that releases the resources handling a particular call. The disconnect process beings either when the mobile station user indicates the end of the call by generating an on-hook condition or other call release mechanism, or when the base station initiates a release.

Call History Parameter(COUNT). A modulo-64 event counter maintained by the mobile station and Authentication Center that us used for clone detection.

Candidate Set. The set of pilots that have been received with sufficient strength by the mobile station to be successfully demodulated, but have not been placed in the Active Set by the base station. See also Active Set, Neighbor Set, and Remaining Set.

. See Code Division Multiple Access

CDMA Channel. The set of channels transmitted between the base station within a given CDMA frequency assignment. See also Forward CDMA Channel and Reverse CDMA Channel.

CDMA Channel Number. An 11-bit number corresponding to the center of the CDMA frequency assignment.

CDMA Frequency Assignment. A 1.23MHz segment of spectrum centered on one of the 30KHz channels of the existing analog system.

Code Channel. A subchannel of a Forward CDMA Channels. A Forward CDMA Channel contains 64 code channels. Code channel zero is assigned to the Pilot Channel. Code channels 1 through 7 may be assigned to the either Paging Channels or the Traffic Channels. Code Channel 32 may be assigned to either a Sync Channel or a Traffic Channel. The remaining code channels may be assigned to Traffic Channels.

Code Division Multiple Access (CDMA). A technique for spread-spectrum multiple-access digital communications that creates channels through the use of unique code sequences.

Code Symbol. The output of an error-correcting encoder. Information bits are input to the encoder and code symbols are output from the encoder. See Convolutional Code.

Continuous Transmission. A mode of operation in which Discontinuous Transmission is not permitted.

Control Mobile Attenuation Code(CMAC). A 3-bit field in the Control-Filler Message that specifies the maximum authorized power level for a mobile transmitting on an analog reverse control channels.

Convolution Code. A type of error-correcting code. A code symbol can be considered as the convolution of the input data sequence with the impulse response of a generator function.

CRC. See Cyclic Redundancy Code.

Cyclic Redundancy Code (CRC). A class of linear error detecting codes which generate parity check bits by finding the remainder of a polynomial division.

Data Burst Randomizer. The function that determines which power control groups within a frame are transmitted on the Reverse Traffic Channel when the data rate is lower than 9600 bps. The data burst randomizer determines, for each mobile station, the pseudo random position of the transmitted power control groups in the frame while guaranteeing that every modulation symbol is transmitted exactly once.

DBc. The ratio(in dB) of the sideband power of a signal, measured in a given bandwidth at a given frequency offset from the center frequency of the same signal, to the total inband power of the signal. For CDMA, the total inband power of the signal is measured in a 1.23MHz bandwidth around the center frequency of the CDMA signal.

DBm. A measure of power expressed in terms of its ration (in dB) to one milliwatt.

DBm/Hz. A measure of power spectral density. DBm/Hz is the power in one Hertz of bandwidth. Where power is expressed in units of dBm.

DBW. A measure of power expressed in terns of its ration (in dB) to one Watt.

Dedicated Control Channel. An analog control channel used for the transmission of digital control information from either a base station or a mobile station.

Deinterleaving. The process of unpermuting the symbols that were permuted by the interleaver..

Deinterleaving is performed on received symbols prior to decoding.

Digital Color Code(DCC). A digital signal transmitted by a base station on a forward analog control channel that is used to detect capture of a base station by an interfering mobile station.

Dim-and-Burst. A frame in which primary traffic is multiplexed with either secondary traffic or signaling traffic.

Discontinuous Transmission (DTX). A mode of operation in which a mobile station transmitter autonomously switches between two transmitter power levels while the mobile station is in the conversation state on an analog voice channel.

Distance-Based Registration. An autonomous registration method in which the mobile station registers whenever it enters a cell whose distance from the cell in which the mobile station last registered exceeds a given threshold.

DTMF. See Dual Tone Multifrequency.

Dual-Tone Multifrequency(DTMF). Signaling by the simultaneous transmission of two tones, one from a group of low frequencies and another from a group of high frequencies. Each group of frequencies consists of four frequencies.

Eb. The energy of an information bit.

Ec/I0. The ratio in (dB) between the pilot energy accumulated over one PN chip period(E_c) to the power spectral density in the received bandwidth(I_0).

Effective Radiated Power (ERP). The transmitted power multiplied by the antenna gain referenced to a half wave dipole.

Electronic Serial Number(ESN). A 32-bit number assigned by the mobile station manufacturer, uniquely identifying the mobile station equipment.

Encoder Tail Bits. A fixed sequence of bits added to the end of a block of data to reset the convolutional encoder to a known state.

ERP. See Effective Radiated Power.

ESN. See Electronic Serial Number.

Extended Protocol. An optional expansion of the signaling message between the base station and mobile station to allow for the addition of new system features and operational capabilities.

Fade Timer. A timer kept by the mobile station as a measure of Forward Traffic Channel continuity. If the Fade timer expires, the mobile station drops the call.

Flash. An indication sent on an analog voice channel or CDMA Traffic Channel indicating that the user Directed the mobile station to invoke special processing.

Foreign NID Roamer. A mobile station operating in the same system (SID) but a different network (NID) from the one in which service was subscribed. See also Foreign SID Roamer and Roamer.

Foreign SID Roamer. A mobile station operating in a system (SID) other than the one from which service was subscribed. See also Foreign NID Roamer and Roamer.

Forward Analog Control Channel (FOCC). An analog voice channel used from a base station to a mobile

station.

Forward Analog Voice Channel (FVC). An analog voice channel used from a base station to a mobile station.

Forward CDMA Channel. A CDMA Channel from a base station to mobile stations. The Forward CDMA Channel contains one or more code channels that are transmitted on a CDMA frequency assignment using a Particular pilot PN offset. The code channels are associated with the Pilot Channel, Sync Channel, Paging Channels, and Traffic Channels. The Forward CDMA Channel always carries a Pilot Channel and may carry up to one Sync Channel, up to seven Paging Channels, and up to 63 Traffic Channels, as long as the total number of channels, including the Pilot Channel, is no greater than 64.

Forward Traffic Channel. A code channel used to transport user and signaling traffic from the base station to the mobile station.

A basic timing interval in the system. For the Access Channel, Paging Channel, and Traffic Channel, a frame is 20 ms long. For the Sync Channel, a frame is 26.666...ms long.

Frame Category. A classification of a received Traffic Channel frame based upon transmission data rate, the Frame contents (primary traffic, secondary traffic, or signaling traffic), and whether there are detected error in the frame.

Frame Offset. A time skewing of Traffic Channel frames from System Time in integer multiples of 1.25 ms. The maximum frame offset is 18.75 ms..

Frame Quality Indicator. The CRC check applied to 9600 bps and 4800 bps Traffic Channel frames.

Global Positioning System (GPS). A US government satellite system that provides location and time Information to users. See Navstar GPS Space segment / Navigation User interfaces ICD-GPS-200 for Specifications.

Half Frame. A 10 ms interval on the paging Channel. Two half frames comprise a frame, the first half frame begins at the same time as the frame.

Handoff. The of transferring communication whth a station mobile station from one base station to another.

Hard Handoff. A handoff characterized by a temporary disconnection of the Traffic Channel. Hard handoffs Occur when the mobile station is transferred between disjoint Active Sets, the CDMA frequency assignment changes, the frame offset changes, or the mobile station is directed from a CDMA Traffic Channel to an analog voice channel, See also Soft Handoff.

Hash Function. A function used by the mobile station to select one out of N available resource. The hash function distributes the available resources uniformly among a random sample of mobile stations.

HLR. See Home Location Register.

Home Location Register (HLR). The location register to which a MIN is assigned for record purposes such as subscriber information.

Home System. The cellular system in which the mobile station subscribes for service.

Idle Handoff. The act of transferring reception of the Paging Channel from one base station to another, when the mobile station is in the *Mobile Station Idle State*.

Implicit Registration. A registration achieved by a successful transmission of an origination or page response on the Access Channel.

Interleaving. The process of permuting a sequence of symbols.

kHz. Kilohertz (10^3 Hertz).

ksps. Kilo-symbols per second (10^3 symbols per second).

Layer 1. See Physical Layer.

Layer 2. Layer 2 provides for the correct transmission and reception of signaling messages, including partial duplicate detection. See also Layering and Layer 3.

Layer 3. Layer 3 provides the control of the cellular telephone systems. Signaling messages originate and terminate at layer 3. See also Layering and Layer 2.

Local Control. An optional mobile station feature used to perform manufacturer-specific functions.

A PN sequence with period $2^{42}-1$ that is used for scrambling on the Forward CDMA Channel and spreading on the Reverse CDMA Channel. The long code uniquely identifies a mobile station on both the Reverse Traffic Channel and the Forward Traffic Channel. The long code provides limited privacy. The long code also separates multiple Access Channels on the same CDMA channel. See also Public Long Code and Private Long Code.

Long Code Mask. A 42-bit binary number that creates the unique identity of the long code. See also Public Long Code, Private Long Code, Public Long Code Mask, and Private Long Code Mask.

LSB. Least significant bit.

Maximal Length Sequence (m-Sequence). A binary sequence of period 2^n-1 , n a positive integer, with no internal periodicities. A maximal length sequence can be generated by a tapped n -bit shift register with linear feedback.

Mcps. Megachips per second (10^6 chips per second).

Mean Input Power. The total received calorimetric power measured in a specified bandwidth at the antenna connector, including all internal and external signal and noise sources.

Mean Output Power. The total transmitted calorimetric power measured in a specified bandwidth at the

antenna connector when the transmitter is active.

Message. A data structure that conveys control information or application information. A message consists of a length field (MSG_LENGTH), a message body (the part conveying the information), and a CRC.

Message Body. The part of the message contained between the length field (MSG_LENGTH) and the CRC field.

Message Capsule. A sequence of bits comprising a single message and padding. The padding always follows the message and may be of zero length.

Message CRC. The CRC associated with a message. See also Cyclic Redundancy Check.

Message Field. A basic named element in a message. A message field may consist of zero or more bits.

Message Record. An entry in a message consisting of one or more field that repeats in the message.

MHz. Megahertz.(10^6 Herz)

MIN. See Mobile Station Identification Number.

Mobile Protocol Capability Indicator (MPCI). A 2-bit field used to indicate mobile station's capabilities.

Mobile Station. A station in the Domestic Public Cellular Radio Telecommunications Service intended to be used while in motion or during halts at unspecified points. Mobile station include portable units (e.g., handheld personal units) and units installed in vehicles.

Mobile Station Class. Mobile station classes define mobile station characteristics such as slotted operation and transmission power.

Mobile Station Identification Number (MIN). The 34-bit number that is a digital representation of the 10-digit directory telephone number assigned to a mobile station.

Mobile Station Originated Call. A call originating from a mobile station.

Mobile Station Terminated Call. A call received by a mobile station (not to be confused with a disconnect or call release).

Mobile Switching Center (MSC). A configuration of equipment that provides cellular radiotelephone service. Also called the Mobile Telephone Switching Office (MTSO)

Modulation Symbol. The output of the data modulator before spreading. On the Reverse Traffic Channel, 64-ary orthogonal modulation is used and six code symbol (when the data rate is 9600bps) or each repeated code symbol (when the data rate is less than 9600bps) is one modulation symbol.

Ms. Millisecond.

MSB. Most significant bit.

MSC. See Mobile Switching Center.

Multiplex Option. The ability of the multiplex sublayer and lower layer to be tailored to provide special capabilities. A multiplex option defines such characteristics as the frame format and the rate decision rules. See also Multiplex Sublayer.

Multiplex Sublayer. One of the conceptual layers of the system that multiplexes and demultiplexes primary traffic, secondary traffic, and signaling traffic.

NAM. See Number Assignment Module.

Narrow Analog. A type of voice channel that uses 10kHz channel spacing and subaudible signaling.

Neighbor Set. The set of pilots associated with the CDMA Channel that are probable candidates for handoff. Normally, the Neighbor Set consists of the pilots associated with CDMA Channel that cover geographical areas near the mobile station. See also Active Set, Candidate Set, and Remaining Set.

- A network is a subset of a cellular system, such as an area-wide cellular network, a private group of base stations, or a group of base stations set up to handle a special requirement. A network can be as small or as large as needed, as long as it is fully contained within a system. See also System.

Network Identification (NID). A number that uniquely identifies a network within a cellular system. See also System Identification.

NID. See Network Identification.

Non-Autonomous Registration. A registration method in which the base station initiates registration. See also Autonomous Registration.

Non-Slotted Mode. An operation mode of the mobile station in which the mobile station continuously monitors the Paging Channel when in the Mobile Station Idle State.

Ns. Nanosecond.

NULL. Not having any value.

Null Traffic Channel Data. One or more frames of 16 '1's followed by eight '0's sent at the 1200bps rate. Null Traffic Channel data is sent when no service option is active and no signaling message is being sent. Null Traffic Channel data serves to maintain the connectivity between the mobile station and the base station.

Number Assignment Module (NAM). A set of MIN-related parameters stored in the mobile station.

Numeric Information. Numeric information consists of parameters that appear as numeric fields in message exchanged by the base station and the mobile station and information used to describe the operation of the mobile station.

OLC. See Overload Class (CDMA) or Overload Control (analog).

Optional Field. A field defined within a message structure that is optionally to the message recipient.

Order. A type of message that contains control codes for either the mobile station or the base station.

Ordered Registration. A registration method in which the base station orders the mobile station to send registration related parameters.

Overhead Message. A message sent by the base station on the Paging Channel to communicate base-station-specific and system-wide information to mobile station.

Overload Class. The means used to control system access by mobile stations, typically in emergency or other overload conditions. Mobile station are assigned one (or more) of sixteen overload classed, Access to the CDMA system can then be controlled on a per class basis by persistence values transmitted by the base station.

Overload Control (OLC). A means reverse analog control channel accesses by mobile stations. Mobile station are assigned one(or more) of sixteen control levels. Access is selectively restricted by a base station setting one or more OLC bits in the Overload Control Global Action Message.

Packet. The unit of information exchanged between the service option applications of the base station and the mobile station.

Padding. A sequence of bits used to fill from the end of a message to the end of a message capsule, typically to

the end of the frame or half frame. All bits in the padding are '0'.

Paging. The act of seeking a mobile station when a call has been placed to that mobile station.

Paging Channel (Analog). See Analog Paging Channel.

Paging Channel (CDMA). A code channel in a Forward CDMA Channel used for transmission of control information and pages from a base station to a mobile station.

Paging Channel Slot. An 80ms interval on the Paging Channel. Mobile station operating in the slotted mode are assigned specific slots in which they monitor messages from the base station.

Parameter-Change Registration. A registration method in which the mobile station registers when certain of its stored parameters change.

Parity Check Bits. Bits added to a sequence of information bits to provide error detection, correction, or both.

Persistence. A probability measure used by the mobile station to determine if it should transmit in a given Access Channel Slot.

Physical Layer. The part of the communication protocol between the mobile station and the base station that is responsible for the transmission and reception of data. The physical layer in the transmitting station is presented a frame by the multiplex sublayer and transforms it into an over-the-air waveform. The physical layer in the receiving station transforms the waveform back into a frame and presents it to the multiplex sublayer above it.

Pilot Channel. An unmodulated, direct-sequence spread spectrum signal transmitted continuously by each CDMA base station. The Pilot Channel allows a mobile station to acquire the timing of the Forward CDMA Channel, provides a phase reference for coherent demodulation, and provides a means for signal strength comparisons between base stations for determining when to handoff.

Pilot PN Sequence. A pair of modified maximal length PN sequences with period 2^{15} used to spread the Forward CDMA Channel and the Reverse CDMA Channel. Different base stations are identified by different pilot PN sequence offsets.

Pilot PN Sequence Offset Index. The PN offset in units of 64 PN chips of a pilot, relative to the zero offset pilot PN sequence.

PN Chip. One bit in the PN sequence.

PN Sequence. Pseudonoise sequence. A periodic binary sequence.

Power Control Bit. A bit sent in every 1.25ms interval on the Forward Traffic Channel to signal the mobile station to increase or decrease its transmit power.

Power Control Group. A 1.25ms interval on the Forward Traffic Channel and the Reverse Traffic Channel. See also Power Control Bit.

Power-Down Registration. An autonomous registration method in which the mobile station registers on power up.

PPM. Parts per million.

Preamble. See Access Channel Preamble and Traffic Channel Preamble.

Primary CDMA Channel. A CDMA Channel at a pre-assigned frequency assignment used by the mobile station for initial acquisition. See also Secondary CDMA Channel.

Primary Paging Channel (CDMA). The default code channel (code channel 1) assigned for paging on a

CDMA Channel.

Primary Traffic. The main traffic stream carried between the mobile station and the base station, supporting the active promaty service option, on the Traffic Channel. See also Secondary Traffic, Signaling Traffic, and Servic3e Option.

Private Long Code. The long code characterized by the private long code mask. See also Long Code.

Private Long Code Mask. The long code mask used to form the private long code. See also Public Long Code Mask and Long Code.

Public Long Code. The long code characterized by the public long code mask.

Public Long Code Mask. The long code mask used to form the private long code. The mask contains the ESN of the mobile station. See also Private Long Code Mask and Long Code.

Punctured Code. An error-correcting code generated from another error-correcting code by deleting (i.e., puncturing) code symbols from the code output.

Quick Repeats. Additional transmissions of identical copies of a message within a short interval to increase the probability that the message is received correctly.

Receive Objective Loudness Rating (ROLR). A perceptually weighted transducer gain of telephone receivers relating electrical excitation from a reference generator to sound pressure at the earphone. The receive objective loudness tating is normally specified in dB relative to one Pascal per millivolt. See IEEE Standard 269-1992, IEEE Standard 661-1979, CCITT Recommendation P.76, and CCITT Recommendation P.79.

Registration. The process by which a mobile station identifies its location and parameters to a base station.

Registration Zone. A collection of one or more base stations treated as a unit when determining whether a mobile station should perform zone-based registration.

Release. A process that the mobile station and base station use to inform each other of call disconnect.

The set of all allowable pilot offsets as determined by PILOT_INC, excluding the pilot offsets of the pilots in the Active Set, Candidate Set, and Neighbor Set. See also Active Set, Candidate Set, and Neighbor Set.

Request. A layer 3 message generated by either the mobile station or the base station to retrieve information, ask for service, or command an action.

Response. A layer 3 message generated as a result of another message, typically a request.

Reverse Analog Control (RECC). The analog control channel used from a mobile station to a base station.

Reverse Analog Voice Channel (RVC). The analog voice channel used from a mobile station to a base station.

Reverse CDMA Channel. The CDMA Channel from the mobile station to the base station. From the base station's perspective, the Reverse CDMA Channel is the sum of all mobile station transmissions on a CDMA frequency assignment.

Reverse Traffic Channel. A Reverse CDMA Channel used to transport user and signaling traffic from a single mobile station to one or more base stations.

Roamer. A mobile station operating in a cellular system (or network) other than the one from which service was subscribed. See also Foreign NID Roamer and Foreign SID Roamer.

ROLR. See Receive Objective Loudness Rating.

SAT. See Supervisory Audio Tone.

Scan of Channels. The procedure by which a mobile station examines the signal strength of each forward analog control channel.

SCI. Synchronized Capsule Indicator bit.

Search Window. The range of PN sequence offsets that a mobile station searches for a pilot.

Secondary CDMA Channel. A CDMA Channel at a preassigned frequency assignment used by the mobile station for initial acquisition. See also Primary CDMA Channel.

Secondary Traffic. An additional traffic stream that can be carried between the mobile station and the base station on the Traffic Channel. See also Primary Traffic and Signaling Traffic.

Seizure Precursor. The initial digital sequence transmitted by a mobile station to a base station on a reverse analog control channel.

Seizure Option. A service capability of the system. Service options may be applications such as voice, data, or facsimile.

Shard Secret Data (SSD). A 128-bit pattern stored in the mobile station (in semi-permanent memory) and known by the base station. SSD is a concatenation of two 64-bit subsets: SSD_A, which is used to support the authentication procedures and SSD_B, which serves as one of the inputs to the process generating the encryption mask and private long code.

Short Message Services (SMS). A suite of services which include SMS Text Delivery, Digital Paging (i.e., Call Back Number – CBN), and Voice Mail Notification (VMN).

SID. See System Identification.

Signaling Tone. A 10kHz tone transmitted by a mobile station on an analog voice channel to: 1) confirm orders, 2) signal flash requests, and 3) signal release requests.

Signal Traffic. Control message that are carried between the mobile station and base station on the Traffic Channel. See also Primary Traffic and Secondary Traffic.

Slot Cycle. A periodic interval at which a mobile station operating in the slotted monitors the Paging Channel.

Slotted Mode. An operation mode of the mobile station in which the mobile station monitors only selected slots on the Paging Channel when in the Mobile Station Idle State.

Soft Handoff. A handoff occurring while the mobile station is in the Mobile Station Control on the Traffic Channel State. This handoff is characterized by commencing communications with a new base station on the same CDMA frequency assignment before terminating communications with the old base station. See also Hard Handoff.

SOM. Start-of-Message Bit.

SPS. Symbols per second.

- An identification of certain characteristics of a mobile station. Classes are defined in Table 2.3.3-1.

Status Information. The following status information is used to describe mobile station operation when using the analog system.

- Serving-System Status. Indicates whether a mobile station is turned to channels associated with System A or System B.

- **First Registration ID Status.** A status variable used by the mobile station in association with its processing of received Registration ID messages.
- **First Location Area ID Status.** A status variable used by the mobile station in association with its processing of received Location Area ID messages.
- **Location Registration ID Status.** A status variable used by the mobile station in association with its processing of power-up registration and location-based registration.
- **First Idle ID Status.** A status variable used by the mobile station in association with its processing of the Idle Task.
- **Local Control Status.** Indicates whether a mobile station must respond to local control messages.
- **Roam Status.** Indicates whether a mobile station is in its home system.
- **Termination Status.** Indicates whether a mobile station must terminate the call when it is on an analog voice channel.

Supervisory Audio Tone (SAT). One of three tones in the 6 kHz region that is transmitted on the forward analog voice channel by a base station and transponder on the reverse analog voice channel by as mobile station.

Supplementary Digital Color Code (SDCC1, SDCC2). Additional bits assigned to increase the number of color codes from four to sixty four, transmitted on the forward analog control channel.

Symbol. See Code Symbol and Modulation Symbol.

Sync Channel. [Code channel 32 in the Forward CDMA Channel which transports the synchronization message to the mobile station.](#)

Sync Channel Superframe. An 80ms interval consisting of three Sync Channel frames (each 26.666...ms in length).

System. A system is a cellular telephone service that covers a geographic area such as a city, Metropolitan region, country, or group of countries. See also Network.

System Time. The time reference used by the system. System Time is synchronous to UTC time(except for leap seconds) and used the same time origin as GPS time. Offset by the propagation delay from the base station to the mobile station. See also Universal coordinated Time.

Timer-Based Registration. A registration method in which the mobile station registers whenever a counter reaches a predetermined value. The counter is incremented an average of once per 80 ms period.

Time Reference. A reference established by the mobile station that is synchronous with the earliest arriving multipath component used for demodulation.

TOLR. See Transmit Objective Loudness Rating.

Traffic Channel. A communication path between a mobile station and base station used for user and signaling traffic. The term Traffic Channel implies a Forward Traffic Channel and Reverse Traffic Channel pair. See also Forward Traffic Channel and Reverse Traffic Channel.

Traffic Channel Preamble. A sequence of all-zero frames that is sent at the 9600 bps rate by the mobile station on the Reverse Traffic Channel. The Traffic Channel preamble is sent during initialization of the Traffic

Channel.

Transmit Objective Loudness Rating(TOLR). A perceptually weighted transducer gain of telephone transmitters relation sound pressure at the microphone to voltage at a reference electrical termination. It is normally specified in dB relative to one millivolt per Pascal. See IEEE Standard 269-1992, IEEE Standard 661-1979, CCITT Recommendation P.76 , and CCITT Recommendation. P.79

Unique Challenge-Response Procedure. An exchange of information between a mobile station and a base station for the purpose of confirming the mobile station's identity. The procedure is initiated by the base station and is characterized by the use of a challenge-specific random number(i.e., RANDU) instead of the random variable broadcast globally(RAND).

Unique Random Variable(RANDU). A 24-bit random number generated by the base station in support of the Unique Challenge-Response procedure.

Universal Coordinated Time(UTC). An internationally agreed-upon time scale maintained by the Bureau International de l'Heure(BIH) used as the time reference by nearly all commonly available time and frequency distribution systems i.e., WWW, WWVH, LORAN-C, Transit, Omega, and GPS.

UTC. Universal Temps Coordine. See Universal Coordinated Time.

Voice Channel. See Analog Voice Channel.

Voice Mobile Attenuation Code(VMAC). A 3-bit field in the Extended Address Word commanding the initial mobile power level when assigning a mobile station to an analog voice channel.

Voice Privacy. The process by which user voice transmitted over a CDMA Traffic Channel is afforded a modest degree of protection against eavesdropping over the air.

Walsh Chip. The shortest identifiable component of a Walsh function. There are 2^N Walsh chips in one Walsh function where N is the order of the Walsh function. On the Forward CDMA channel one Walsh chip equals 1/1.2288MHz, or 813.802...ns. On the Reverse CDMA Channel, one Walsh chip equals 4/1.2288MHz, or 3.255... μ s.

Walsh Function. One of 2^N time orthogonal binary functions (note that the functions are orthogonal after mapping '0' to 1 and '1' to -1).

Zone-Based Registration. An autonomous registration method in which the mobile station registers whenever it enters a zone that is not in the mobile station's zone list.

μ s. Microsecond

Appendix

1. Assembly and Disassembly Diagram
2. Block & Circuit Diagram
3. Part List
4. Component Layout
5. Accessories
 - Desktop Charger
 - AC Adapter
 - Battery
 - Travel Charger
 - Hands-Free Car Kit (Portable)
 - Cigarette Lighter Charger
 - Data Cable Kit
 - Headset
 - USB Cable Kit
 - Holster